

## Owner's Manual

**Model No.**  
16611008000  
CE800ENT

- Assembly
- Operation
- Adjustments
- Parts
- Warranty

### **CAUTION:**

Read and understand this manual before operating unit

# ***SPIRIT***



**Retain For Future  
Reference**

# TABLE OF CONTENTS

Product Registration .....	2
Safety Precautions .....	4
Important Safety Instructions.....	5
Important Electrical Instructions .....	6
Important Operation Instructions .....	7
Assembly Instructions .....	9
Operation of Your Console.....	16
Using a Heart Rate Transmitter.....	39
General Maintenance.....	40
Exploded View Diagram.....	41
Parts List.....	42
Getting On/Off Your Elliptical .....	45
Training Guidelines .....	47
Stretching.....	51
Manufacturer's Limited Warranty.....	53

***Thank you for purchasing our product, please save these instructions. Please do not perform or attempt any customizing, adjustments, repair or maintenance that is not described in this manual.***

# ***SPIRIT***

**CONGRATULATIONS ON YOUR  
NEW ELLIPTICAL AND WELCOME  
TO THE SPIRIT FAMILY!**

Thank you for your purchase of this quality elliptical from Dyaco Canada Inc. Your new elliptical was manufactured by one of the leading fitness manufacturers in the world and is backed by one of the most comprehensive warranties available. Through your dealer, Dyaco Canada Inc. will do all we can to make your ownership experience as pleasant as possible for many years to come. The local dealership where you purchased this elliptical is your administrator for all warranty and service needs. Their responsibility is to provide you with the technical knowledge and service personnel to make your experience more informed and any difficulties easier to remedy.

Please take a moment at this time to record the name of the dealer, their telephone number, and the date of purchase below to make any future needed contact easy. We appreciate your support, and we will always remember that you are the reason that we are in business.

Please go to [www.dyaco.ca/warranty.html](http://www.dyaco.ca/warranty.html) and complete the online warranty registration.

Yours in Health,  
Dyaco Canada Inc.

**Name of Dealer** \_\_\_\_\_

**Telephone Number of Dealer** \_\_\_\_\_

**Purchase Date** \_\_\_\_\_

## ***Product Registration***

### **RECORD YOUR SERIAL NUMBER**

Please record the Serial Number of this fitness product in the space provided below.

**Serial Number** \_\_\_\_\_

### **REGISTER YOUR PURCHASE**

Please visit us at [www.dyaco.ca/warranty.html](http://www.dyaco.ca/warranty.html) to register your purchase.

## BEFORE YOU BEGIN

Thank you for choosing the SPIRIT CE800ENT Elliptical. We take great pride in producing this quality product and hope it will provide many hours of quality exercise to make you feel better, look better, and enjoy life to its fullest. It's a proven fact that a regular exercise program can improve your physical and mental health. Too often, our busy lifestyles limit our time and opportunity to exercise. The SPIRIT CE800ENT Elliptical provides a convenient and simple method to begin your assault on getting your body in shape and achieving a happier and healthier lifestyle. Before reading further, please review the drawing below and familiarize yourself with the parts that are labelled.

Read this manual carefully before using the SPIRIT CE800ENT Elliptical. Although Dyaco Canada Inc. constructs its products with the finest materials and uses the highest standards of manufacturing and quality control, there can sometimes be missing parts or incorrectly sized parts. If you have any questions or problems with the parts included with your SPIRIT CE800ENT Elliptical, please do not return the product. Contact us **FIRST!** If a part is missing or defective call us toll-free at 1-888-707-1880. Our Customer Service Staff are available to assist you from 8:30 A.M. to 5:00 P.M. (Eastern Time) Monday through Friday. Be sure to have the name and model number of the product available when you contact us.



# SAFETY PRECAUTIONS

## IMPORTANT SAFETY INFORMATION

### THIS UNIT IS INTENDED FOR HOUSEHOLD USE ONLY READ ALL INSTRUCTIONS BEFORE USING THIS ELLIPTICAL

**CAUTION:** Before starting any exercise program, it is recommended that you consult your physician.

Thank you for purchasing our product. Even though we go to great efforts to ensure the quality of each product we produce, occasional errors and/or omissions do occur. In any event, should you find this product to have either a defective or a missing part, please contact us for a replacement.

This exercise equipment was designed and built for optimum safety. However, certain precautions apply whenever you operate a piece of exercise equipment. Be sure to read the entire manual before assembly and operation of this machine. Also, please note the following safety precautions:

1. Read the OWNER'S OPERATING MANUAL and all accompanying literature and follow it carefully before using your elliptical.
2. It is the responsibility of the owner to ensure that all users of the elliptical exerciser are adequately informed of all precautions.
3. If dizziness, nausea, chest pains, or any other abnormal symptoms are experienced while using this equipment, STOP the workout at once. CONSULT A PHYSICIAN IMMEDIATELY.
4. Inspect your exercise equipment prior to exercising to ensure that all nuts and bolts are fully tightened before each use.
5. The elliptical must be regularly checked for signs of wear and damage. Any part found defective; the part must be replaced with a new spare part from the manufacturer.
6. Fitness equipment must always be installed on a flat surface, do not place the unit on a loose rug or uneven surface. It is recommended to use an equipment mat to prevent the unit from moving while it is being used, which could possibly scratch or damage the surface of your floor. Keep the elliptical exerciser indoors, away from moisture and dust.
7. No changes must be made which might compromise the safety of the equipment.
8. It is recommended to have a minimum of 1' safe clearance around the exercise equipment while in use.
9. Keep children and pets away from this equipment at all times while exercising.
10. Warm-up 5 to 10 minutes before each workout and cool down 5 to 10 minutes afterward. This allows your heart rate to gradually increase and decrease and will help prevent you from straining muscles.
11. Never hold your breath while exercising. Breathing should remain at a normal rate in conjunction with the level of exercise being performed
12. Always wear suitable clothing and footwear while exercising. Do not wear loose-fitting clothing that could become entangled with the moving parts of your elliptical.
13. Always hold the handlebars when mounting, dismounting, or using the elliptical exerciser.
14. Keep your back straight when using the elliptical exerciser; do not arch your back.
15. When you stop exercising, allow the pedals to slowly come to a complete stop. The elliptical exerciser does not have a freewheel; the pedals will continue to move until the flywheel stops.
16. Always unplug the power cord immediately after use and before cleaning the elliptical exerciser.
17. If decals on the elliptical exerciser are missing or illegible, please call our customer service department toll-free at 1-888-707-1880 and order a replacement decal.
18. Care must be taken when lifting or moving the equipment so as not to injure your back. Always use proper lifting techniques
19. User weight should not exceed 450 lbs.

**WARNING:** Before beginning any exercise program, consult your physician. This is especially important for individuals over the age of 35 or persons with pre-existing health problems. Read all instructions before using any fitness equipment. We assume no responsibility for personal injury or property damage sustained by or through the use of this product.

## SAVE THESE INSTRUCTIONS

# IMPORTANT SAFETY INSTRUCTIONS

**WARNING** - Read all instructions before using this equipment.

**DANGER** - To reduce the risk of electric shock, disconnect your elliptical from the electrical outlet prior to cleaning and/or service work.

**WARNING** - To reduce the risk of burns, fire, electric shock, or injury to persons, install the elliptical on a flat level surface with access to a 120-volt, 15-amp grounded outlet with only the elliptical plugged into the circuit.

**DO NOT USE AN EXTENSION CORD UNLESS IT IS A 14 AWG OR BETTER, WITH ONLY ONE OUTLET ON THE END: DO NOT ATTEMPT TO DISABLE THE GROUNDED PLUG BY USING IMPROPER ADAPTERS OR IN ANY WAY MODIFYING THE CORD SET.**

A serious shock or fire hazard may result along with computer malfunctions.

See Grounding Instructions, page 6.

- Do not operate elliptical on deeply padded, plush or shag carpet. Damage to both carpet and elliptical may result.
- Keep children away from the elliptical. There are obvious pinch points and other caution areas that can cause harm.
- Keep hands away from all moving parts.
- Never operate the elliptical if it has a damaged cord or plug. If the elliptical is not working properly, call your dealer.
- Keep the cord away from heated surfaces.
- Do not operate where aerosol spray products are being used or where oxygen is being administered. Sparks from the motor may ignite a highly gaseous environment.
- Never drop or insert any object into any openings.
- Do not use outdoors.
- To disconnect, turn all controls to the off position, then remove the plug from the outlet.
- Please make sure that the power-supply cord is placed in a dry area and kept away from heat.
- Do not attempt to use your elliptical for any purpose other than for the purpose it is intended.
- The hand pulse sensors are not medical devices. Various factors, including the user's movement, may affect the accuracy of heart rate readings. The pulse sensors are intended only as exercise aids in determining heart rate trends in general.
- Wear proper shoes. High heels, dress shoes, sandals or bare feet are not suitable for use on your elliptical. Quality athletic shoes are recommended to avoid leg fatigue.
- Keep children under the age of 13 away from this machine.
- This exercise equipment is not intended for use by persons with reduced physical, sensory or mental capabilities or lack of experience and knowledge.
- Before beginning this or any exercise program, consult a physician. This is especially important for persons over the age of 35 or persons with pre-existing health conditions.
- Close supervision is necessary when this exercise equipment is used by, on, or near children, invalids, or disabled persons.

**SAVE THESE INSTRUCTIONS - THINK SAFETY!**

# IMPORTANT ELECTRICAL INSTRUCTIONS

## WARNING!

**NEVER** remove any cover without first disconnecting AC power. If voltage varies by ten percent (10%) or more, the performance of your elliptical may be affected. Such conditions are not covered under your warranty. If you suspect the voltage is low, contact your local power company or a licensed electrician for proper testing.

**NEVER** expose this elliptical to rain or moisture. This product is NOT designed for use outdoors, near a pool or spa, or in any other high humidity environment. The temperature specification is 40 degrees C, and humidity is 95%, non-condensing (no water drops forming on surfaces).

**Circuit breakers:** Avoid AFCI/GFCI circuit breakers if possible. These breakers may trip occasionally during use because of the high inrush currents from the elliptical drive motor. This condition is an issue with all elliptical and other products with large motors or electric heating elements like ovens.

New laws in your area may require these breakers. If you do have these breakers and outlets in your home and are experiencing nuisance tripping, you should check to see if there are any other devices plugged into the same circuit like fluorescent lights with electronic ballasts, coffee maker, space heater, etc. Optimally the elliptical should be the only device plugged into the circuit.

Our ellipticals have surge suppressors built in to help avoid nuisance tripping. We have tested several AFCI/GFCI breakers and outlets with our products that do not trip when only the elliptical is connected. Brands we have tested are: Eaton (Cutler Hammer Series), Leviton (Smart lock pro) and Schneider Electric (Canadian home series).

## GROUNDING INSTRUCTIONS

**This product must be grounded.** If the elliptical should malfunction or breakdown, grounding provides a path of least resistance for electric current, reducing the risk of electric shock. This product is equipped with a cord having an equipment-grounding plug. The plug must be plugged into an appropriate outlet that is properly installed and grounded in accordance with all local codes and ordinances.

**DANGER** Improper connection of the equipment-grounding conductor can result in a risk of electric shock. Check with a qualified electrician or serviceman if you are in doubt as to whether the product is properly grounded. Do not modify the plug provided with the product if it will not fit the outlet; have a proper outlet installed by a qualified electrician. This product is for use on a nominal 120-volt circuit, and has a grounding plug that looks like the plug illustrated below. A temporary adapter that looks like the adapter illustrated below may be used to connect this plug to a 2-pole receptacle as shown below if a properly grounded outlet is not available. The temporary adapter should be used only until a properly grounded outlet, (Shown below) can be installed by a qualified electrician. The green colored rigid ear-lug, or the like, extending from the adapter, must be connected to a permanent ground such as a properly grounded outlet box cover. Whenever the adapter is used, it must be held in place.

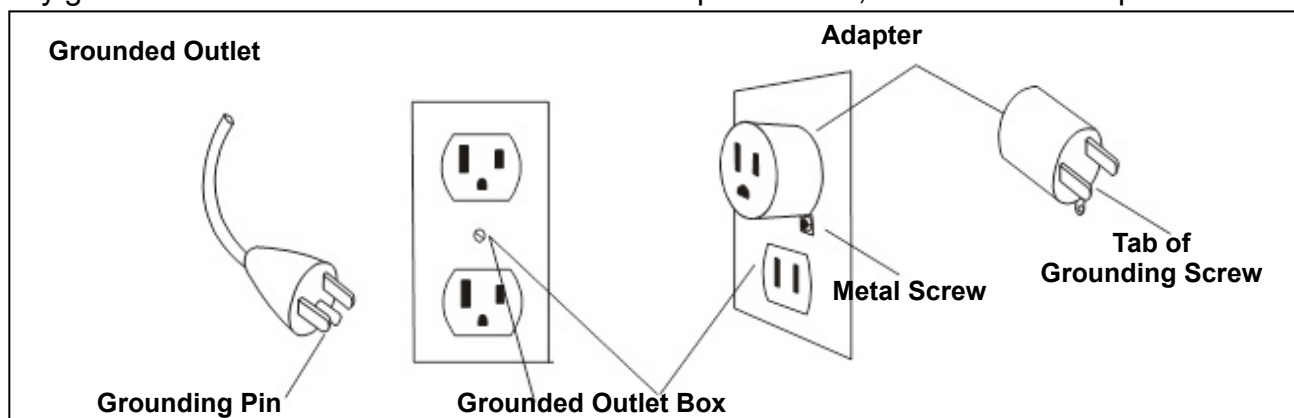

# IMPORTANT OPERATION INSTRUCTIONS

- **NEVER** operate this elliptical without reading and completely understanding the results of any operational change you request from the computer.
- Understand that changes in resistance do not occur immediately. Set your desired resistance on the computer console and release the adjustment key. The computer will obey the command gradually.
- **NEVER** use your elliptical during an electrical storm. Surges may occur in your facility or household power supply that could damage elliptical components. Unplug the elliptical during an electrical storm as a precaution.
- Use caution while participating in other activities while pedaling on your elliptical, such as watching television, reading, etc. These distractions may result in serious injury.
- Always hold on to a handrail or hand bar while making control changes (resistance, etc.).
- Do not use excessive pressure on console control keys. They are precision set to function properly with little finger pressure. Pushing harder is not going to make the unit go faster or slower. If you feel the buttons are not functioning properly with normal pressure, contact your dealer.

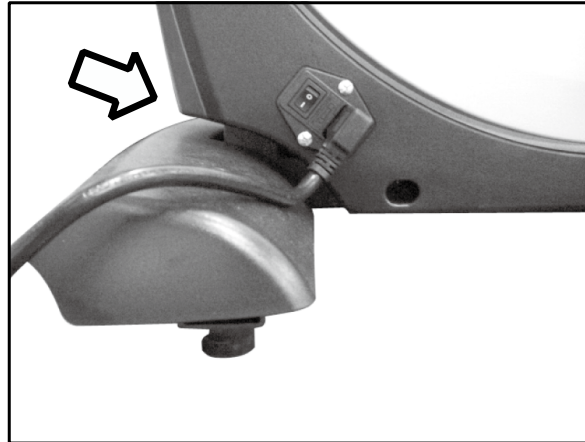

**POWER CONNECTOR - FRONT, LEFT SIDE OF UNIT**



# WARNING DECAL REPLACEMENT

The decal shown below has been placed on the bike. If the decal is missing or illegible, please call our Customer Service Department toll-free at 1-888-707-1880 to order a replacement decal.

**! WARNING / AVERTISSEMENT**

Model/Modèle#: [REDACTED]  
Serial#/Numéro de série: [REDACTED]

**For consumer use only.  
Max user weight limit**  
[REDACTED] (Max. 120 lbs)

CAUTION: SMALL CHILDREN AND PERSONS PHYSICALLY HANDICAPPED SHOULD NOT USE ANY EXERCISE EQUIPMENT WITHOUT A QUALIFIED PERSON IN ATTENDANCE. WARNING: KEEP CHILDREN AWAY FROM THE [REDACTED]. KEEP BODY AND CLOTHING FREE AND CLEAR OF ALL MOVING PARTS. THE POSSIBILITY OF SERIOUS INJURIES OR DEATH IF CAUTION IS NOT USED. READ ALL WARNINGS AND INSTRUCTIONS PRIOR TO USE. REPLACE LABEL IF DAMAGED, ILLEGIBLE OR REMOVED.

**Usage à des fins  
personnelles seulement  
poids maximum de l'utilisateur**  
[REDACTED] (Max. 120 lbs)

ATTENTION: LES ENFANTS ET LES PERSONNES AYANT UN HANDICAP PHYSIQUE NE DOIVENT UTILISER AUCUN APPAREIL D'EXERCICE SANS LA SURVEILLANCE D'UNE PERSONNE QUALIFIÉE. AVERTISSEMENT: GARDER LES ENFANTS À L'ÉCART DU [REDACTED]. GARDER LE CORPS ET LES VÊTEMENTS ÉLOIGNÉS DE TOUTE PIÈCE MOBILE. LE DÉFAUT DE VIGILANCE DANS L'UTILISATION DE CET APPAREIL POURRAIT ENTRAÎNER DE GRAVES BLESSURES ET MÊME LA MORT. LIRE TOUS LES AVERTISSEMENTS ET TOUTES LES DIRECTIVES AVANT UTILISATION. REMPLACER TOUTE ÉTIQUETTE ENDOMMAGÉE, ILLISIBLE OU MANQUANTE.

**Dyaco Canada Inc.  
5955 Don Murie St  
Niagara Falls, Ontario  
L2G 0A9**

**Customer Service  
Service à la clientèle  
1-888-707-1880**

# ASSEMBLY INSTRUCTIONS

## PRE-ASSEMBLY

1. Carefully remove all parts from the carton and inspect for any damage or missing parts. If damaged parts are found or parts are missing, contact your dealer immediately.
2. Locate the hardware package. The hardware is separated into four steps. Remove the tools first. Remove the hardware for each step as needed to avoid confusion. The numbers in the instructions that are in parenthesis (#) are the item number from the assembly drawing for reference.

## ASSEMBLY TOOLS

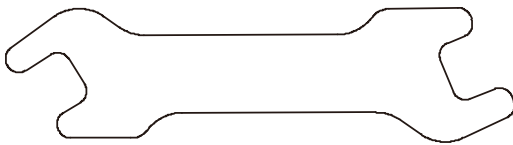

**#139.** 13/14mm  
Wrench (1 pc)

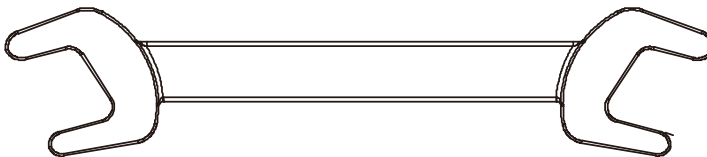

**#142.** 17 mm  
Wrench (1pc)

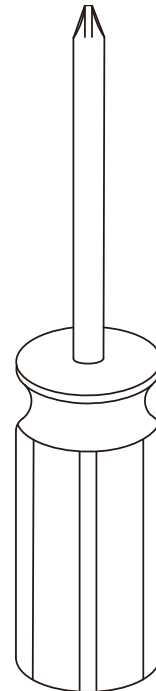

**#143.** Phillips Head  
Screw Driver (1 pc)

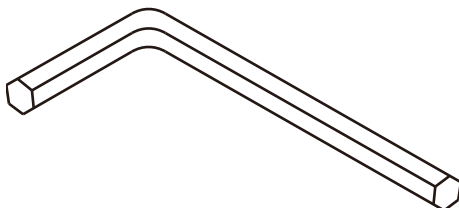

**#140.** L Allen Wrench (1 pc)

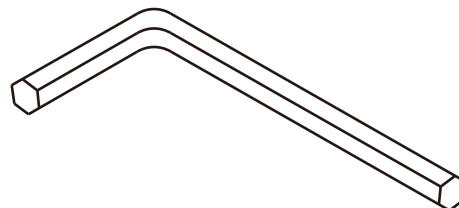

**#141.** M12\_L Allen Wrench (1 pc)

# ASSEMBLY PACK CHECKLIST

## STEP 1

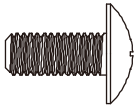

#97 - M5 x 12mm  
Phillips Head Screw (4 pcs)

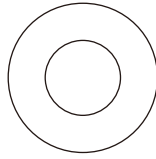

#130- 3/8" X19  
Flat Washer (4 pcs)



#129 - 3/8" X23  
Curved Washer (6 pcs)

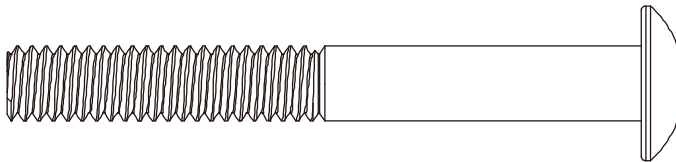

#128 - 3/8" x 3-3/4"  
Button Head Socket Bolt (6 pcs)

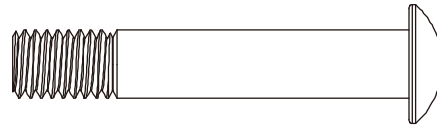

#127 - 3/8" x 2-1/4"  
Button Head Socket Bolt (4 pcs)

## STEP 2

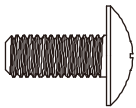

#97 - M5 x 12mm  
Phillips Head Screw (4 pcs)

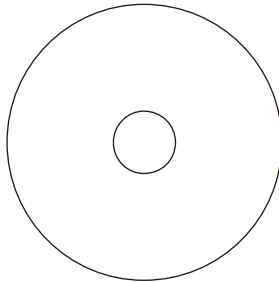

#106 - 5/16"  
Flat Washer (2 pcs)

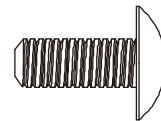

#119 - M6 x 15mm  
Phillips Head Screw (2 pcs)

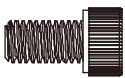

#126 - 5/16" x UNC18 x 15L  
Socket Head Cap Bolt (2 pcs)

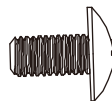

#131 - M5 x 10mm  
Phillips Head Screw (8 pcs)

### STEP 3

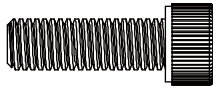

#132 - M8 x 25mm  
Socket Cap Bolt (4 pcs)

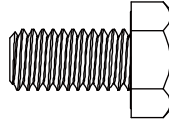

#135 - 3/8" x 3/4"  
Hex Head Bolt  
W / Loctite (2 pcs)

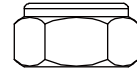

#136 - M10  
Nylon Nut (2 pcs)

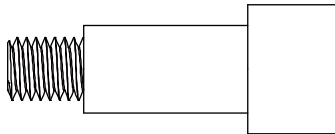

#137 - M10 x 1.5(14mm)  
Shoulder Bolt (2 pcs)

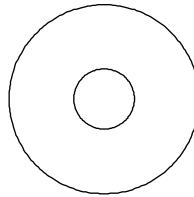

#138 - 3/8"  
Flat Washer (2 pcs)



#134 - 3.5mm x 12mm  
Sheet Metal Screw (4 pcs)



#133 - 25mm  
Wave Washer (2 pcs)

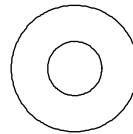

#107 - 5/16"  
Flat Washer (1 pcs)

### STEP 4



#134 - 3.5 x 12mm  
Sheet Metal Screw (14 pcs)

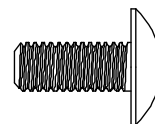

#97- M5 x 12mm  
Phillips Head Screw (16 pcs)

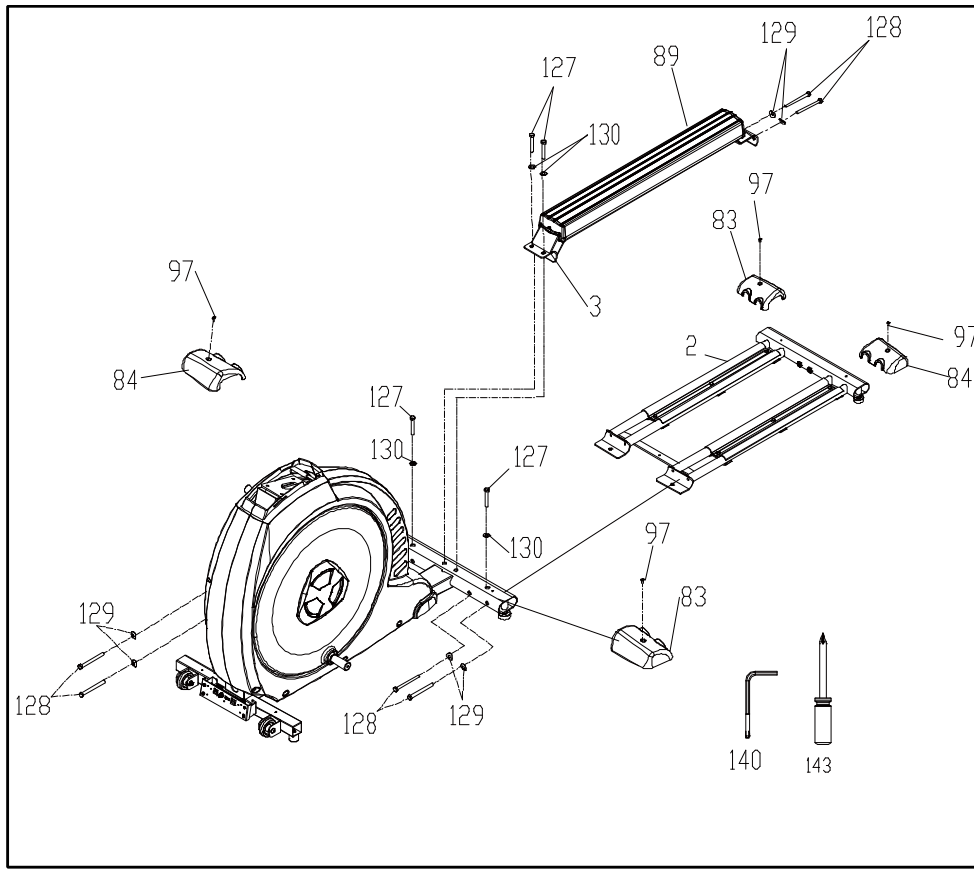

## STEP 1

1. Slide the Rear Rail Assembly (No.2) under the rear oval-shaped stabilizer tube on the Main Frame (No.1). From the top of the stabilizer, secure using 2 Button Head Socket Bolts (No. 127) and 2 Flat Washers (No. 130). From the side secure with 4 Button Head Bolts (No.128) and 4 Curved Washers (No.129).
2. Install the Rail Support Assembly (No.3) onto the Main Frame (No.1) and Rear Rail Assembly (No.2) using 2 Button Head Socket Bolts (No. 127) and 2 Flat Washers (No.130) on top. Use 2 Button Head Bolts (No.128) and 2 Curved Washers (No.129) at the rear.
3. Install the 4 Tube Stabilizer Covers (No. 2 83/84) using 4 Screws (No. 97).

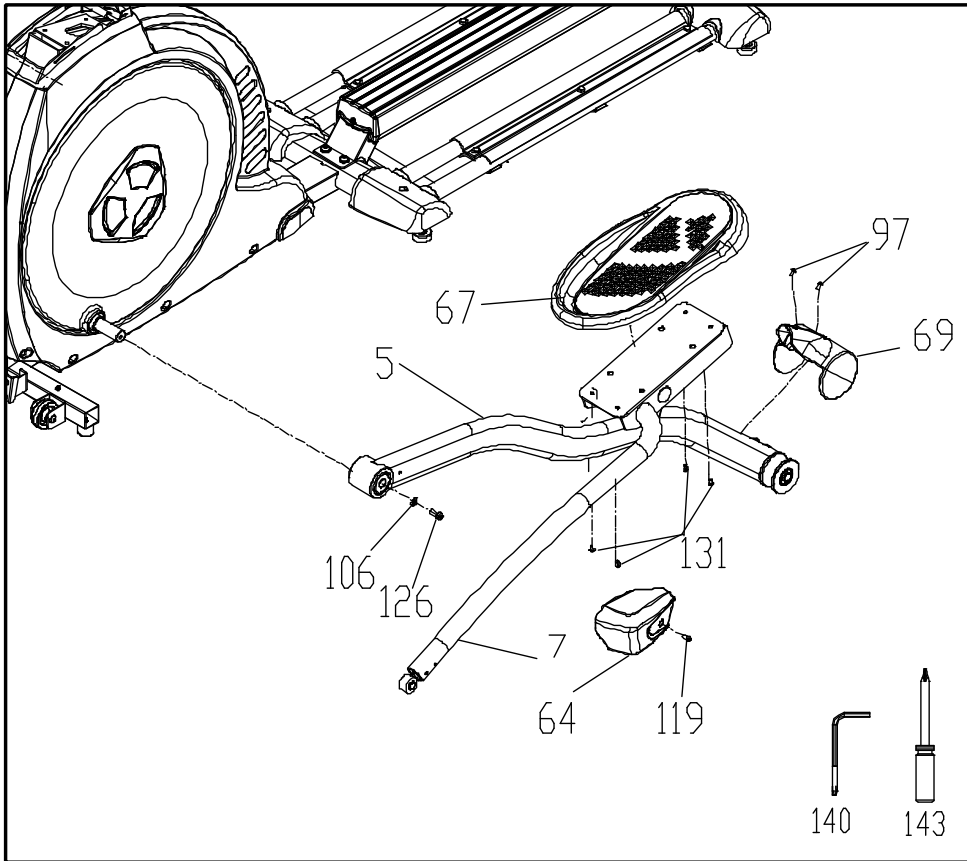

## STEP 2

1. Attach the Footplates (No. L 67) to the pedal mounting plate with 4 Screws (No.131).
2. Slide the Pedal Arm Assembly (No.5) onto the crank axle of the mainframe. Be careful not to force it because damage to the bearings can occur. Secure with a Bolt (126) and a Flat Washer (No.106).
3. Install the Cover (No.64) over the pedal arm connection at the rotation axle with a Screw (No.119).
4. Install the Roller Wheel Cover (No.69) with 2 Screws (No.97).
5. Repeat all steps with the opposite Pedal Arm Assembly (No.6).

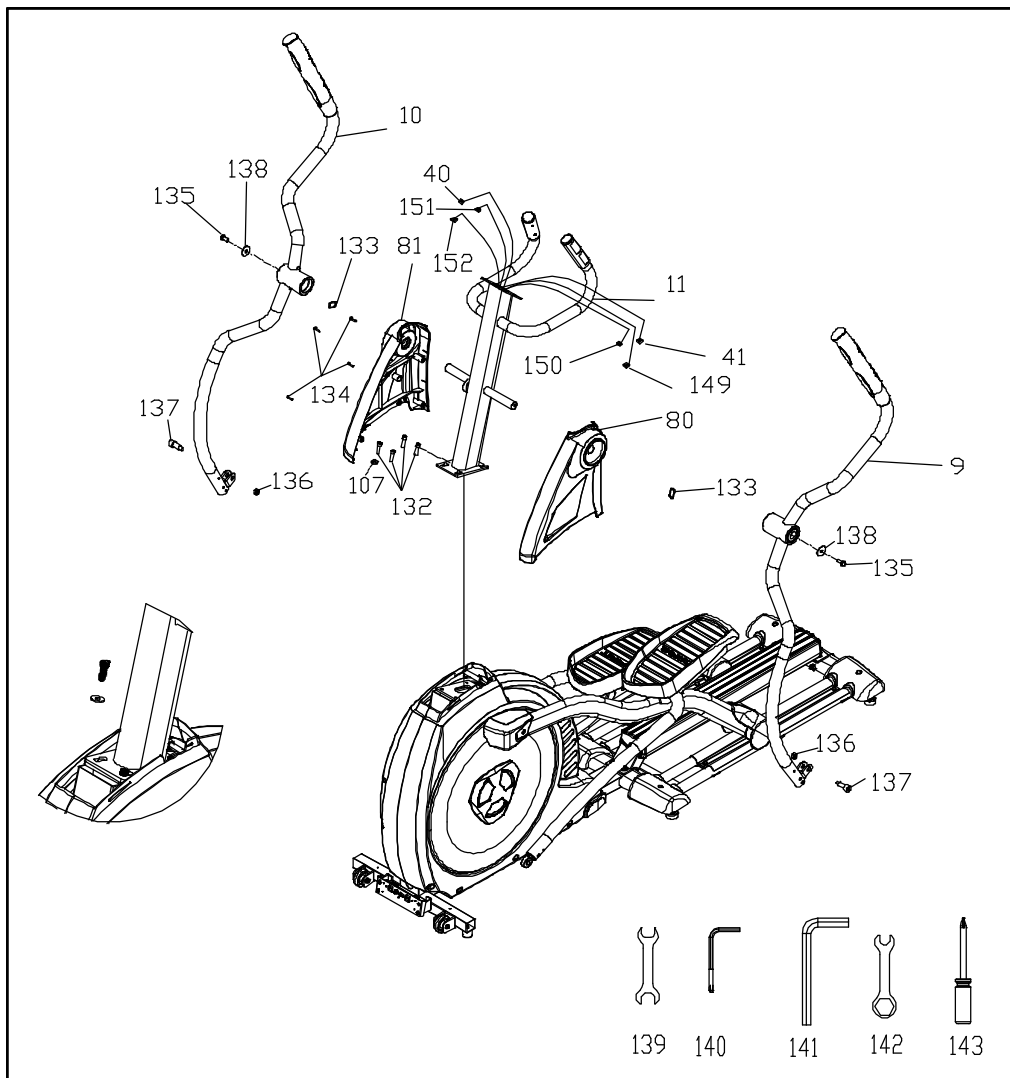

### STEP 3

1. Unravel the Computer Cable (No.152), CSAFE Connecting Wire (No.150), Communication Cable (No.149), HDMI Connecting Wire (No.151) and snake it through the bottom of the Console Mast (No.11) and out the top. To install the Mast Tube (No.11), first, insert 3 Socket Head Cap Bolts (No.132) onto the mainframe, then locate the Mast Tube (No.11) on its position and tighten three screws. Now the last Bolt (No.132) must be with Flat Washer (No.107) to tighten to the screw hole.
2. Mount the Console Mast Covers (No. L80/R81) with 4 Screws (No.134).
3. Install 2 Wave Washers (No.133) onto the console mast axle, then install the Swing Arms (L9)(R10) onto the axles. Do not force them or use a hammer as damage to the bearings can occur. Secure with a Bolt (No.135) and Washer (No.138) on each arm.
4. Attach the bottom of the swing arms to the rod ends of the pedal arms using 2 Shoulder Bolts (No.137) and 2 Nylon Nuts (No.136).

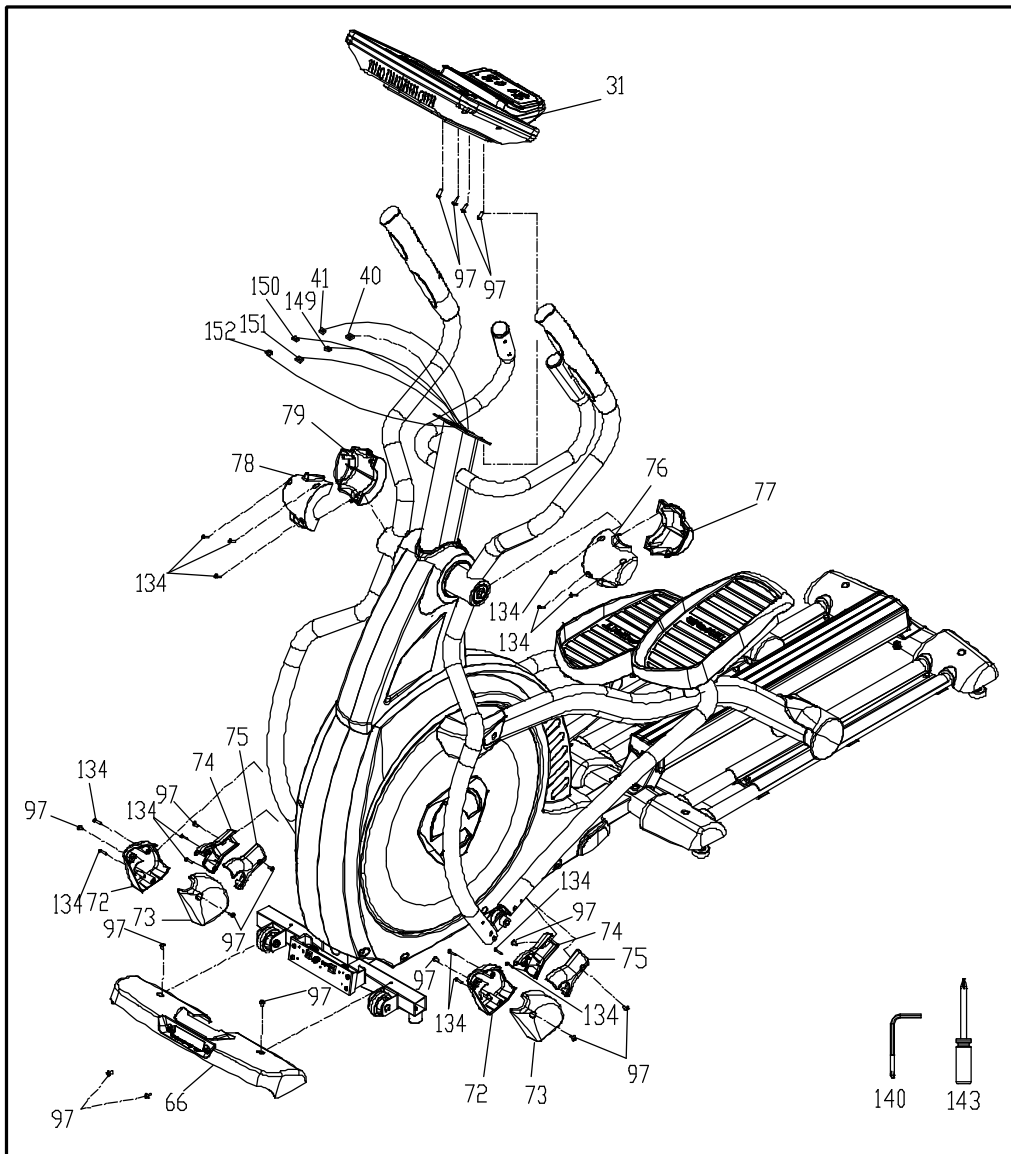

## STEP 4

1. Plug the Computer Cable (No.152), CSAFE Connecting Wire (No.150), Communication Cable (No.149), HDMI Connecting Wire (No.151), and Handpulse w/Cable Assembly (No.40/41) into the corresponding connectors on the back of the Console (No.31). Mount the Console (No. 30) to the Mast with 4 Screws (No.97).
2. Install 4 Swing Arm Covers (No. 77/76 left & 78/79 right) with 6 Screws (No.134).
3. Install 4 Covers (No. 74x2 & 75x2) to the ends of the Pedal Arms with 4 Screws (No.97) and 4 Screws (No.134). Be careful not to install these covers upside down! There is an arrow on the inside of each cover to indicate the correct installation direction.
4. Install the 4 Covers (No.72 x 2 & 73 x 2) to the connection point at the bottom of the swing arms using 4 Screws (No.134) and 4 Screws (97).
5. Install the Front Stabilizer Cover (No.66) with 4 Screws (No.97).



# OPERATION OF YOUR CONSOLE



## How to connect with Bluetooth

Click the Bluetooth icon to enter into the pairing page. The system will search for the available BT signal device around the elliptical. Then choose the device that you would like to connect with.



## CSAFE FEATURE

Your console is equipped with a CSAFE feature. The Power (POWER) port can be used for powering a remote-controlled audio-visual system by connecting a cable from the remote to the Power port at the back of the console. The Communication port (COMM) can be used to interact with fitness software applications.

## STARTING OPERATION

When the power is turned ON, the screen will show a brief loading screen and then display the Home Screen, which indicates that the machine is ready to operate.

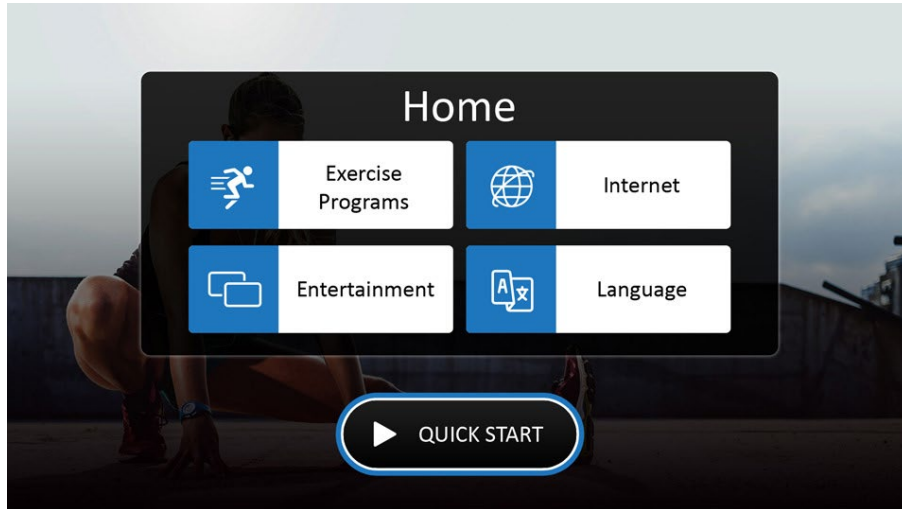

Home Screen: Begin operation by touching the icons.



Quick operating buttons are conveniently located for basic elliptical functions.

## **FUNCTIONS OF THIS ELLIPTICAL**

The Touchscreen is used for operating all functions. You can directly touch any button on the screen or through the physical buttons below the console to control functions. On the lower portion of the console, there is the Start button to begin the workout, the Stop button to pause/stop programs, Level button to change workload.

## **QUICK START**

This is the quickest way to start a workout. After the console powers up, you just press the Start button to begin. This will initiate the Quick Start mode. In Quick Start, the Time will count up from zero, all workout data will start to accrue, and the workload may be adjusted manually by pressing on the screen or the Up and Down buttons on the lower control panel.

## **HEART RATE FEATURE**

The Pulse (Heart Rate) on the screen shows the current value of the heartbeats per minute. You must use both left and right stainless steel sensors to pick up your pulse. Pulse values are displayed anytime the computer is receiving a signal from the hand pulse sensors. You may use the hand pulse sensors while in Heart Rate Control. The CE800ENT will also pick up wireless heart rate transmitters that are Polar and Bluetooth compatible.

## TOUCHSCREEN OPERATION

### LANGUAGE

There are 13 languages to choose from. Select your desired language by tapping it on the screen. Once selected, the system will return to the Home Screen with your new language being used. To return to the Home Screen without selecting a new language, press the Home button in the upper left corner of the screen.



### INTERNET

The Internet section offers various streaming, news, and social media options. The machine must be connected to the internet in order for the apps to work. Simply click on the app of your choice to connect. Follow any on-screen prompts to continue login or other authorizations as needed.

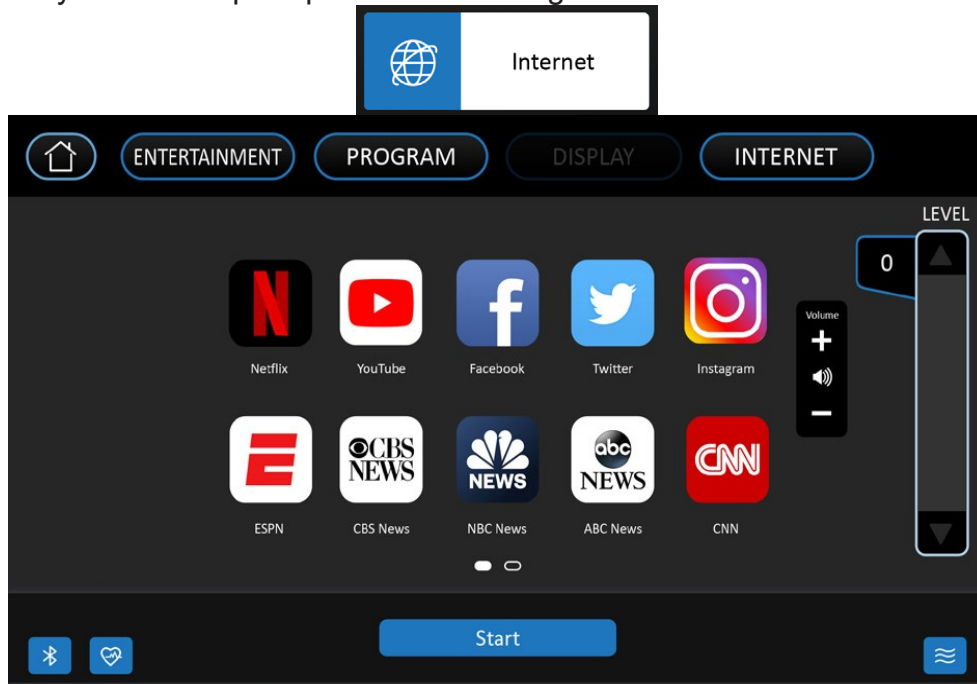

## ENTERTAINMENT OPTIONS

From the Home Screen, tap Entertainment to go to the entertainment menu. You will be given the options of Screen Mirroring and TV mode interface.

When properly connected to the Set-Top Box (STP) via the HDMI port and TV mode selected, you can enjoy TV programs after selecting TV mode from the Entertainment screen on your Elliptical.

### Once TV mode has begun:

- Use the ▲/▼ buttons on the right-hand side of the touchscreen to switch between channels.
- Use the +/- volume buttons on the right-hand side of the touchscreen to control the sound volume level.
- Tap the "□" button to display the media in full-screen mode. To resume to normal screen size, simply tap the "□" button again to minimize the screen view back to normal size.
- Use the on-screen or physical Resistance controls to make updates to your workout while in TV mode.
- To Pause, press the Stop button once.
- To end your workout, press the Stop button twice to show the workout summary. Pressing the Stop button a third time will return you to the Home Screen.

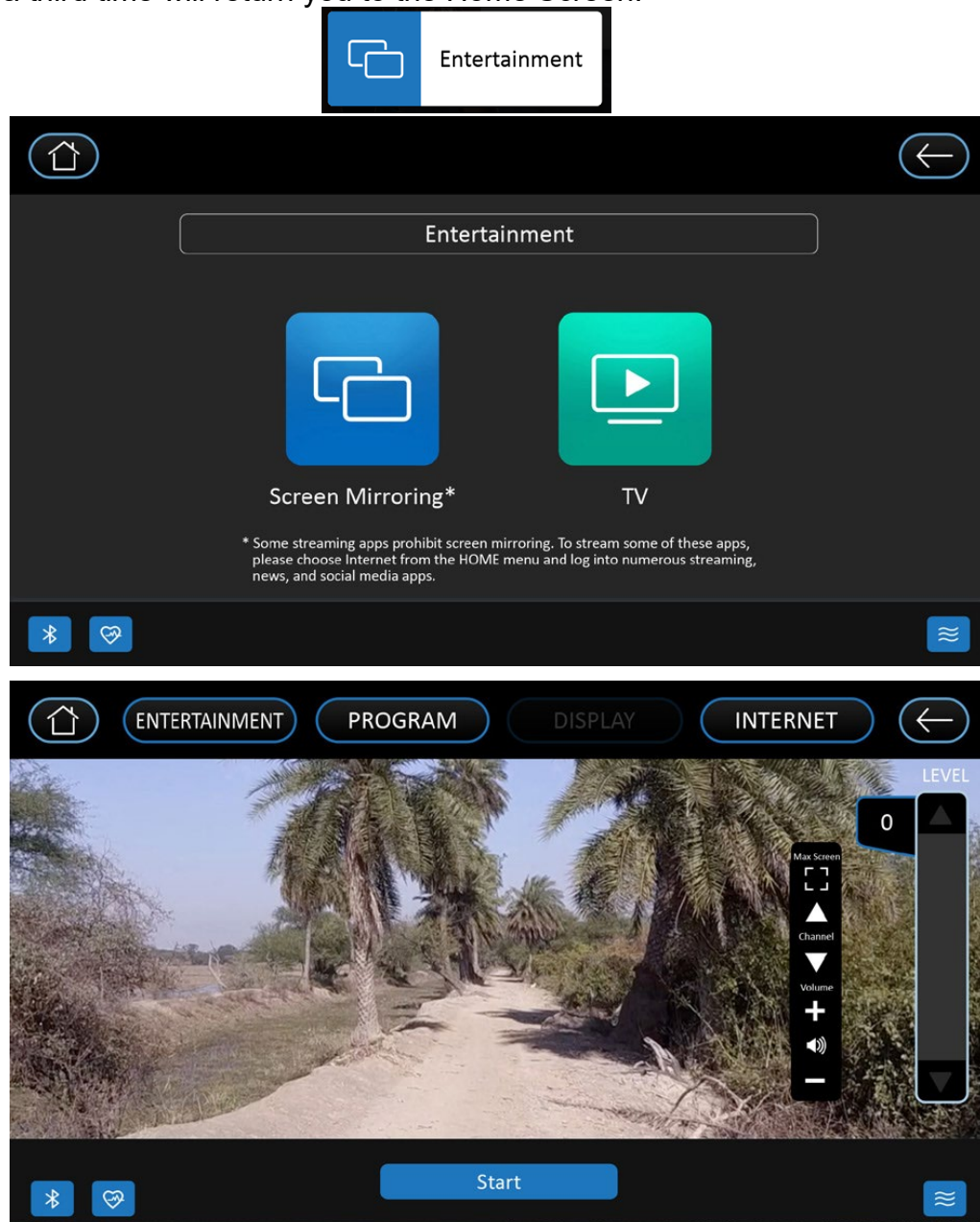

# SCREEN MIRRORING

When Screen Mirroring is selected from the Entertainment screen, you may begin pairing your device.

## iOS

Screen Mirroring displays your phone's screen on the touchscreen of the Elliptical. Please note that your device must be running iOS 8 or higher.

1. Connect your phone or tablet to the facility's WiFi.
2. Find and select the Screen Mirroring button on your phone or tablet by swiping up from your phone's main screen or by swiping down from the top left corner of the screen if you have a newer iOS installed. Note: When using an iOS device for Screen Mirroring, your Bluetooth headphones must be connected to the console.

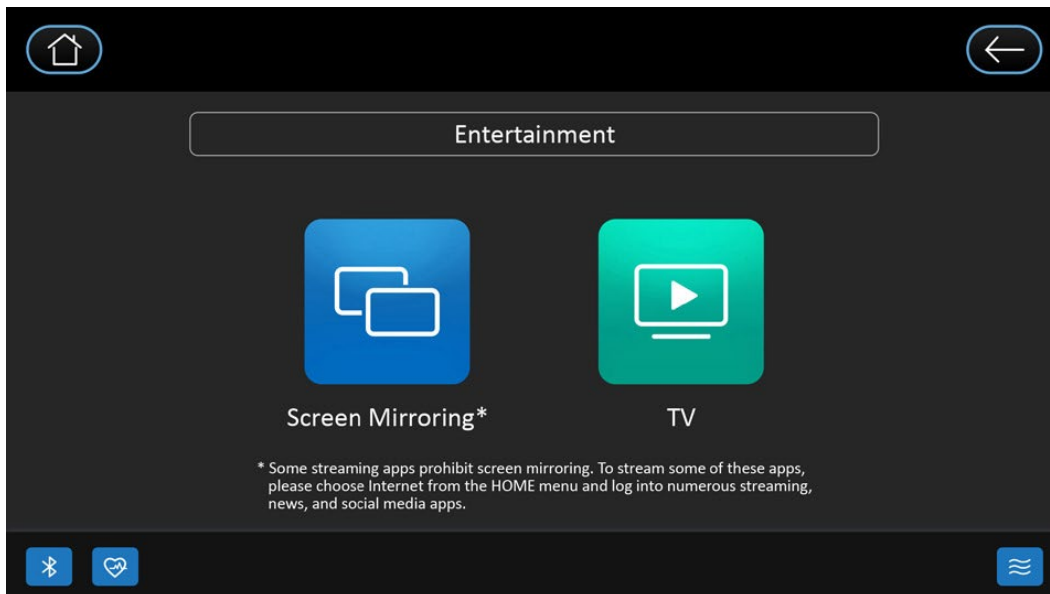

# SCREEN MIRRORING

## Android

1. Connect your phone or tablet to the facility's WiFi.
2. Scan the QR code or search for "Spirit Mirroring" in the Google Play store on your phone or tablet.
3. Download the app.
4. Open the Spirit Mirroring App and select the device name. Then, click Start Mirroring to complete the screen mirroring process. Note: When using an Android device for Screen Mirroring, your Bluetooth headphones must be connected to your device.



**Android Screen Mirroring Guide** 

**Step 1: Connect your phone or tablet to the facility's WiFi.**

**Step 2: Scan the QR code or search for "Spirit Mirroring" in the Google Play Store on your phone or tablet. Download the app.**

**Step 3: Open the Spirit Mirroring App. Select the device name "Spirit ENT-XXX," then click the "Start Mirroring" button to complete the screen mirroring process.**

Android - must connect your Bluetooth headphones to phone.

Wi-Fi Name: TP-LINK\_40CF  
Screen Mirroring must have a good Wi-Fi environment

Device Name : Spirit ENT-XXX

Min Screen  
Volume



## ENTERING A PROGRAM & CHANGING SETTINGS

When the Exercise Programs button is selected from the Home Screen, the screen displays a menu of the different programs available: Manual, Hill, Fat Burn, Cardio, HIIT, Interval, Heart Rate, Custom, Constant Power, and Fitness Test. To select and start a preset program:

1. Select a program by tapping it on the screen, then press Enter to begin. Customize the program on the following screens by entering your data, or press the Start button to begin the program using the default settings.
2. Press the Start button to begin your workout, or press the Stop button to return to the previous screen.

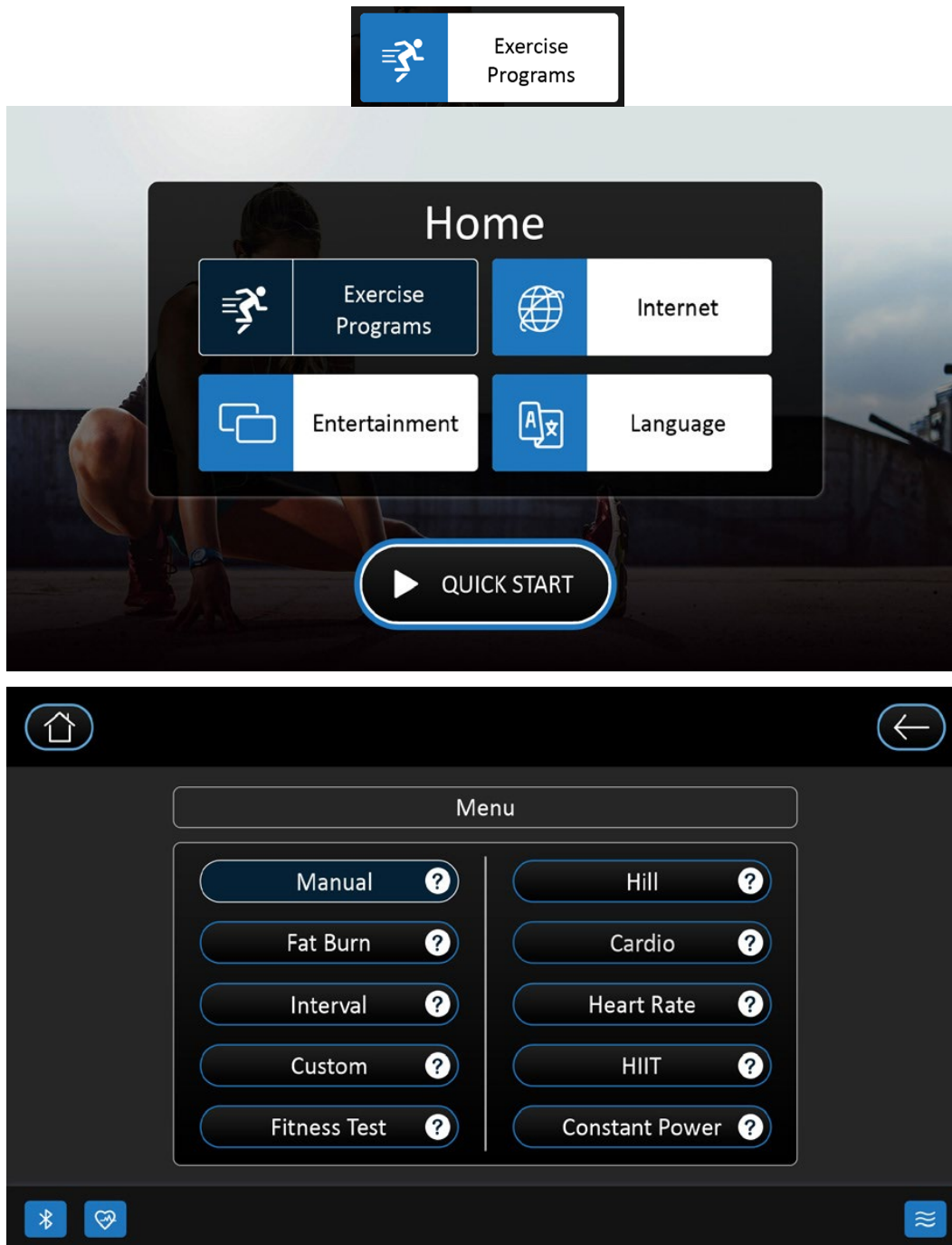



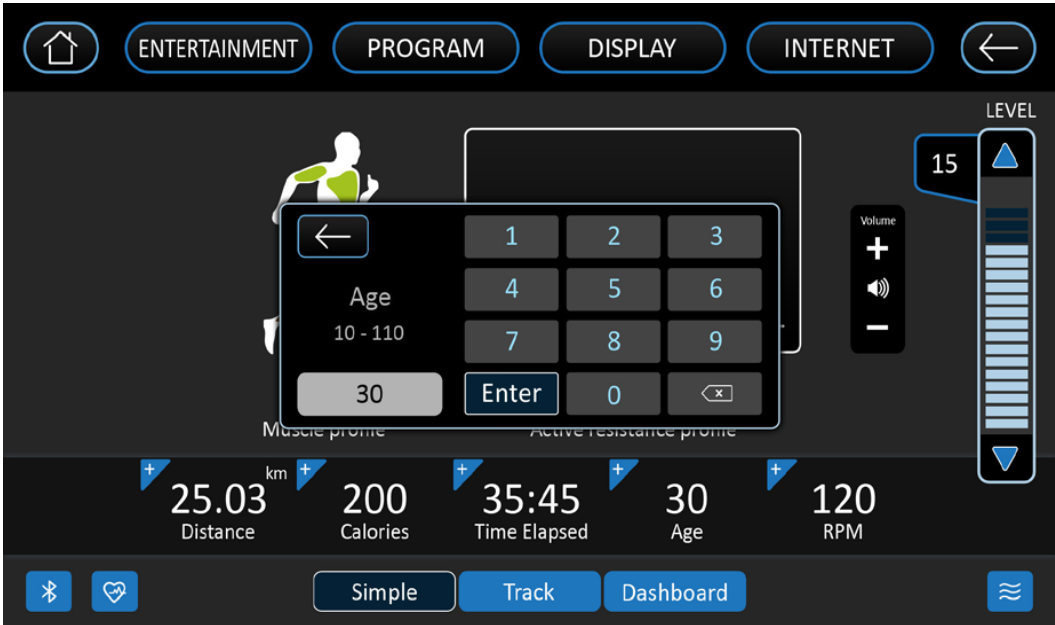
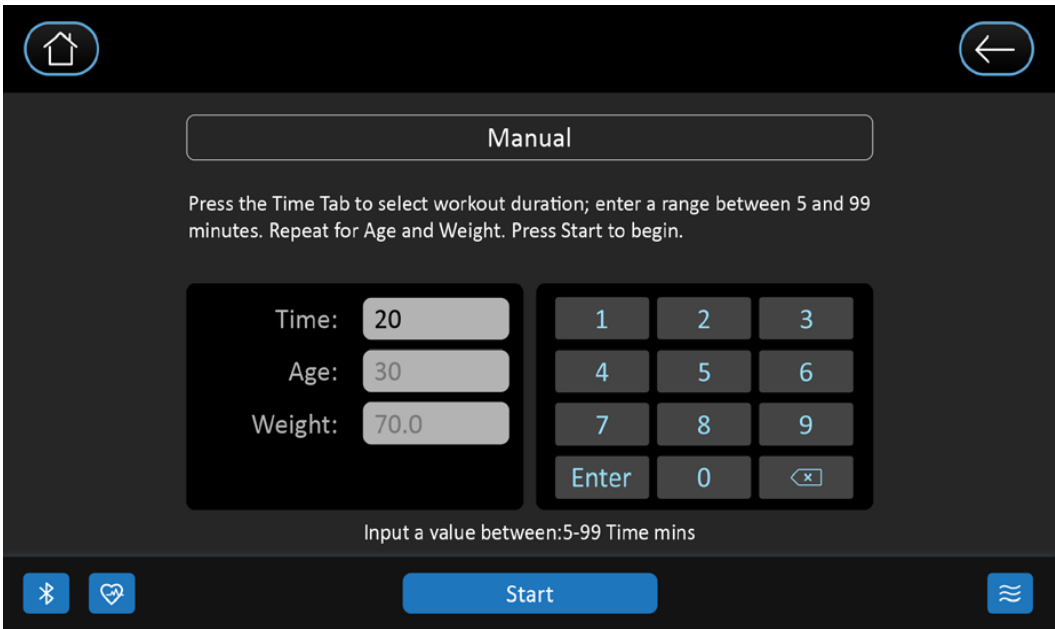

# EXERCISE PROGRAM

## CHANGING THE WORKOUT DISPLAY

During your workout, you may change the display based on the view that works best for your needs. Once your workout begins, you will see 3 preset views available at the bottom of the screen: Simple, Track, and Dashboard.

### SIMPLE

To switch the display to Simple view, simply tap the Simple button at the bottom of the screen. This view shows a muscle activation profile for the current workout, an overview of the Resistance profile, as well as the elapsed Distance, Calories/Hr, Total Time, Heart Rate, and RPM, as well as other exercise data.

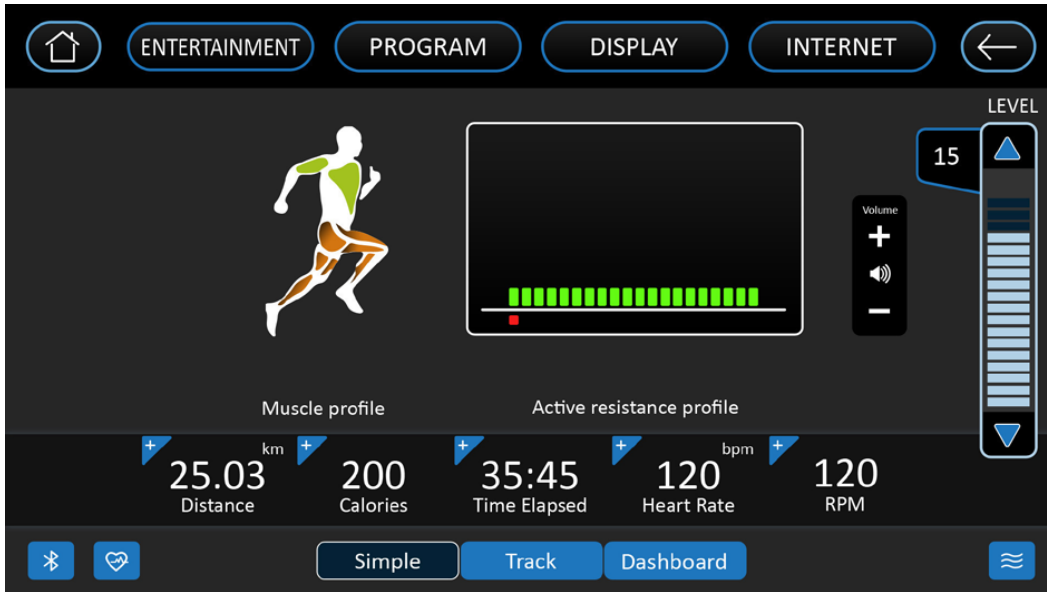

### TRACK

To switch the display to Track view, simply tap the Track button at the bottom of the screen. This view shows a virtual track that corresponds with the current workout, as well as the elapsed Distance, number of Laps, Calories, Total Time, Heart Rate, and RPM, as well as other exercise data.



# EXERCISE PROGRAM DASHBOARD

To switch the display to Dashboard view, simply tap the Dashboard button at the bottom of the screen. This view shows a virtual dashboard mimics a typical Elliptical display with information that corresponds with the current workout. Metrics such as elapsed Distance, Calories/Hr, Calories, Total Time, Heart Rate, and RPM are displayed as well as other exercise data.

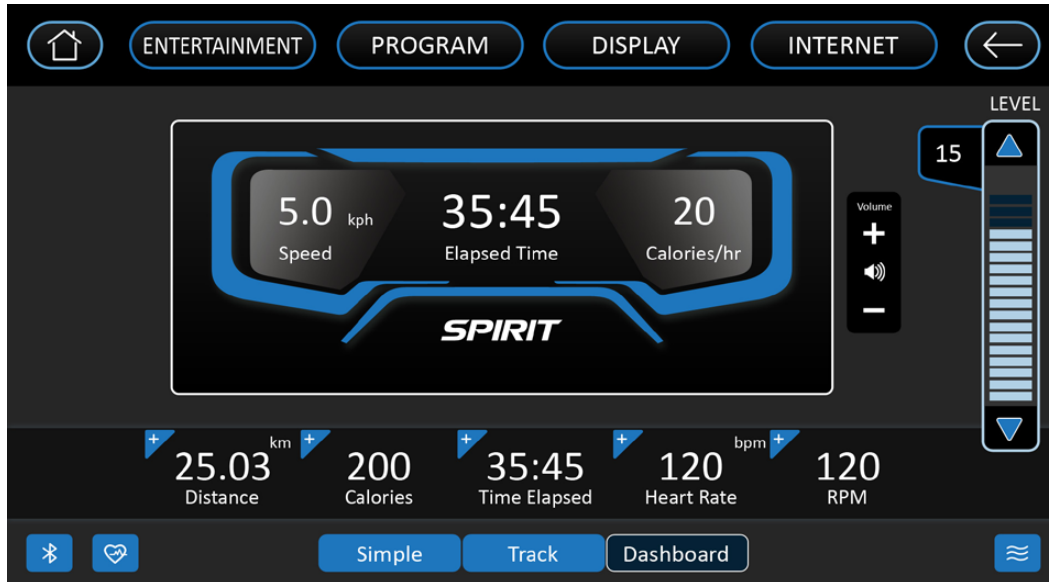

# MANUAL

The level of resistance is controlled by the user. Increase or decrease levels at any time during your workout.

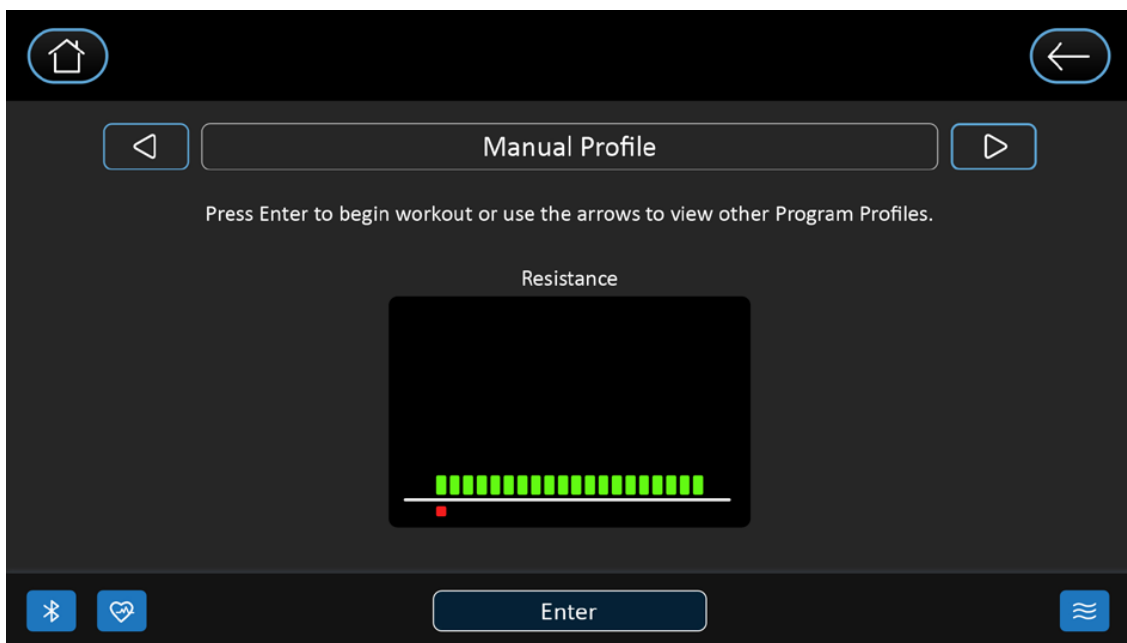
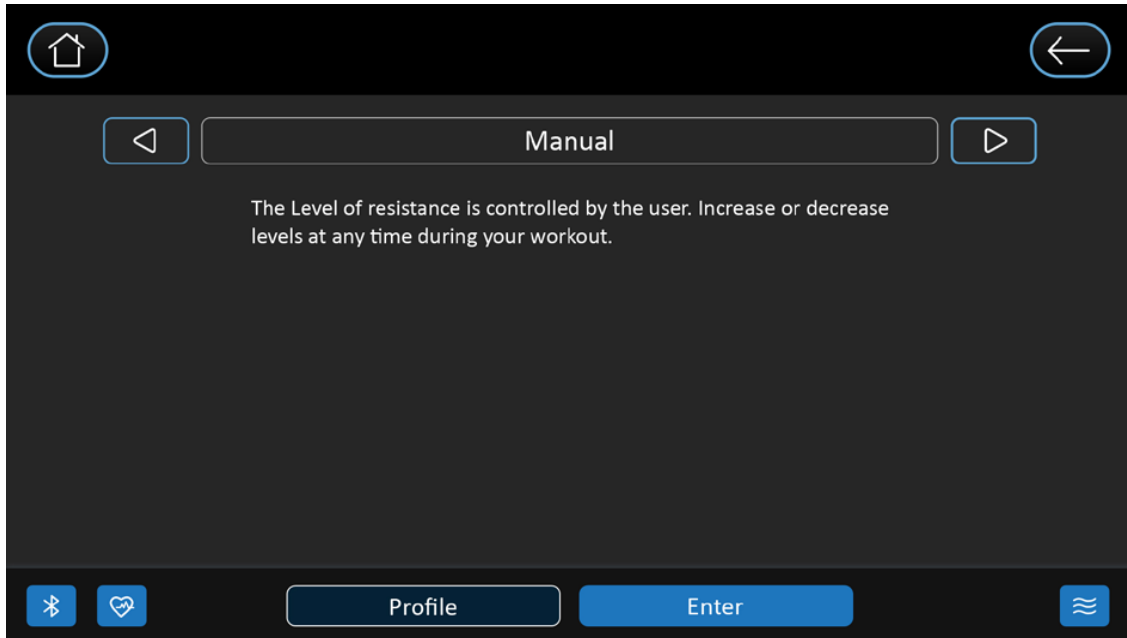

## HILL

This program follows a triangle or pyramid type of gradual progression from approximately 10% of maximum effort (the level that you chose before starting this program) up to a maximum effort which lasts for 10% of the total workout time, then a gradual regression of resistance back to approximately 10% of maximum effort.

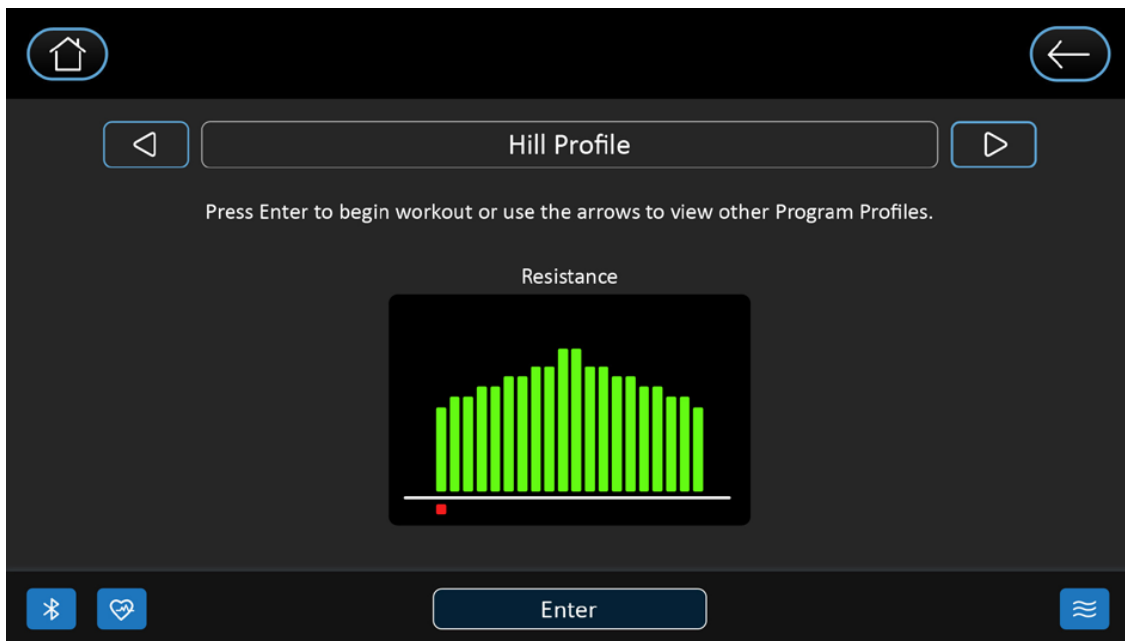

## FAT BURN

This program follows a quick progression up to the maximum resistance level (default or user input level) that is sustained for 2/3 of the workout. This program will challenge your ability to sustain your energy output for an extended period of time.

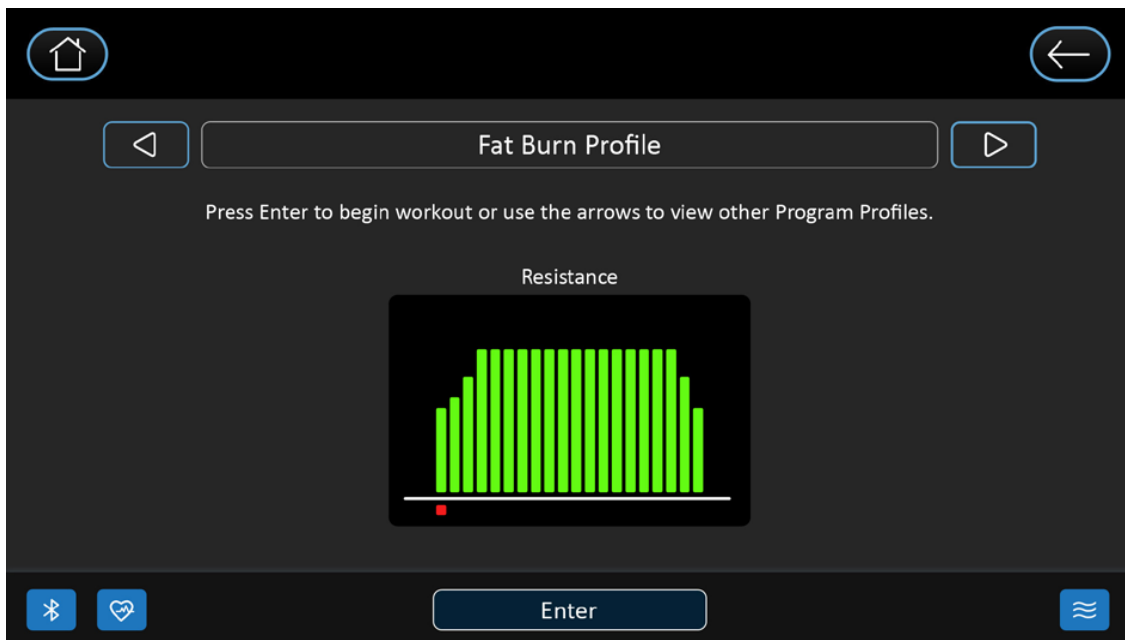

## CARDIO

This program presents a quick progression up to near maximum resistance level (default or user input level). It has slight fluctuations up and down to allow your heart rate to elevate and then recover repeatedly before beginning a quick cool down. This will build up your heart muscle and increase blood flow and lung capacity.

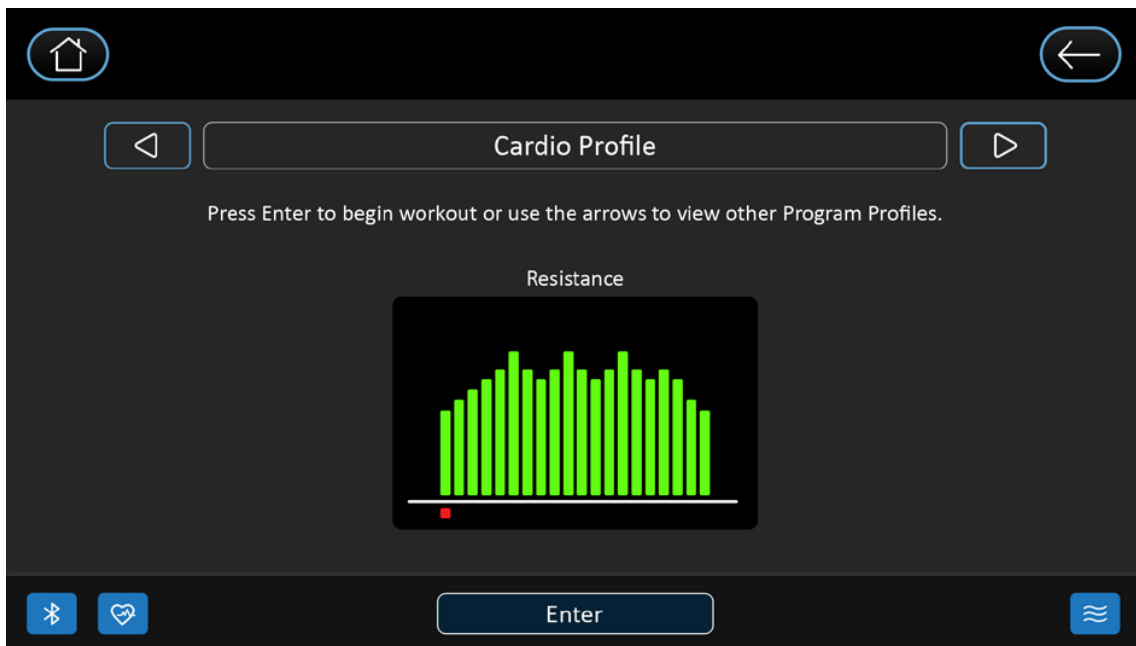

## INTERVAL

This program takes you through high levels of intensity, followed by recovery periods of low intensity. This program utilizes and develops your fast-twitch muscle fibres which are used when performing tasks that are intense and short in duration. These deplete your oxygen level and spike your heart rate, followed by periods of recovery and heart rate drop to replenish oxygen. Your cardiovascular system gets programmed to use oxygen more efficiently.

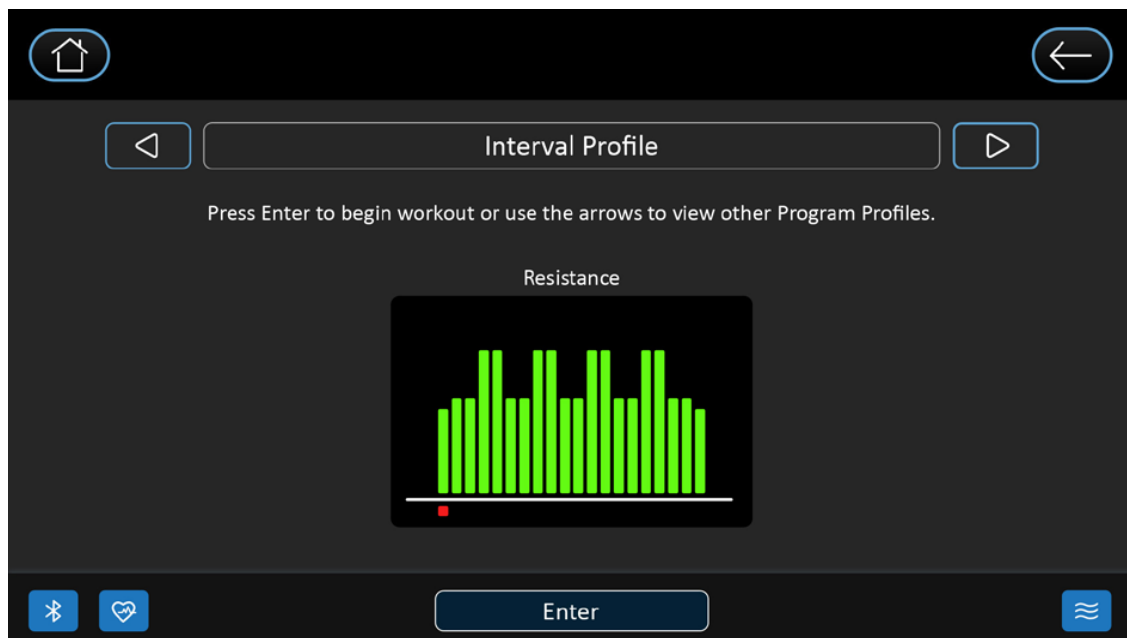

## CONSTANT POWER

A watts program is a controllable constant power whose level adjusts when the speed is changed. Choose either faster pedalling at a lower resistance level or slower pedalling at a higher resistance level.

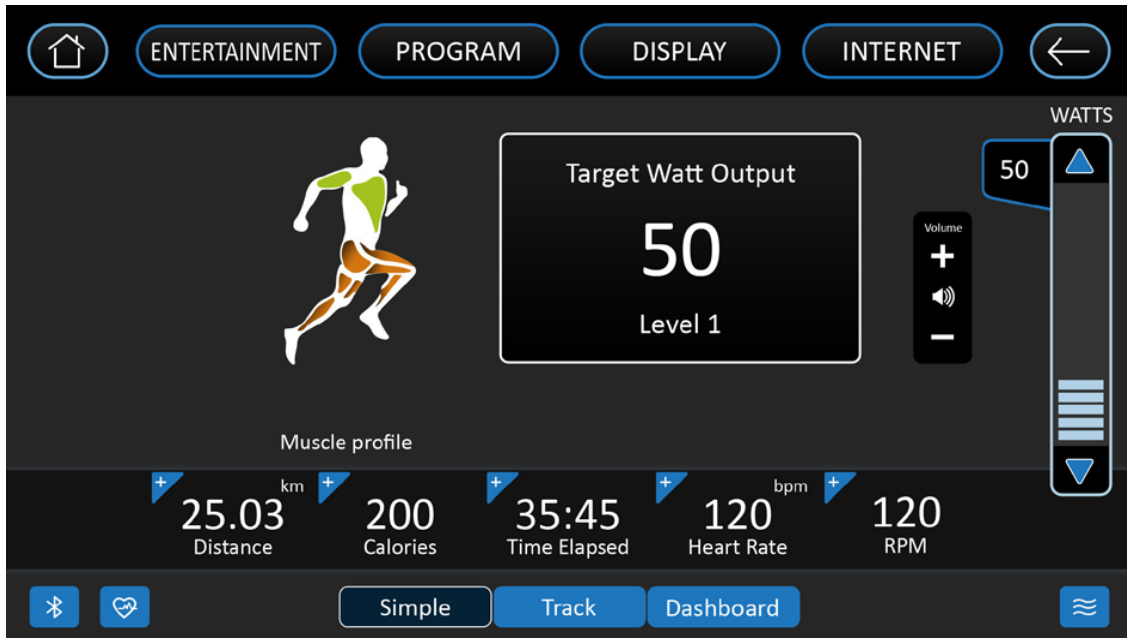

## HEART RATE

The default value is 65% of your projected rate maximum. You have the option of changing your target heart rate. The machine will attempt to keep you within five beats of your target heart rate.

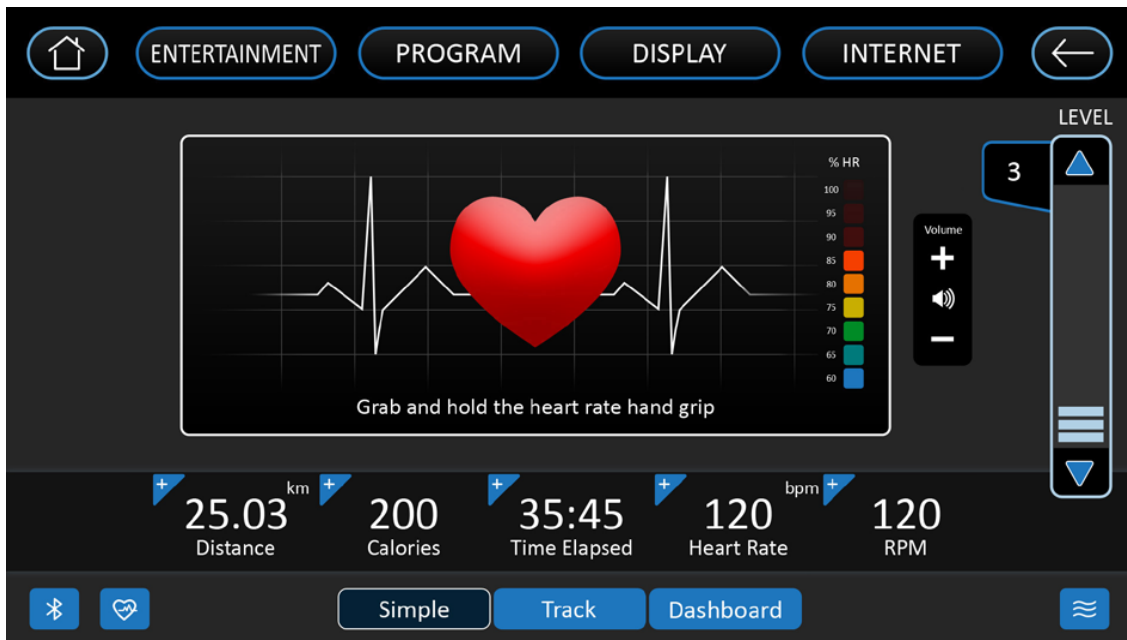

## CUSTOM

You will create the desired resistance levels for each of the 20 segments of the program using the keyboard on the screen. You may change these levels at any time during the workout.

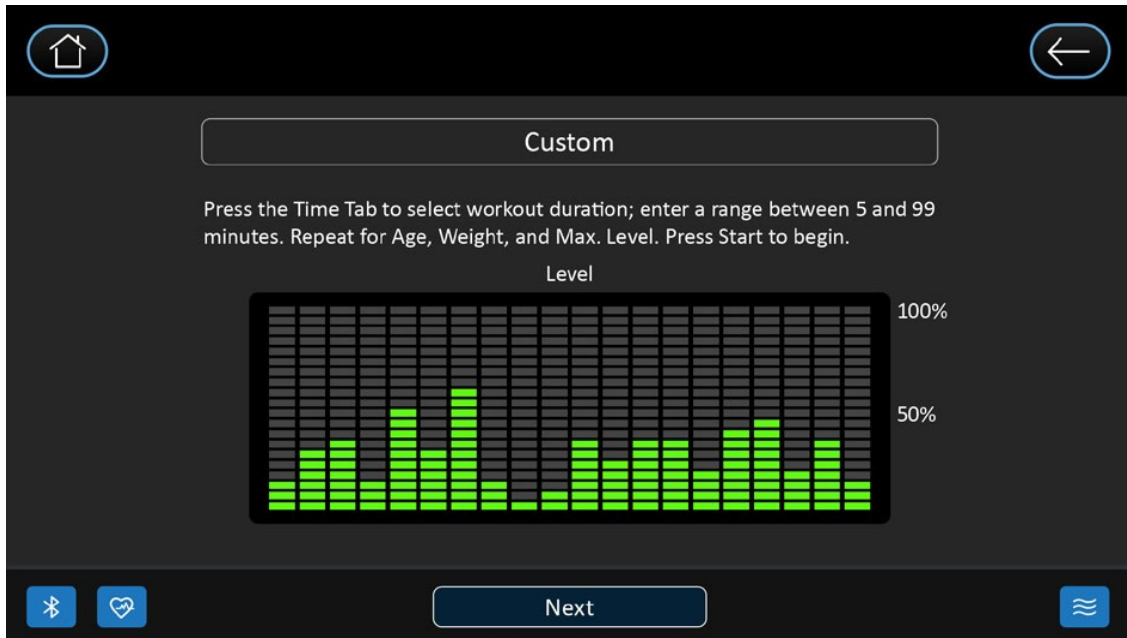

### TO BEGIN A CUSTOM PROGRAM:

1. Select the Custom program, then press the Enter key to begin customizing the program with your personal data, or just press the Start key to begin the program with the default settings.
2. The window will show the corresponding level profile, use the on-screen interface to achieve desired workout profiles. Once complete, press Next to save and continue.
3. The following screens will ask you to enter the desired Time, the user Age, and Weight. You may use the default values or adjust as needed. Press Start once complete to begin your new custom workout program!



## HIIT PROGRAM

The HIIT, or High-Intensity Interval Training program, takes advantage of the latest trend in fitness. During the program you will perform short bursts of high-intensity sprinting followed by short rest periods. HIIT is a fully customizable interval training program. You can enter the number of intervals, time of each interval Sprint and Rest periods and the work intensity of the levels.

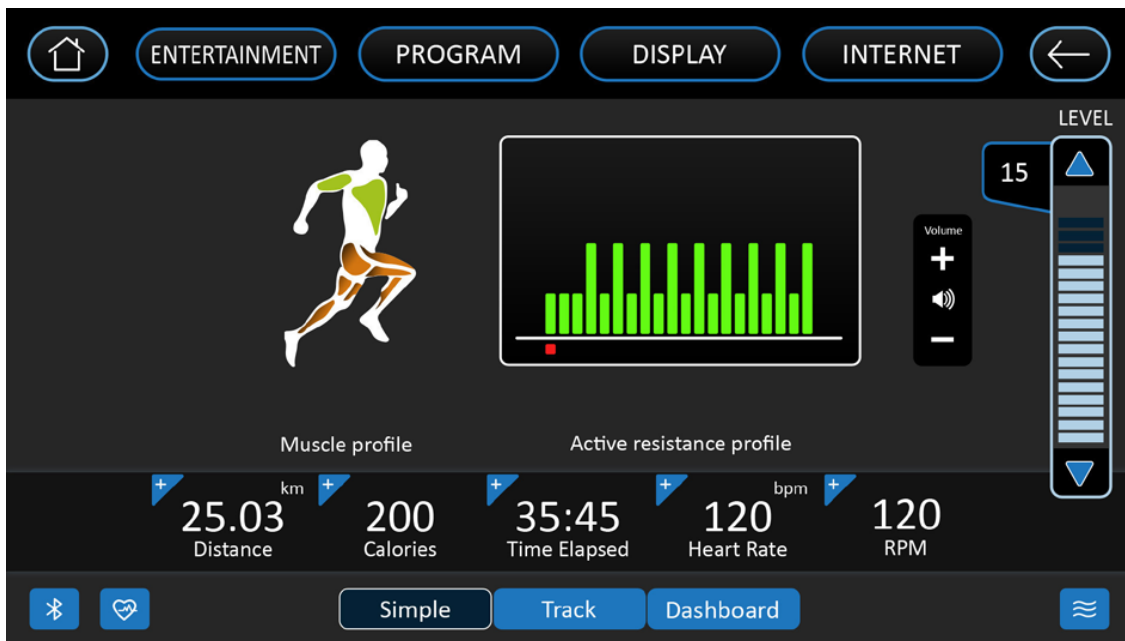

1. Select a program, then press the Enter key to begin customizing the program with your personal data, and you are asked for and the number of intervals you want to do. The default is 10, and the range available is 3 to 15. One interval equals 1 Sprint and 1 Rest segment.
2. Next is entering the Interval time, Sprint time and Rest time. You may select the Sprint time or Rest time from 20 to 90 seconds. After the interval time is set, set the intensity training to Sprint level and Rest level. This is the resistance level you will experience during the HIIT program workout.
3. You may now press Start to begin the HIIT program after adjusting the level. The program starts with a 3-minute warm-up period with the resistance level set to 50% of the sprint speed selected previously. You can manually adjust the resistance level during warm-up if you wish.

## FITNESS TEST

The VO2 program is based on the YMCA protocol and is a sub-maximal test that uses pre-determined, fixed work levels that are based on your heart rate readings as the test progresses. The test will take anywhere between 6 to 15 minutes to complete, depending on your level of fitness. The test ends when your heart rate reaches 85% of maximum at any time during the test, or your heart rate is between 110 bpm and 85% at the end of two consecutive stages. At the end of the test, a VO2max score will be given. VO2max stands for Volume of Oxygen uptake, which is a measurement of how much oxygen you need to perform a known amount of work. The YMCA protocol uses two to four 3 minute stages of continuous exercise (see charts below). You will be asked to choose either, Male or Female at the beginning of the test.

This choice determines which test parameters will be used during the test, as shown in the charts below.

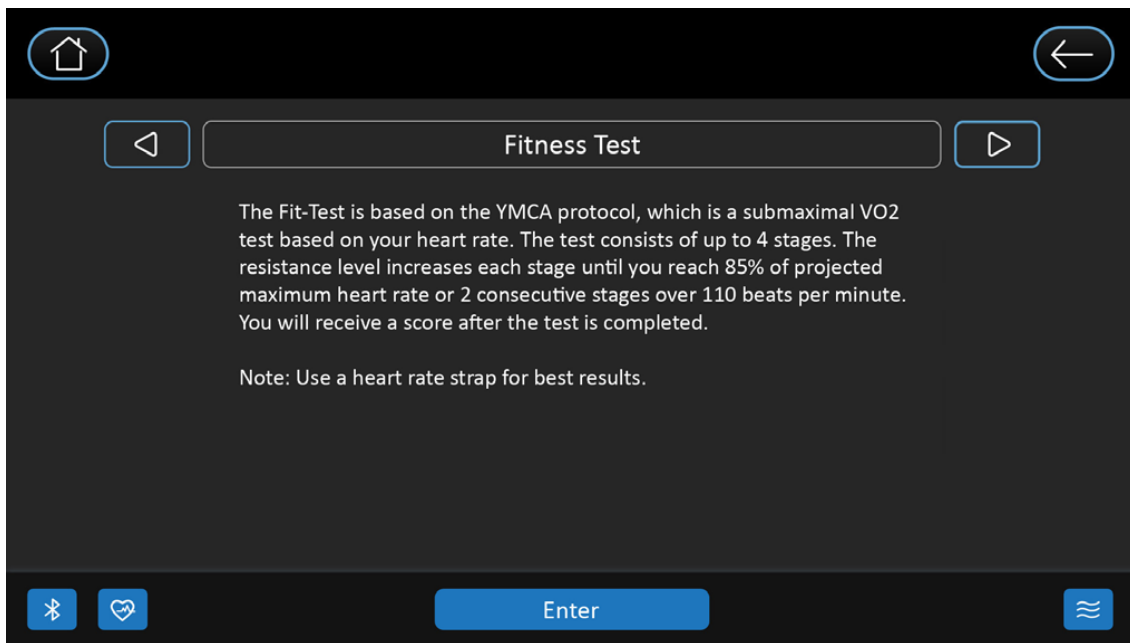

**Workload chart for male or very fit female:**

<b>1st Stage</b>				300 kgm/min					
<b>HR</b>		<b>&lt; 90</b>			<b>90 - 105</b>			<b>&gt; 105</b>	
<b>2nd Stage</b>		900 kgm/min			750 kgm/min			600 kgm/min	
<b>HR</b>	<b>HR &lt;120</b>	<b>HR 120-135</b>	<b>HR &gt;135</b>	<b>HR &lt;120</b>	<b>HR 120-135</b>	<b>HR &gt;135</b>	<b>HR &lt;120</b>	<b>HR 120-135</b>	<b>HR &gt;135</b>
<b>3rd stage</b>	1350 kgm/min	1200 kgm/min	1050 kgm/min	1200 kgm/min	- 1050 kgm/min	900 kgm/min	1050 kgm/min	900 kgm/min	750 kgm/min

**Workload chart for female or de-conditioned male**

<b>1st Stage</b>			150 kgm/min	
<b>Heart Rate</b>	<b>HR&lt;80</b>	<b>HR: 80-90</b>	<b>HR: 90-100</b>	<b>HR&gt;100</b>
<b>2nd Stage</b>	750 kgm/min	600 kgm/min	450 kgm/min	300 kgm/min
<b>3rd Stage</b>	900 kgm/min	750 kgm/min	600 kgm/min	450 kgm/min
<b>4th Stage (if needed)</b>	1050 kgm/min	900 kgm/min	700 kgm/min	600 kgm/min

## **Before the Test:**

- Make sure you are in good health; check with your physician before performing any exercise if you are over the age of 35 or persons with pre-existing health conditions.
- Make sure you have warmed up and stretched before taking the test.
- Do not take in caffeine before the test.
- Hold the handgrips gently, do not tense up.

## **During the Test**

- The console must be receiving a steady heart rate for the test to begin. You may use the hand pulse sensors or wear a heart rate chest strap transmitter.
- You must maintain a steady 50 rpm pedal speed. If your pedal speed drops below 48 rpm or goes above 52 rpm, the console will emit a steady beeping sound until you are within this range.
- You may scroll through the various data readings by pressing the Display button under the Message Window.
- The Message Window will always display your pedal speed on the right side to help you maintain 50 rpm.
- The data shown during the test is:
  1. Work in KGM is actually an abbreviated form of kg-m/min. which is a work measurement of kilogram-force meter/minute
  2. Work in Watts (1 watt is equal to 6.11829727787 kg-m/min.)
  3. HR is your actual heart rate; TGT is the target heart rate to reach to end of the test.
  4. Time is the total elapsed time of the test.

## **After The Test:**

- Cool down for about one to three minutes.
- Take note of your score because the console will automatically return to the start-up mode after a few minutes.

## What your score means:

### VO2max Chart for males and very fit females

	18-25 years old	26-35 years old	36-45 years old	46-55 years old	56-65 years old	65+ years old
excellent	>60	>56	>51	>45	>41	>37
good	52-60	49-56	43-51	39-45	36-41	33-37
above average	47-51	43-48	39-42	35-38	32-35	29-32
average	42-46	40-42	35-38	32-35	30-31	26-28
below average	37-41	35-39	31-34	29-31	26-29	22-25
poor	30-36	30-34	26-30	25-28	22-25	20-21
very poor	<30	<30	<26	<25	<22	<20

### VO2max Chart for females and de-conditioned males

	18-25 years old	26-35 years old	36-45 years old	46-55 years old	56-65 years old	65+ years old
excellent	56	52	45	40	37	32
good	47-56	45-52	38-45	34-40	32-37	28-32
above average	42-46	39-44	34-37	31-33	28-31	25-27
average	38-41	35-38	31-33	28-30	25-27	22-24
below average	33-37	31-34	27-30	25-27	22-24	19-22
poor	28-32	26-30	22-26	20-24	18-21	17-18
very poor	<28	<26	<22	<20	<18	<17

# HEART RATE PROGRAMS

The old motto, "no pain, no gain", is a myth that has been overpowered by the benefits of exercising comfortably. A great deal of this success has been promoted by the use of heart rate monitors. With the proper use of a heart rate monitor, many people find that their choice of exercise intensity is either too high or too low and exercise is much more enjoyable by maintaining their heart rate in the desired benefit range.

To determine the benefit range in which you wish to train, you must first determine your Maximum Heart Rate. This can be accomplished by using the following formula: 220 minus your age. This will give you the Maximum heart rate (MHR) for someone of your age. To determine the effective heart rate range for specific goals you simply calculate a percentage your MHR. Your Heart rate training zone is 50% to 90% of your maximum heart rate.

65% of your MHR is the zone that burns fat while 85% is for strengthening the cardio vascular system. This 65% to 85% is the zone to stay in for maximum benefit.

For someone who is 40 years old their target heart rate zone is calculated:

$$\begin{aligned} 220 - 40 &= 180 \text{ (maximum heart rate)} \\ 180 \times .65 &= 117 \text{ beats per minute (65\% of maximum)} \\ 180 \times .85 &= 153 \text{ beats per minute (85\% of maximum)} \end{aligned}$$

So for a 40 year old the training zone would be 117 to 153 beats per minute.

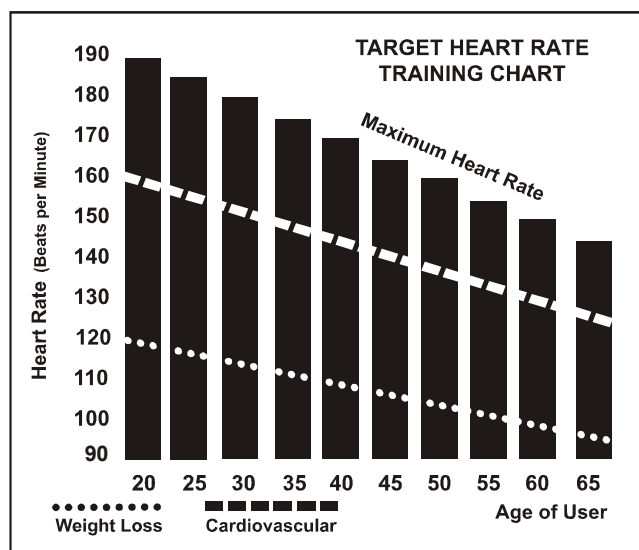

If you enter your age during programming the console will perform this calculation automatically. Entering your age is used for the Heart Rate control programs. After calculating your Maximum Heart Rate you can decide upon which goal you would like to pursue.

The two most popular reasons for, or goals, of exercise are cardiovascular fitness (training for the heart and lungs) and weight control. The black columns on the chart above represent the Maximum Heart Rate for a person whose age is listed at the bottom of each column. The training heart rate, for either cardiovascular fitness or weight loss, is represented by two different lines that cut diagonally through the chart. A definition of the lines' goal is in the bottom left-hand corner of the chart. If your goal is cardiovascular fitness or if it is weight loss, it can be achieved by training at 85% or 65%, respectively, of your Maximum Heart Rate on a schedule approved by your physician. Consult your physician before participating in any exercise program.

With all Heart Rate Control elliptical equipment, you may use the heart rate monitor feature without using the Heart Rate Control program. However, when using the heart rate monitor feature in conjunction with the Heart Rate programs, the machine will automatically adjust speed or incline to maintain the desired heart rate.

## CAUTION!

The target value used in HR programs is a suggestion only for normal, healthy individuals. Do not exceed your limits! You may not be able to obtain your chosen target. If in question, enter a higher age value that will set a lower target goal.

# RATE OF PERCEIVED EXERTION

Heart rate is important but listening to your body also has a lot of advantages. There are more variables involved in how hard you should work out than just heart rate. Your stress level, physical health, emotional health, temperature, humidity, the time of day, the last time you ate and what you ate all contribute to the intensity at which you should workout. If you listen to your body, it will tell you all of these things.

The rate of perceived exertion (RPE), also known as the Borg scale, was developed by Swedish physiologist G.A.V. Borg. This scale rates exercise intensity from 6 to 20 depending upon how you feel or the perception of your effort.

The scale is as follows:

## Rating Perception of Effort

- 6 Minimal
- 7 Very, very light
- 8 Very, very light +
- 9 Very light
- 10 Very light +
- 11 Fairly light
- 12 Comfortable
- 13 Somewhat hard
- 14 Somewhat hard +
- 15 Hard
- 16 Hard +
- 17 Very hard
- 18 Very hard +
- 19 Very, very hard
- 20 Maximal

You can get an approximate heart rate level for each rating by simply adding a zero to each rating. For example, a rating of 12 will result in an approximate heart rate of 120 beats per minute. Your RPE will vary depending on the factors discussed earlier. That is the major benefit of this type of training. If your body is strong and rested, you will feel strong, and your pace will feel easier. When your body is in this condition, you are able to train harder, and the RPE will support this. If you are feeling tired and sluggish, it is because your body needs a break. In this condition, your pace will feel harder. Again, this will show up in your RPE, and you will train at the proper level for that day.

# USING HEART RATE TRANSMITTER (Optional)

How to wear your wireless chest strap transmitter:

1. Attach the transmitter to the elastic strap using the locking parts.
2. Adjust the strap as tightly as possible as long as the strap is not too tight to remain comfortable.
3. Position the transmitter centred in the middle of your body facing away from your chest (some people must position the transmitter slightly left of center). Attach the final end of the elastic strap by inserting the round end and, using the locking parts, secure the transmitter and strap around your chest.
4. Position the transmitter immediately below the pectoral muscles.
5. Sweat is the best conductor to measure very minute heartbeat electrical signals. However, plain water can also be used to pre-wet the electrodes (2 black square areas on the reverse side of the belt and either side of the transmitter). It's also recommended that you wear the transmitter strap a few minutes before your workout. Some users, because of body chemistry, have a more difficult time achieving a strong, steady signal at the beginning. After "warming up," this problem lessens. As noted, wearing clothing over the transmitter/strap doesn't affect performance.
6. Your workout must be within range - the distance between transmitter/receiver – to achieve a strong, steady signal. The length of the range may vary somewhat but generally stay close enough to the console to maintain good, strong, reliable readings. Wearing the transmitter immediately against bare skin assures you of proper operation. If you wish, you may wear the transmitter over a shirt. To do so, moisten the areas of the shirt that the electrodes will rest upon.



*Note: The transmitter is automatically activated when it detects activity from the user's heart. Additionally, it automatically deactivates when it does not receive any activity. Although the transmitter is water-resistant, moisture can have the effect of creating false signals, so you should take precautions to completely dry the transmitter after use to prolong battery life (estimated transmitter battery life is 2500 hours). If your chest strap has a replaceable battery, the replacement battery is Panasonic CR2032.*

## ERRATIC OPERATION

Caution! Do not use this elliptical for Heart Rate programs unless a steady, solid Actual Heart Rate value is being displayed. High, wild, random numbers being displayed indicate a problem.

Areas to look for interference which may cause erratic heart rate:

1. Elliptical is not properly grounded.
2. Microwave ovens, TV's, small appliances, etc.
3. Fluorescent lights.
4. Some household security systems.
5. Electric fence for a pet.
6. Some people have problems with the transmitter picking up a signal from their skin. If you have problems try wearing the transmitter upside down.
7. The antenna that picks up your heart rate is very sensitive. If there is an outside noise source, turning the whole machine 90 degrees may de-tune the interference.
8. Another Individual wearing a transmitter within 3' of your machine's console.

**If you continue to experience problems contact your dealer.**



# GENERAL MAINTENANCE

1. Wipe down all areas in the sweat path with a damp cloth after each workout.
2. If a squeak, thump, clicking, or rough feeling develops, the main cause is most likely one of two reasons:
  - a. The hardware was not sufficiently tightened during assembly. All bolts that were installed during assembly need to be tightened as much as possible. It may be necessary to use a larger wrench than the one provided if you cannot tighten the bolts sufficiently. I cannot stress this point enough; 90% of calls to the service department for noise issues can be traced to loose hardware.
  - b. The crank arm nut needs to be retightened. If squeaks or other noises persist, check that the unit is properly levelled. There are 2 levelling pads on the bottom of the rear stabilizer. Use a 14mm wrench (or an adjustable wrench) to adjust the levelers.

## WARNING

The effect that the safety level of the equipment can be maintained only if it is examined regularly for damage and wear.

- i. Replace defective components immediately and/or keep the equipment out of use until repair.
- ii. The components which are most susceptible to wear: Belt ∙ PU wheel ∙ Bearing ∙ Idler.

# EXPLODED VIEW DIAGRAM

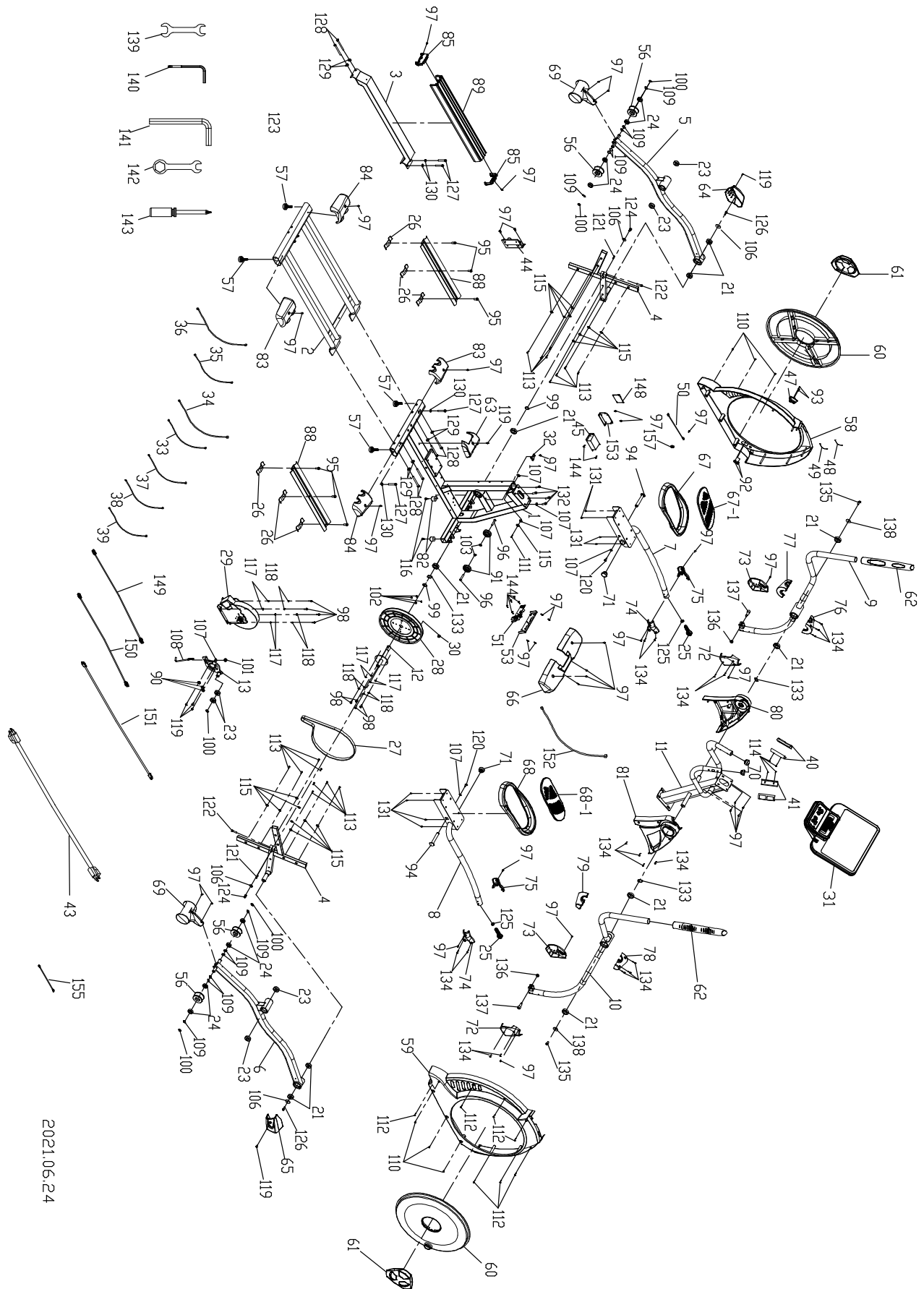

2021.06.24

# PARTS LIST

KEY NO.	PART NO.	DESCRIPTION	Q'TY
1	BB010104-S13	Main Frame	1
2	RBB030051-S13	Rear Rail Assembly	1
3	BB070058-S13	Rail Support Assembly	1
4	RBB040006-S13	Cross Bar	2
5	RBB050072-S13	Pedal Arm (L)	1
6	RBB050073-S13	Pedal Arm (R)	1
7	RBB050074-S13-03	Connecting Arm (L)	1
8	RBB050075-S13-03	Connecting Arm (R)	1
9	RBB060175-S13	Swing Arm (L)	1
10	RBB060176-S13	Swing Arm (R)	1
11	RBB020127-S13	Console Mast	1
12	RC140009A	Crank Axle	1
13	RB140043-S13	Idler Wheel Assembly	1
21	K056005-A2	6005_Bearing	10
23	K056203-A2	6203_Bearing	6
24	K056003-A2	6003_Bearing	8
25	K050007	M14 × P2.0_Rod End Bearing	2
26	B132400-S13	Retaining Bracket, Aluminum Track	6
27	N010002	Drive Belt	1
28	PP060090-A1-B	Drive Pulley	1
29	K500054	Flywheel	1
30	N040002	Magnet	1
31	RZEYE0360-21	Console Assembly	1
32	E011211	500mm_Sensor W/Cable	1
33	E010463	300mm_Wire Brake Coil Harness(Red)	1
34	E010462	600mm_Connecting Wire(Black)	1
35	E022605	600mm_Connecting Wire(White)	1
36	E010331-01	700mm_Computer Cable	1
37	E010330-01	150mm_Connecting Wire(Black)	1
38	E011510	150mm_Connecting Wire(White)	1
39	F090204-01	150mm_Connecting Wire, Power Cord	1
40	F090204-02	850mm_Handpulse W/Cable Assembly(XHP-3)	1
41	E060001	850mm_Handpulse W/Cable Assembly(XHP-4)	1
43	F030439	Power Cord	1
44	D020628	EMS Controller	1
45	D024802	Power Adaptor	1
47	F030071	AC Electronic Module	1
48	E010083	80mm_Connecting Wire (White)	1
49	E010084	80mm_Connecting Wire (Black)	1
50	E040007-01	200mm_Ground Wire	1
51	D020629	board	1
53	B110034-Z3	Transfer board	1
56	RP050030B	Ø72_Slide Wheel , Urethane	4
57	N270027	Ø35 × 10mm_Rubber Foot	4
58	RPP060075B-I1-01	Chain Cover (L)	1
59	RPP060076-I1-03	Chain Cover (R)	1

KEY NO.	PART NO.	DESCRIPTION	Q'TY
60	RP060077-I1	Round Disk	2
61	PP110014-I1	Round Disk Cover	2
62	P210009-A1	TPR Handle Bar Axle Inner Cover	2
63	P190017-I1	Beam Cover	1
64	P180042-I1	Pedal Arm Cover (L)	1
65	P180043-I1	Pedal Arm Cover (R)	1
66	P190047-I1	Front Stabilizer Cover	1
67	PP130015A-A1	Pedal (L)	1
67-1	P120026-A1	Pedal Foam (R)	1
68	PP130016A-A1	Pedal (R)	1
68-1	P120025-A1	Pedal Foam (L)	1
69	P060162-I1	Slide Wheel Cover	2
70	P060253-A1	Ø32(1.8T) Button Head Plug	2
71	P040035-A1	Pedal End Cover	2
72	P180001-I1	Connecting Arm Cover A (R)	2
73	P180002-I1	Connecting Arm Cover A (L)	2
74	P180003-I1	Connecting Arm Cover B (R)	2
75	P180004-I1	Connecting Arm Cover B (L)	2
76	P180046-I1	Front Handle Bar Cover (L)	1
77	P180047-I1	Rear Handle Bar Cover (L)	1
78	P180048-I1	Front Handle Bar Cover (R)	1
79	P180049-I1	Rear Handle Bar Cover (R)	1
80	PP100050-I1	Console Mast Cover (L)	1
81	PP100051-I1	Console Mast Cover (R)	1
82	P060252-A1	Ø25 × Ø25 × 15T Rubber Foot Pad	2
83	P060089-I1	Rear Stabilizer Cover (A)	2
84	P060164-I1	Rear Stabilizer Cover (B)	2
85	P040078-I1	Aluminum Axle End Cap	2
88	M030002-Z0	Aluminum Track	2
89	M040001	Support Aluminum Cover	1
90	K090005	Idler Bolt Bearing	3
91	P050015-A1	Transportation Wheel	2
92	J139411	M4 × 5T Nylon Nut	2
93	J094502	M4 × 12mm Phillips Head Screw	2
94	C050036	Carriage Bolt	2
95	J010502-Z1	5/16" × UNC18 × 3/4" Hex Head Bolt	6
96	J020508AB-Z1	5/16" × 2" Button Head Socket Bolt	2
97	J092002-Z1	M5 × 12mm Phillips Head Screw	36
98	J010002-ZZ	1/4" × UNC20 × 3/4" Hex Head Bolt	8
99	J310001-Z4	Ø25 C Ring	2
100	J310002-Z4	Ø17 C Ring	5
101	J139262-Y3	M8 × 9T Nylon Nut	1
102	J139461-Z1	1/4" × 8T Nylon Nut	4
103	J139062-Z1	5/16" × 7T Nylon Nut	2
104	J129021-Y3	3/8" × 7T Nut	8
105	J210003-Z1	Ø3/8" × Ø19 × 1.5T Flat Washer	4
106	J210001-Z1	Ø5/16" × Ø35 × 1.5T Flat Washer	4
107	J210009-Z1	Ø5/16" × Ø23 × 1.5T Flat Washer	6

KEY NO.	PART NO.	DESCRIPTION	Q'TY
108	J083012K-Z1	M8 × 170mm J Bolt	1
109	J250002-Z4	Ø17 × 0.3T Wave Washer	12
110	J367105-Z1	Ø5 × 16L Tapping Screw	6
111	J396917-Z1	4 × 15mm Sheet Metal Screw	1
112	J526915-Z1	4 × 19mm Sheet Metal Screw	7
113	J377105-Z1	5 × 16mm Tapping Screw	16
114	J517007-Z1	3 × 20mm Tapping Screw	4
115	J210012-Z1	Ø1/4" × 19mm Flat Washer	17
116	J367114-Z1	5 × 19mm Tapping Screw	2
117	J210016-Z1	Ø1/4" × 13 × 1.0T Flat Washer	8
118	J260006-Z1	Ø1/4" Split Washer	8
119	J092503-Z1	M6 × 15mm Phillips Head Screw	6
120	J010503-ZG	5/16" × UNC18 × 5/8" Hex Head Bolt	2
121	J320002-Z1	7 × 7 × 25mm Woodruff Key	2
122	J033006-ZK	M8 × 30mm Socket Head Cap Bolt	2
123	J341008-Y3	3/8" × 2" Flat Head Socket Bolt	4
124	J010519-Z9	5/16" × 12mm Hex Head Bolt	2
125	J129522	M14 × 7mm Nut	2
126	J030520-YQ	5/16" × UNC18 × 15mm Socket Head Cap Bolt	2
127	J021009S2-ZJ	3/8" × 2-1/4" Button Head Socket Bolt	4
128	J021015L-ZJ	3/8" × UNC16 × 3-3/4" Button Head Socket Bolt	6
129	J220004-Z1	Ø3/8" × 23 × 2.0T Curved Washer	6
130	J210003-Z1	Ø3/8" × Ø19 × 1.5T Flat Washer	4
131	J092001-Z9	M5 × 10mm Phillips Head Screw	8
132	J033005-Z1	M8 × 25mm Socket Head Cap Bolt	4
133	J250001-Z4	Ø25 Wave Washer	3
134	J396804-Z1	3.5 × 12mm Sheet Metal Screw	18
135	J011002-ZR	3/8" × 3/4" Hex Head Bolt	2
136	J139361-Z1	M10 × 8T Nylon Nut	2
137	J080003P-Z1	M10 × 1.5(14mm) Bolt	2
138	J210022-Z1	Ø3/8" × 30 × 2.0T Flat Washer	2
139	J330004	13/14mm Wrench	1
140	J330009	L Allen Wrench	1
141	J330013-Z1	M12 L Allen Wrench	1
142	J330015-Z1	17mm Wrench	1
143	J330008	Phillips Head Screw Driver	1
144	J354001-Z1	M3 × 10mm Phillips Head Screw	7
148	D020627	Control Power Board	1
149	F092001	1600mm Communication Cable	1
150	E070052	1600mm Csafe Connecting Wire	1
151	E070923-01	1600mm Hdmi Connecting Wire	1
152	E022202	1650mm Computer Cable	1
153	B060105-Z1	Controller Back Plate	1
155	E040059	300mm Ground Wire	1
157	J270001-Z1	M5 Star Washer	1

# GETTING ON/OFF YOUR ELLIPTICAL

## IMPORTANT

The elliptical comes with two Dual Action Handles and a Stationary Handlebar. Always hold the Stationary Handlebar when getting on and off the elliptical. First-time users should familiarize themselves with using the elliptical by using the Stationary Handlebar first and then progressing to the Dual Action Handles.

**Once you have familiarized yourself with using the elliptical, you can progress to using the Dual-Action Handles to provide a total body workout. Hands can be positioned on the Dual Action Handles at the most appropriate position for your height and arm length.**

1. Caution should always be taken when getting on and off an exercise machine.
2. Please follow the safety steps below.
3. Ensure the left Foot Pedal is in the lowest position and grasp the Stationary Handlebar with both hands.
4. Place your left foot on the left Foot Pedal and get secure.
5. Lift your right foot over the machine and place it on the right Foot Pedal. Get balanced and begin your workout.

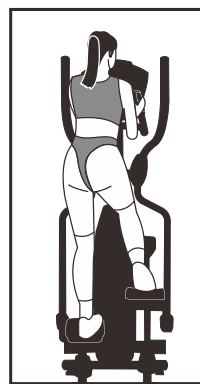
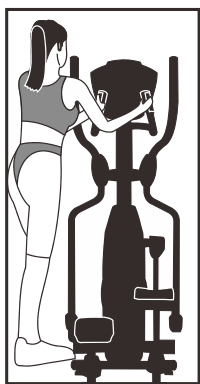

## Important

To get off, come to a complete stop and reverse the procedure.

Always wear rubber-soled shoes, such as tennis shoes.

It is recommended that you keep at least one hand on the Stationary Handlebar at all times, especially when getting on or off. If you are performing a walking action with your arms or doing upper body strength training exercises, ensure you are well balanced.

All equipment should be set up and operated on solid, level surfaces.

## Correct Position

Your body should be in an upright position so that your back is straight. Keep your head up to minimize neck and upper back strain.

Always try and use the elliptical in a rhythmical and smooth motion. If you find yourself feeling uncomfortable or experiencing a surging type of feeling, there is probably too much tension.

The elliptical can be used in forward or reverse motion.

When going in reverse, bend your knees slightly more. More emphasis is on the buttocks and hamstrings in the reverse motion.

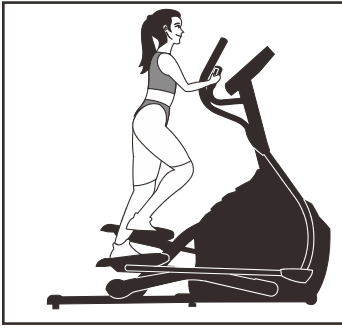

## MOVING YOUR ELLIPTICAL

The elliptical can be easily moved from room to room.



1. Move to the rear of the machine and ensure swing arms are even. Squat down, then grasp the handle of the rear Stabilizer.

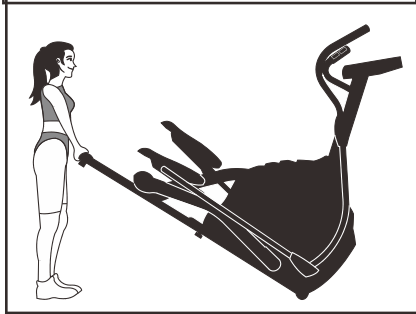

2. Lift up with legs to transport elliptical.

# TRAINING GUIDELINES

## EXERCISE

Exercise is one of the most important factors in the overall health of an individual. Listed among its benefits are:

- Increased capacity for physical work (strength endurance)
- Increased cardiovascular (heart and arteries/veins) and respiratory efficiency
- Decreased risk of coronary heart disease
- Changes in body metabolism, e.g. losing weight
- Delaying the physiological effects of age
- Physiological effects, e.g. reduction in stress, increase in self-confidence, etc.

## BASIC COMPONENTS OF PHYSICAL FITNESS

**There are four all-encompassing components of physical fitness, and we need to briefly define each and clarify its role.**

**Strength** is the capacity of a muscle to exert a force against resistance. Strength contributes to power and speed and is of great importance to a majority of sportspeople.

**Muscular Endurance** is the capacity to exert a force repeatedly over a period of time, e.g. it is the capacity of your legs to carry you 10 Km without stopping.

**Flexibility** is the range of motion about a joint. Improving flexibility involves the stretching of muscles and tendons to maintain or increase suppleness and provides increased resistance to muscle injury or soreness.

**Cardio-Respiratory Endurance** is an essential component of physical fitness. It is the efficient functioning of the heart and lungs

## AEROBIC FITNESS

The largest amount of oxygen that you can use per minute during exercise is called your maximum oxygen uptake (MVo<sub>2</sub>). This is often referred to as your aerobic capacity.

The effort that you can exert over a prolonged period of time is limited by your ability to deliver oxygen to the working muscles. Regular vigorous exercise produces a training effect that can increase your aerobic capacity by as much as 20 to 30%. An increased MVO<sub>2</sub> indicates an increased ability of the heart to pump blood, of the lungs to ventilate oxygen and of the muscles to take up oxygen.

## ANAEROBIC TRAINING

This means “without oxygen” and is the output of energy when the oxygen supply is insufficient to meet the body’s long-term energy demands. (For example, 100-meter sprint).

## The Training Threshold

**This is the minimum level of exercise which is required to produce significant improvements in any physical fitness parameter.**

## Progression

As you become fitter, a higher intensity of exercise is required to create an overload and therefore provide continued improvement



## **Overload**

This is where you exercise at a level above that which can be carried out comfortably. The intensity, duration and frequency of exercise should be above the training threshold and should be gradually increased as the body adapts to the increasing demands. As your fitness level improves, so the training threshold should be raised.

Working through your program and gradually increasing the overload factor is important.

## **Specificity**

Different forms of exercise produce different results. The type of exercise that is carried out is specific both to the muscle groups being used and to the energy source involved.

There is little transfer of the effects of exercise, i.e. from strength training to cardiovascular fitness.

That is why it is important to have an exercise program tailored to your specific needs.

## **Reversibility**

If you stop exercising or do not do your program often enough, you will lose the benefits you have gained. Regular workouts are the key to success.

## **WARM-UP**

Every exercise program should start with a warm-up where the body is prepared for the effort to come. It should be gentle and preferably use the muscles to be involved later.

Stretching should be included in both your warm-up and cool-down and should be performed after 3-5 minutes of low-intensity aerobic activity or callisthenic type exercise.

## **Warm Down or Cool Down**

This involves a gradual decrease in the intensity of the exercise session. Following exercise, a large supply of blood remains in the working muscles. If it is not returned promptly to the central circulation, pooling of blood may occur in the muscles.

## **Heart Rate**

As you exercise, so the rate at which your heartbeat also increases. This is often used as a measure of the required intensity of exercise. You need to exercise hard enough to condition your circulatory system and increase your pulse rate, but not enough to strain your heart.

Your initial level of fitness is important in developing an exercise program for you. If you are starting off, you can get a good training effect with a heart rate of 110-120 beats per minute (BPM). If you are fitter, you will need a higher threshold of stimulation.

To begin with, you should exercise at a level that elevates your heart rate to about 65 to 70% of your maximum. If you find this is too easy, you may want to increase it, but it is better to lean on the conservative side.

As a rule of thumb, the maximum heart rate is 220 minus your age. As you increase in age, so your heart, like other muscles, loses some of its efficiency. Some of its natural loss is won back as fitness improves.

The following table is a guide to those who are "starting fitness."

Age	25	30	35	40	45	50	55	60	65
Target heart Rate 10 Second Count	23	22	22	21	20	19	19	18	18
Beats per Minute	138	132	132	126	120	114	114	108	108

### **Pulse Count**

The pulse count (on your wrist or carotid artery in the neck, taken with two index fingers) is done for ten seconds, taken a few seconds after you stop exercising. This is for two reasons: (a) 10 seconds is long enough for accuracy, (b) the pulse count is to approximate your BPM rate at the time you are exercising. Since heart rate slows as you recover, a longer count isn't as accurate.

The target is not a magic number but a general guide. If you're above average fitness, you may work quite comfortably, a little above that suggested for your age group.

The following table is a guide to those who are keeping fit. Here we are working at about 80% of maximum.

Age	25	30	35	40	45	50	55	60	65
Target heart Rate 10 Second Count	26	26	25	24	23	22	22	21	20
Beats per Minute	156	156	150	144	138	132	132	126	120

Don't push yourself too hard to reach the figures on this table. It can be very uncomfortable if you overdo it. Let it happen naturally as you work through your program. Remember, the target is a guide, not a rule; a little above or below is just fine.

Two final comments:(1) don't be concerned with day-to-day variations in your pulse rate; being under pressure or not enough sleep can affect it;(2) your pulse rate is a guide, don't become a slave to it.

### **ENDURANCE CIRCUIT TRAINING**

Cardiovascular endurance, muscle, strength, flexibility and coordination are all necessary for maximum fitness. The principle behind circuit training is to give a person all the essentials at one time by going through your exercise program moving as fast as possible between each exercise. This increases the heart rate and sustains it, which improves the fitness level. Do not introduce this circuit training effect until you have reached an advanced program stage.

### **Body Building**

Is often used synonymously with strength training. The fundamental principle here is OVERLOAD. Here, the muscle works against greater loads than usual. This can be done by increasing the load you are working against.

### **Patronization**

This is the term used to vary your exercise program for both physiological and psychological benefits. In your overall program, you should vary the workload, frequency and intensity. The body responds better to variety, and so do you. In addition, when you feel yourself getting "stale", bring in periods of lighter exercise to allow the body to recuperate and restore its reserves. You will enjoy your program more and feel better about it.

## **Muscle Soreness**

For the first week or so, this may be the only indication you have that you are on an exercise program. This, of course, does depend on your overall fitness level. A confirmation that you are on the correct program is a very slight soreness in most major muscle groups. This is quite normal and will disappear in a matter of days.

If you experience major discomfort, you may be on a program that is too advanced, or you have increased your program too rapidly.

If you experience PAIN during or after exercise, your body is telling you something.

Stop exercising and consult your doctor.

## **WHAT TO WEAR**

Wear clothing that will not restrict your movement in any way while exercising. Clothes should be light enough to allow the body to cool. Excessive clothing that causes you to perspire more than you normally would while exercising gives you no advantage. The extra weight you lose is body fluid and will be replaced with the next glass of water you drink. It is advisable to wear a pair of gym or running shoes or "sneakers."

## **Breathing during Exercise**

Do not hold your breath while exercising. Breathe normally as much as possible. Remember, breathing involves the intake and distribution of oxygen, which feeds the working muscles.

## **Rest periods**

Once you start your exercise program, you should continue through to the end. Do not break off halfway through and then restart at the same place later on without going through the warm-up stage again.

The rest period required between strength training exercises may vary from person to person. This will depend mostly on your level of fitness and the program you have chosen. Rest between exercises by all means, but do not allow this to exceed two minutes. Most people manage with half-minute to one minute rest periods

# STRETCHING

Stretching should be included in both your warm-up and cool-down and should be performed after 3-5 minutes of low-intensity aerobic activity or callisthenic type exercise. Movements should be performed slowly and smoothly, with no bouncing or jerking. Move into the stretch until slight tension; no pain is felt in the muscle and hold for 20-30 seconds. Breathing should be slow, rhythmical and under control, making sure never to hold your breath.

## HEAD ROLLS

Rotate your head to the right for one count, feeling the stretch up the left side of your neck. Next, rotate your head back for one count, stretch your chin to the ceiling, and let your mouth open. Rotate your head to the left for one count, and finally, drop your head to your chest for one count.

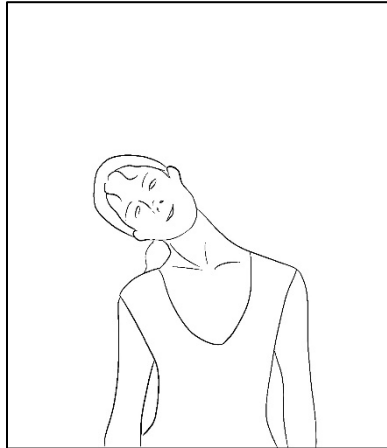

## SHOULDER LIFTS

Lift your right shoulder toward your ear for one count. Then lift your left shoulder for one count as you lower your right shoulder.

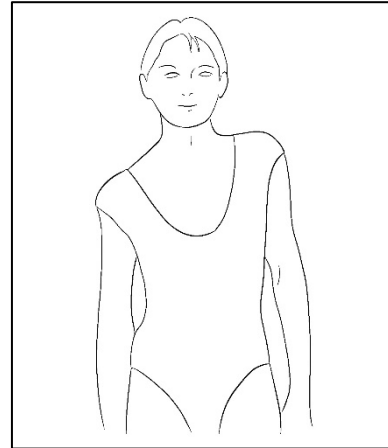

## SIDE STRETCHES

Open your arms to the side and continue lifting them until they are over your head. Reach your right arm as far upward toward the ceiling as you can for one count. Feel the stretch up your right side. Repeat this action with your left foot left arm.

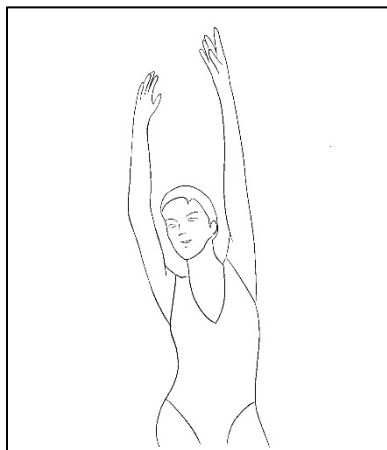

## QUADRICEPS STRETCH

With one hand against a wall for balance, reach behind you and pull your right foot up. Bring your heel as close to your buttocks as possible. Hold for 15 counts and repeat with left foot up.

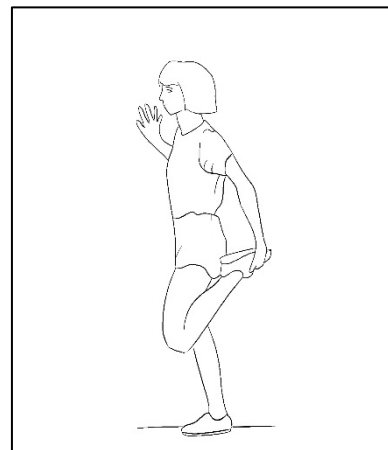

### **INNER THIGH STRETCH**

Sit with the soles of your feet together with your knees pointing outward. Pull your feet as close to your groin as possible. Gently push your knees towards the floor. Hold for 15 counts.

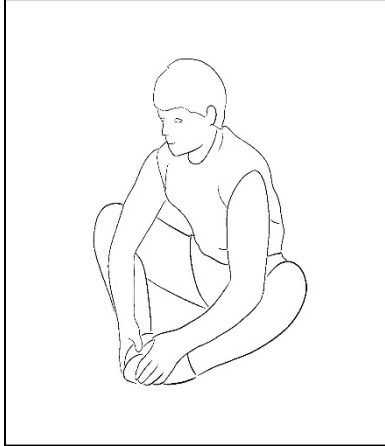

### **TOE TOUCHES**

Slowly bend forward from your waist, letting your back and shoulders relax as you stretch toward your toes. Reach down as far as you can and hold for 15 counts.

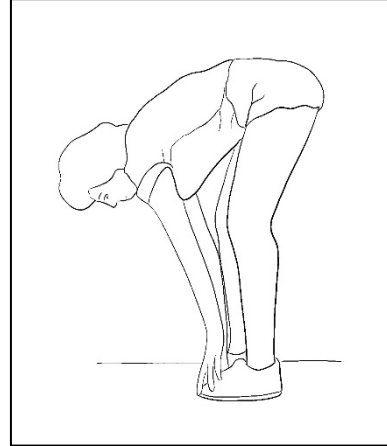

### **HAMSTRING STRETCHES**

Sit with your right leg extended. Rest the sole of your left foot against your right inner thigh. Stretch your toe as far as possible. Hold for 15 counts. Relax and then repeat with left leg extended.

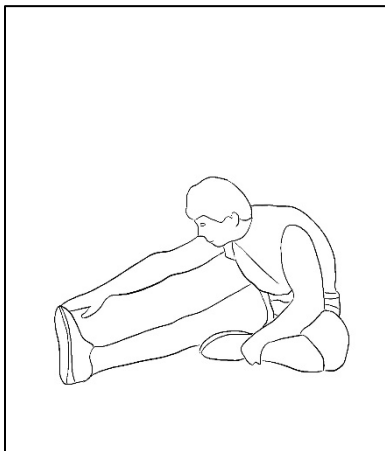

### **CALF / ACHILLES STRETCH**

Lean against a wall with your left leg in front of the right and your arms forward. Keep toward your right leg straight, and the left foot on the floor, then bend the left leg and lean forward by moving your hips toward the wall. Hold, then repeat on the other side for 15 counts.

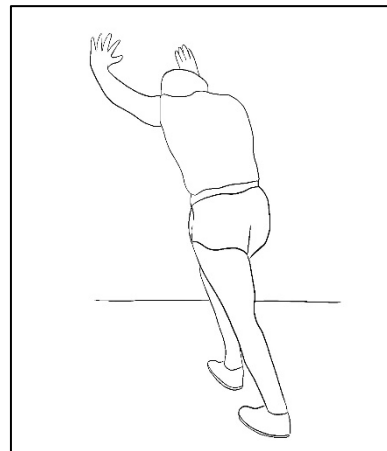

# MANUFACTURER'S LIMITED WARRANTY

Dyaco Canada Inc. warrants all its Spirit elliptical for a period of time listed below, from the date of retail sale, as determined by a sales receipt. Dyaco Canada Inc.'s responsibilities include providing new or remanufactured parts, at Dyaco Canada Inc.'s option, and technical support to our independent dealers and servicing organizations. In the absence of a dealer or service organization, these warranties will be administered by Dyaco Canada Inc. directly to the facility. The warranty period applies to the following components:

## Home Warranty

Frame, Motor & Deck	Lifetime
Electronics	10 Years
Parts	10 Years
Labour	2 Years

## Light Commercial Warranty (Non-dues paying facility)

Frame	Lifetime
Electronics	5 Years
Parts	5 Years (Console 3 years)
Labour	2 Years (Console 1 year)

**This warranty is not transferable and is extended only to the original owner.**

## NORMAL RESPONSIBILITIES OF THE FACILITY

The facility is responsible for the items listed below:

1. The warranty registration can be completed online. Visit [www.dyaco.ca/warranty.html](http://www.dyaco.ca/warranty.html) and complete the warranty registration.
2. Proper use of the elliptical in accordance with the instructions provided in this manual.
3. Proper installation in accordance with instructions provided with the elliptical and with all local electric codes.
4. Proper connection to a grounded power supply of sufficient voltage, replacement of blown fuses, repair of loose connections or defects in facility wiring.
5. Expenses for making the elliptical accessible for servicing, including any item that was not part of the elliptical at the time it was shipped from the factory.
6. Damages to the elliptical finish during shipping, installation or following installation.
7. Routine maintenance of this unit as specified in this manual.

## EXCLUSIONS

This warranty does not cover the following:

1. CONSEQUENTIAL, COLLATERAL, OR INCIDENTAL DAMAGES SUCH AS PROPERTY DAMAGE AND INCIDENTAL EXPENSES RESULTING FROM ANY BREACH OF THIS WRITTEN OR ANY IMPLIED WARRANTY.  
Note: Some areas do not allow the exclusion or limitation of incidental or consequential damages, so this limitation or exclusion may not apply to you.
2. Service call reimbursement to the facility. Service call reimbursement to the dealer that does not involve malfunction or defects in workmanship or material, for units that are beyond the warranty period, for units that are beyond the service call reimbursement period, for elliptical not requiring component replacement.
3. Damages caused by services performed by persons other than authorized Dyaco Canada Inc. service companies; use of parts other than original Dyaco Canada Inc. parts; or external causes such as corrosion, discoloration of paint or plastic, alterations, modifications, abuse, misuse, accident, improper maintenance, inadequate power supply, or acts of God.
4. Products with original serial numbers that have been removed or altered.
5. Products that have been: sold, transferred, bartered, or given to a third party.
6. Products that do not have a warranty registration card on file at Dyaco Canada Inc. Dyaco Canada Inc. reserves the right to request proof of purchase if no warranty record exists for the product.
7. THIS WARRANTY IS EXPRESSLY IN LIEU OF ALL OTHER WARRANTIES EXPRESSED OR IMPLIED, INCLUDING THE WARRANTIES OF MERCHANTABILITY AND/OR FITNESS FOR A PARTICULAR PURPOSE.
8. Warranties outside of Canada may vary. Please contact your local dealer or Dyaco Canada for details.

## SERVICE

The sales receipt establishes the labour warranty period should service be required. If service is performed, it is in your best interest to obtain and keep all receipts. This written warranty gives you specific legal rights. Service under this warranty must be obtained by following these steps, in order:

1. Contact your selling authorized Spirit dealer or Dyaco Canada.
2. If you have any questions about your new product or questions about the warranty contact Dyaco Canada Inc. at 1-888-707-1880.
3. If no local service is available, Dyaco Canada Inc. will repair or replace the parts, at Dyaco Canada Inc.'s option, within the warranty period at no charge for parts. All transportation costs, both to our factory and upon return to the facility, are the responsibility of the facility. The facility is responsible for adequate packaging upon return to Dyaco Canada Inc. Dyaco Canada Inc. is not responsible for damages that occur during shipping. Make all freight damage claims with the appropriate freight carrier. DO NOT SHIP ANY UNIT TO OUR FACTORY WITHOUT A RETURN AUTHORIZATION NUMBER. All units arriving without a return authorization number will be refused.
4. For any further information, or to contact our service department by mail, send your correspondence to:

Dyaco Canada Inc.  
5955 Don Murie Street  
Niagara Falls, ON  
L2G 0A9

Product features or specifications as described or illustrated are subject to change without notice. All warranties are made by Dyaco Canada.

Customer Service 1-888-707-1880  
Email: [customerservice@dyaco.ca](mailto:customerservice@dyaco.ca)

# dyaco

Please visit us online for information about our other brands and products manufactured and distributed by Dyaco Canada Inc.

**SPIRIT**

[spiritfitness.ca](http://spiritfitness.ca)

**X** XTERRA

[xterrafitness.ca](http://xterrafitness.ca)

**UFC**

[dyaco.ca/UFC/UFC-home.html](http://dyaco.ca/UFC/UFC-home.html)

**SOLE**  
FITNESS

[solefitness.ca](http://solefitness.ca)

**EVERLAST**

[dyaco.ca/products/everlast.html](http://dyaco.ca/products/everlast.html)

 **Johnny G**  
by **SPIRIT**

[spiritfitness.ca/johnnyg.html](http://spiritfitness.ca/johnnyg.html)

**TRAINOR**  
**SPORTS**

[trainorsports.ca](http://trainorsports.ca)

For more information, please contact Dyaco Canada Inc.

T: 1-888-707-1880 | 5955 Don Murie St., Niagara Falls, Ontario L2G 0A9 | [sales@dyaco.ca](mailto:sales@dyaco.ca)

Dyaco Canada Inc. [dyaco.ca](http://dyaco.ca)