

Owner's Manual

Model No.
16211789000
CR900 ENT

- Assembly
- Operation
- Adjustments
- Parts
- Warranty

CAUTION:
Read and
understand this
manual before
operating unit

SPIRIT



Retain For Future Reference

TABLE OF CONTENTS

Product Registration	3
Important Safety Instructions	6
Important Electrical Informations	7
Important Operation Instructions.....	8
Assembly Instructions.....	10
Operation of Your Bike	16
Program Features.....	25
Using Heart Rate Transmitter (optional)	34
General Maintenance	36
Exploded View Diagram	40
Parts List.....	41
Training Guidelines.....	45
Stretching	49
Manufacturer's Limited Warranty.....	51

Thank you for purchasing our product, please save these instructions. Please do not perform or attempt any customizing, adjustments, repair or maintenance that is not described in this manual.

SPIRIT

**CONGRATULATIONS ON YOUR
NEW BIKE AND WELCOME
TO THE SPIRIT FAMILY!**

Thank you for your purchase of this quality stationary bike trainer from Dyaco Canada Inc. Your new bike was manufactured by one of the leading fitness manufacturers in the world and is backed by one of the most comprehensive warranties available. Through your dealer, Dyaco Canada Inc. will do all we can to make your ownership experience as pleasant as possible for many years to come. The local dealership where you purchased this bike is your administrator for all Dyaco Canada Inc. warranty and service needs. Their responsibility is to provide you with the technical knowledge and service personnel to make your experience more informed and any difficulties easier to remedy.

Please take a moment at this time to record the name of the dealer, their telephone number, and the date of purchase below to make any future, needed contact easy. We appreciate your support and we will always remember that you are the reason that we are in business. Please complete and mail your registration card today and enjoy your new bike.

Yours in Health,
Dyaco Canada Inc.

Name of Dealer _____
Telephone Number of Dealer _____
Purchase Date _____

Product Registration

RECORD YOUR SERIAL NUMBER

Please record the Serial Number of this fitness product in the space provided below.

Serial Number _____

REGISTER YOUR PURCHASE

The self-addressed product registration card must be completed in full and returned to Dyaco Canada Inc.

BEFORE YOU BEGIN

Thank you for choosing the SPIRIT CR900 ENT Bike. We take great pride in producing this quality product and hope it will provide many hours of quality exercise to make you feel better, look better, and enjoy life to its fullest. It's a proven fact that a regular exercise program can improve your physical and mental health. Too often, our busy lifestyles limit our time and opportunity to exercise. The SPIRIT CR900 ENT Bike provides a convenient and simple method to begin your assault on getting your body in shape and achieving a happier and healthier lifestyle. Before reading further, please review the drawing below and familiarize yourself with the parts that are labeled.

Read this manual carefully before using the SPIRIT CR900 ENT Bike. Although Dyaco Canada Inc. constructs its products with the finest materials and uses the highest standards of manufacturing and quality control, there can sometimes be missing parts or incorrectly sized parts. If you have any questions or problems with the parts included with your SPIRIT CR900 ENT Bike, please do not return the product. Contact us **FIRST!** If a part is missing or defective call us toll free at 1-888-707-1880. Our Customer Service Staff are available to assist you from 8:30 A.M. to 5:00 P.M. (Eastern Time) Monday through Friday. Be sure to have the name and model number of the product available when you contact us.

SAFETY PRECAUTIONS

IMPORTANT SAFETY INFORMATION

READ ALL INSTRUCTIONS BEFORE USING THIS BIKE

CAUTION: Before starting any exercise program, it is recommended that you consult your physician.

Thank you for purchasing our product. Even though we go to great efforts to ensure the quality of each product we produce, occasional errors and/or omissions do occur. In any event should you find this product to have either a defective or a missing part please contact us for a replacement.

This exercise equipment was designed and built for optimum safety. However, certain precautions apply whenever you operate a piece of exercise equipment. Be sure to read the entire manual before assembly and operation of this machine. Also, please note the following safety precautions:

1. Read the OWNER'S OPERATING MANUAL and all accompanying literature and follow it carefully before using your bike.
2. It is the responsibility of the facility to ensure that all users of the bike exerciser are adequately informed of all precautions.
3. If dizziness, nausea, chest pains, or any other abnormal symptoms are experienced while using this equipment, STOP the workout at once. CONSULT A PHYSICIAN IMMEDIATELY.
4. Inspect your exercise equipment prior to exercising to ensure that all nuts and bolts are fully tightened before each use.
5. The bike must be regularly checked for signs of wear and damage. Any part found defective, the part must be replaced with new spare part from the manufacturer.
6. Fitness equipment must always be installed on a flat surface, do not place the unit on a loose rug or uneven surface. It is recommended to use an equipment mat to prevent the unit from moving while it is being used, which could possibly scratch or damage the surface of your floor. Keep the bike exerciser indoors, away from moisture and dust.
7. No changes must be made which might compromise the safety of the equipment.
8. It is recommended to have a minimum of 1' safe clearance around the exercise equipment while in use.
9. Keep children and pets away from this equipment at all times while exercising.
10. Warm up 5 to 10 minutes before each workout and cool down 5 to 10 minutes afterward. This allows your heart rate to gradually increase and decrease and will help prevent you from straining muscles.
11. Never hold your breath while exercising. Breathing should remain at a normal rate in conjunction with the level of exercise being performed.
12. Always wear suitable clothing and footwear while exercising. Do not wear loose fitting clothing that could become entangled with the moving parts of your bike.
13. Always hold the handlebars when mounting, dismounting, or using the bike exerciser.
14. Keep your back straight when using the bike exerciser; do not arch your back.
15. If decals on the bike exerciser are missing or illegible, please call our customer service department toll free at 1-888-707-1880 and order a replacement decal.
16. Care must be taken when lifting or moving the equipment, so as not to injure your back. Always use proper lifting techniques
17. User weight should not exceed 450 lbs (204 kgs)

WARNING: Before beginning any exercise program consult your physician. This is especially important for individuals over the age of 35 or persons with pre-existing health problems. Read all instructions before using any fitness equipment. We assume no responsibility from personal injury or property damage sustained by or through the use of this product.

SAVE THESE INSTRUCTIONS

IMPORTANT SAFETY INSTRUCTIONS

WARNING - Read all instructions before using this equipment.

DANGER - To reduce the risk of electric shock disconnect your bike from the electrical outlet prior to cleaning and/or service work.

WARNING - To reduce the risk of burns, fire, electric shock, or injury to persons, install the bike on a flat level surface with access to a 110-volt,20-amp grounded outlet with only the bike plugged into the circuit.

DO NOT USE AN EXTENSION CORD UNLESS IT IS A 14 AWG OR BETTER. WITH ONLY ONE OUTLET ON THE END.

- Do not operate bike on deeply padded, plush or shag carpet. Damage to both carpet and bike may result.
- Keep children under the age of 13 away from the bike. There are obvious pinch points and other caution areas that can cause harm.
- Keep hands away from all moving parts.
- Never operate the bike if it has a damaged cord or plug. If the bike is not working properly, call your dealer.
- Keep the cord away from heated surfaces.
- Do not operate where aerosol spray products are being used or where oxygen is being administered. Sparks from the motor may ignite a highly gaseous environment.
- Never drop or insert any object into any openings.
- Do not use outdoors.
- To disconnect, turn all controls to the off position and then remove the plug from the outlet.
- Do not attempt to use your bike for any purpose other than for the purpose it is intended.
- The hand pulse sensors are not medical devices. Various factors, including the user's movement, may affect the accuracy of heart rate readings. The pulse sensors are intended only as exercise aids in determining heart rate trends in general.
- Wear proper shoes. High heels, dress shoes, sandals or bare feet are not suitable for use on your bike. Quality athletic shoes are recommended to avoid leg fatigue.
- This equipment is not intended for use by persons with reduced physical, sensory or mental capabilities, or lack of experience and knowledge, unless they have been given supervision or instruction concerning use of the equipment by a person responsible for their safety.

SAVE THESE INSTRUCTIONS - THINK SAFETY!

IMPORTANT ELECTRICAL INFORMATIONS

WARNING!

NEVER remove any cover without first disconnecting AC power.

If voltage varies by ten percent (10%) or more, the performance of your bike may be affected. **Such conditions are not covered under your warranty.** If you suspect the voltage is low, contact your local power company or a licensed electrician for proper testing.

NEVER expose this bike to rain or moisture. This product is **NOT** designed for use out-doors, near a pool or spa, or in any other high humidity environment. The operating temperature specification is 40 to 120 degrees Fahrenheit, and humidity is 95% non-condensing (no water drops forming on surfaces).

GROUNDING INSTRUCTIONS

This product must be grounded. If the bike should malfunction or breakdown, grounding provides a path of least resistance for electric current, reducing the risk of electric shock.

This product is equipped with a cord having an equipment-grounding plug. The plug must be plugged into an appropriate outlet that is properly installed and grounded in accordance with all local codes and ordinances.

DANGER - Improper connection of the equipment-grounding conductor can result in a risk of electric shock. Check with a qualified electrician or serviceman if you are in doubt as to whether the product is properly grounded. Do not modify the plug provided with the product if it will not fit the outlet; have a proper outlet installed by a qualified electrician.

This product is for use on a nominal 110-volt circuit and has a grounding plug that looks like the plug illustrated below. A temporary adapter that looks like the adapter illustrated below may be used to connect this plug to a 2-pole receptacle as shown below if a properly grounded outlet is not available. The temporary adapter should be used only until a properly grounded outlet can be installed by a qualified electrician. The green colored rigid ear-lug, or the like, extending from the adapter, must be connected to a permanent ground such as a properly grounded outlet box cover. Whenever the adapter is used, it must be held in place by a metal screw.

IMPORTANT OPERATION INSTRUCTIONS

- **NEVER** operate this bike without reading and completely understanding the results of any operational change you request from the computer.
- Understand that changes in resistance do not occur immediately. Set your desired resistance on the computer console and release the adjustment key. The computer will obey the command gradually.
- **NEVER** use your bike during an electrical storm. Surges may occur in your facility or household power supply that could damage bike components. Unplug the bike during an electrical storm as a precaution.
- Use caution while participating in other activities while pedaling on your bike; such as watching television, reading, etc. These distractions may result in serious injury.
- Always hold on to a handrail or hand bar while making control changes (resistance, etc.).
- Do not use excessive pressure on console control keys. They are precision set to function properly with little finger pressure. Pushing harder is not going to make the unit go faster or slower. If you feel the buttons are not functioning properly with normal pressure contact your dealer.

WARNING DECAL REPLACEMENT

The decal shown below has been placed on the bike. If the decal is missing or illegible, please call our Customer Service Department toll-free at 1-888-707-1880 to order a replacement decal.

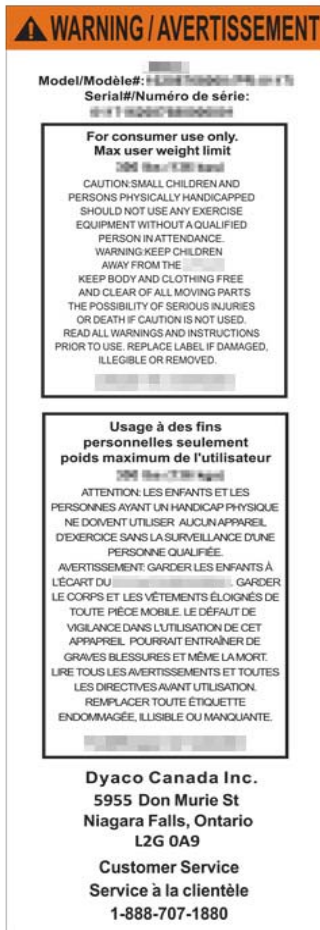

ASSEMBLY INSTRUCTIONS

PRE-ASSEMBLY

1. Cut the straps then along the dotted line on the bottom of the box; lift the box over the unit and unpack.
2. Carefully remove all parts from carton and inspect for any damage or missing parts. If damaged parts are found, or parts are missing, contact your dealer immediately.
3. Locate the hardware package. Remove the tools first. Remove the hardware for each step as needed to avoid confusion. The numbers in the instructions that are in parenthesis (#) correspond to the item number from the assembly drawing for reference.

ASSEMBLY TOOLS

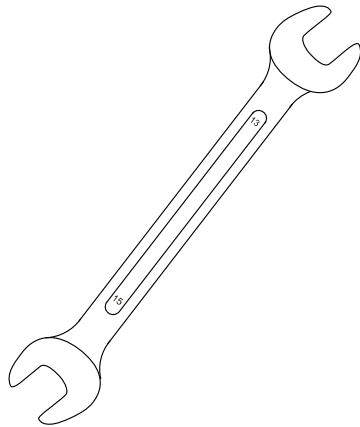

#126. 13/15mm
Wrench (1 pc)

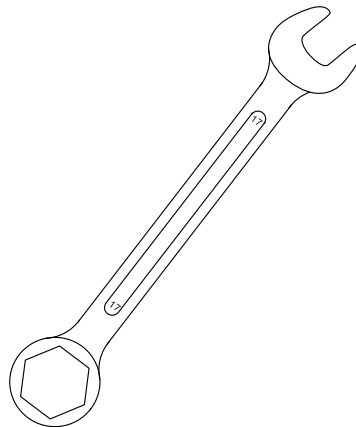

#125. 17 mm
Wrench (2 pc)

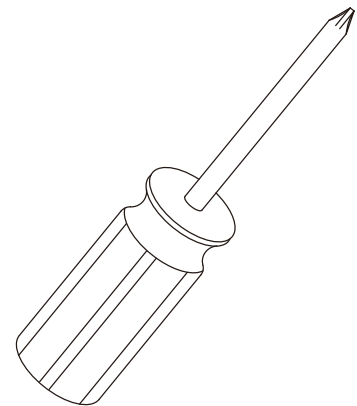

#122. Phillips Head
Screwdriver (1 pc)

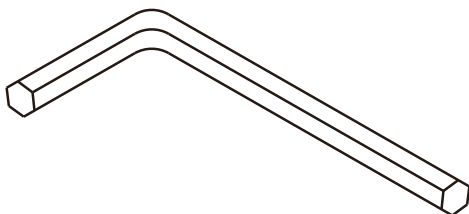

#124. 6mm L Allen Wrench (1 pc)

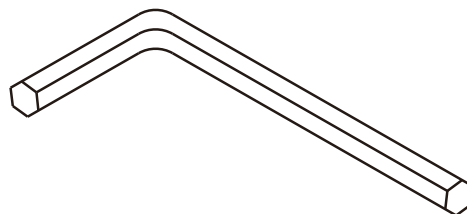

#123. 5mm L Allen Wrench (1 pc)

STEP 1

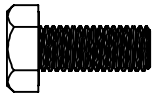

#145 - M10 x 30mm
Hex Head Bolt (2pcs)



#92 - M6 x 12 mm Socket
Head Cap Bolt (6pcs)



#97 - M5 x 12 mm
Phillips Head Screw
(2pcs)

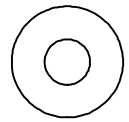

#106 - Ø3/8" x Ø25 x
2.0T Flat Washer (4pcs)



#108 - Ø1/4" x 13 x 1.0T
Flat Washer (6pcs)



#111 - Ø1/4"
Split Washer (6pcs)



#117 - 3.5 x 12mm
Sheet Metal Screw
(5pcs)



#138 - Ø10 x 1.5T
Split Washer (4pcs)

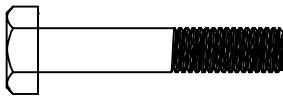

#139 - M10 x 55mm
Hex Head Bolt (2pcs)

STEP 2



#94 - M8 x 25mm
Socket Head Cap Bolt
(2pcs)



#97 - M5 x 12mm
Phillips Head Screw
(8pcs)



#105 - Ø5/16" x Ø18 x
1.5T Flat Washer (2pcs)



#112 - Ø5/16" x 1.5T
Split Washer (2pcs)

STEP 3

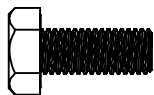

#85 - M10 x 25mm
Hex Head Bolt
(6pcs)

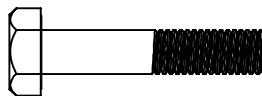

#86 - M10 x 50mm
Hex Head Bolt
(6pcs)



#92 - M6 x 12 mm
Socket Head Cap Bolt
(2pcs)



#101 - M10 x 8T
Nyloc Nut (4pcs)

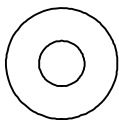

#106 - Ø3/8" x Ø25 x
2.0T Flat Washer (16pcs)



#108 - Ø1/4" x 13 x 1.0T
Flat Washer (2pcs)



#111 - Ø1/4"
Split Washer (2pcs)



#116 - 4 x 12mm
Sheet Metal Screw
(6pcs)

STEP 4



#90 - M8 x 20mm Button
Head Socket Bolt (4pcs)

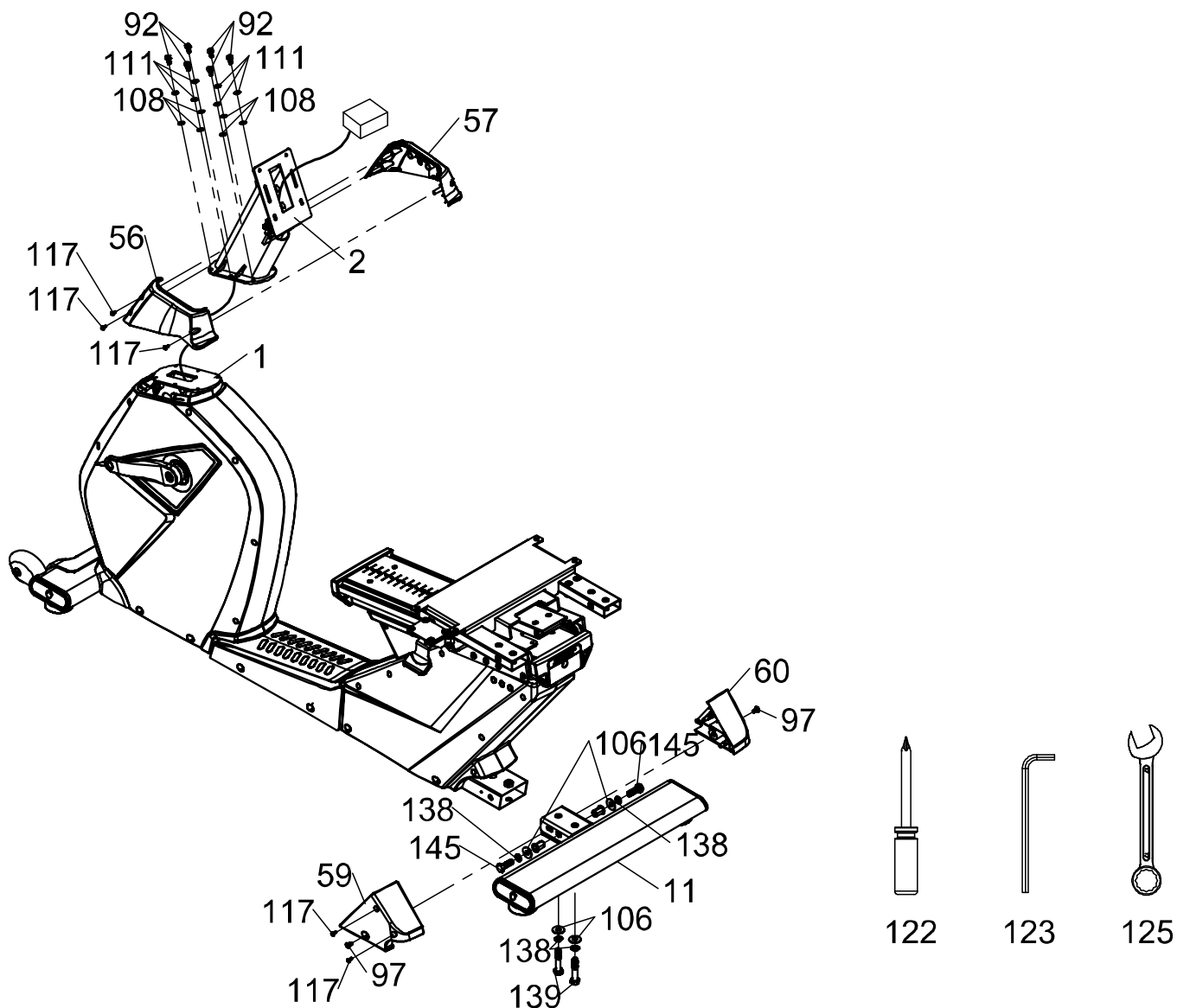

STEP 1

1. Install REAR STABILIZER (11) onto MAIN FRAME (1) with 2 short BOLTS (145), 2 long BOLTS (139), 4 SPLIT WASHERS (138), and 4 WASHERS (106).
2. Attach left and right REAR STABILIZER COVERS (59 & 60) to MAIN FRAME (1) with 2 SCREWS (97). Join together with 2 SELF TAPPING SCREWS (117).
3. Run the WIRING HARNESS through the CONSOLE MAST (2) and out the top.
4. Attach CONSOLE MAST (2) to MAIN FRAME (1) using 6 BOLTS (92), 6 SPLIT WASHERS (111), and 6 WASHERS (108).
5. Place left and right CONSOLE MAST COVERS (56 & 57) around base of CONSOLE MAST (2). Join covers together with 3 SELF TAPPING SCREWS (117).

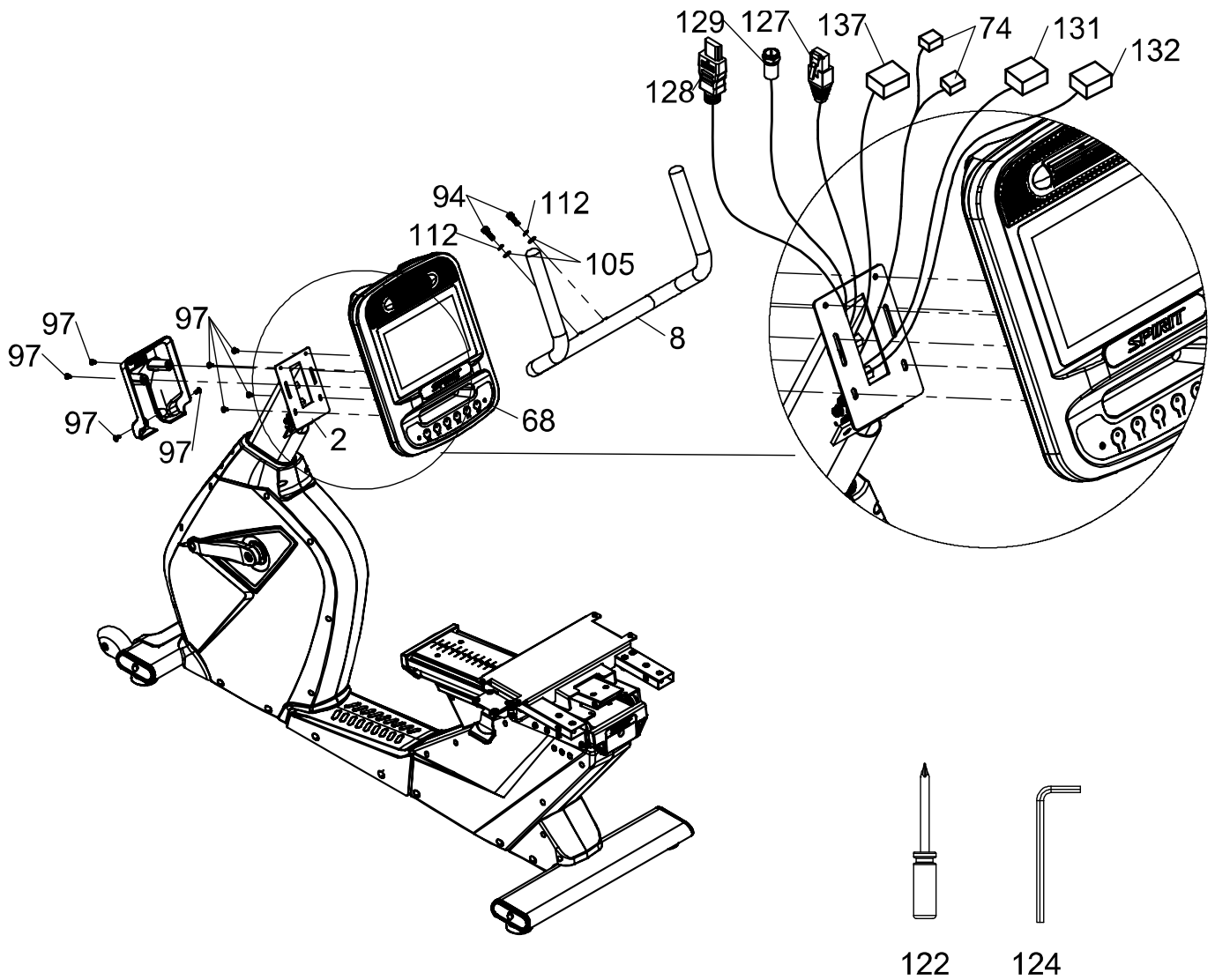

STEP 2

1. Attach FRONT HANDLEBAR (8) to CONSOLE MAST (2) with 2 BOLTS (94), 2 SPLIT WASHERS (112) and 2 WASHERS (105).
2. Connect WIRING HARNESS CABLES (74 to 131) to CONSOLE (68).
3. Attach CONSOLE (68) to CONSOLE MAST (2) with 4 SCREWS (97). Ensure all cables do not become pinched.
4. Attach CONSOLE BRACKET COVER (64) to CONSOLE MAST (2) using 4 SCREWS (97).

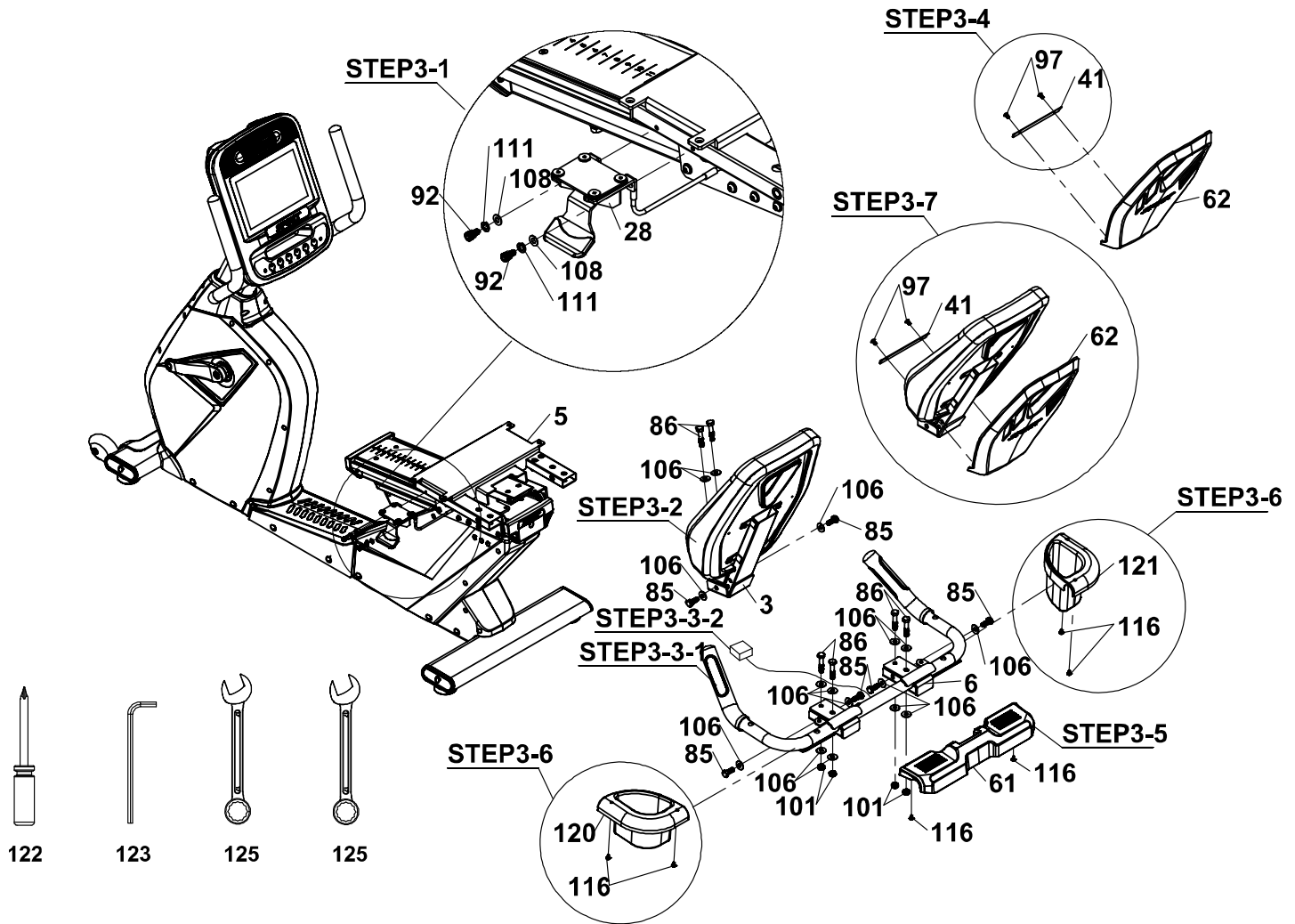

STEP 3

1. Install SEAT RELEASE LEVER (28) onto SEAT CARRIAGE FRAME (5) with 2 BOLTS (92), 2 LOCK WASHERS (111), and 2 WASHERS (108).
2. Install SEAT BACK FRAME (3) onto SEAT CARRIAGE FRAME (5) with 2 short BOLTS (85), 2 long BOLTS (86), and 4 WASHERS (106).
3. Attach REAR HANDLEBAR (6) to SEAT CARRIAGE FRAME (5) using 4 long BOLTS (86), 4 shot BOLTS (85), 12 WASHERS (106), and 4 NUTS (101). And connect the WIRING HARNESS CABLES between REAR HANDLE BAR (6) and SEAT CARRIAGE FRAME (5).
4. Loosen 2 SCREWS (97) to remove SEAT COVER RETAINING BRACKET (41) from SEAT BACK FRAME (3).
5. Attach REAR HANDLEBAR COVER (61) to REAR HANDLEBAR (6) using 2 SELF TAPPING SCREWS (116).
6. Attach CUP HOLDERS (120 & 121) to REAR HANDLEBAR (6) using 4 SELF TAPPING SCREWS (116).
7. Attach SEAT BACK COVER (62) to SEAT BACK FRAME (3). Install SEAT COVER RETAINING BRACKET (41) using 2 SCREWS (97).

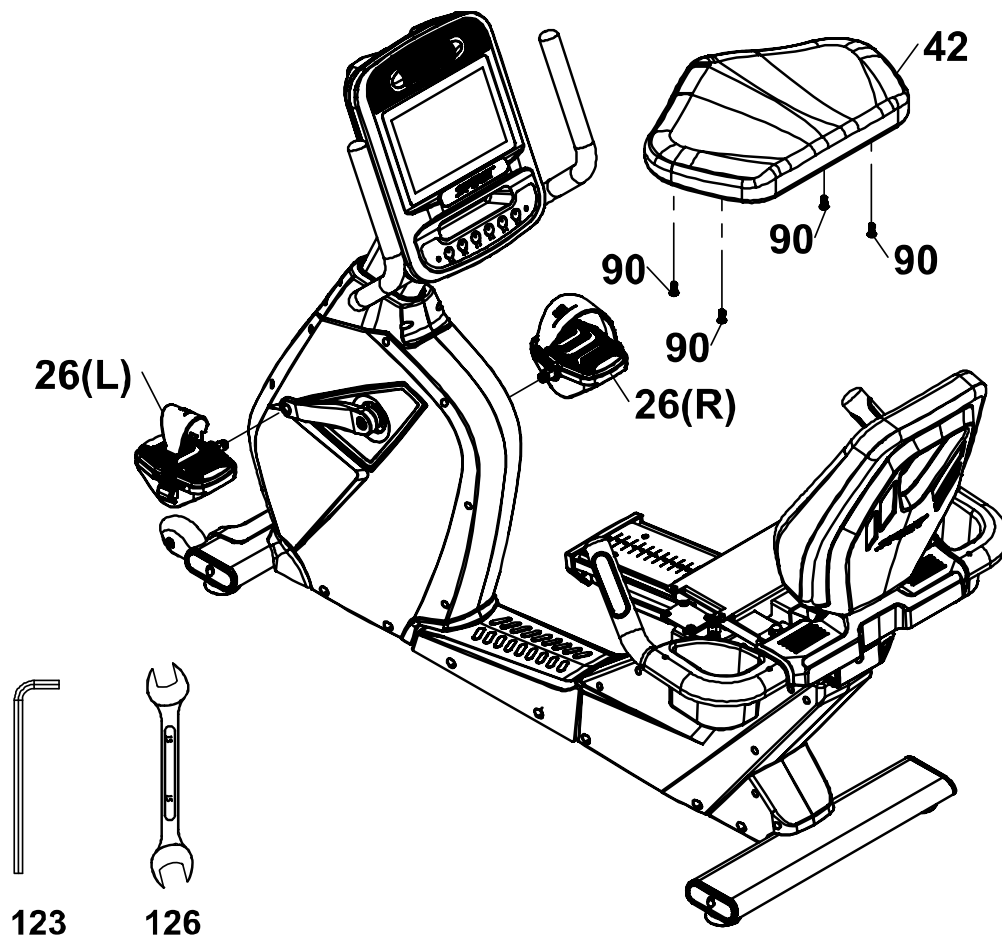

STEP 4

1. Install the PEDALS (26L & 26R) onto the CRANK ARMS (22 & 23). The left pedal has a reverse thread and will be screwed in counterclockwise.
2. Attach BOTTOM SEAT CUSHION (42) to SEAT CARRIAGE FRAME (5) with 4 BOLTS (90).

OPERATION OF YOUR BIKE



Starting the operation

- Plug in the power cord and switch on the main power switch located at the front, below the console.
- When the power is turned on, the screen will show the initial image and then enter the ready mode which is the beginning of the bike operation.

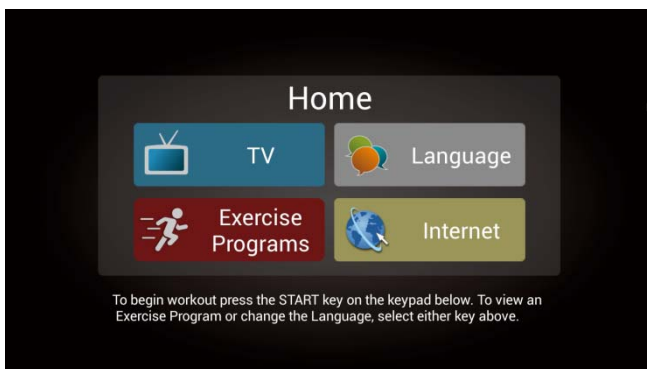

First page image for you to operate by touching the icons.



Quick operating buttons are convenient for basic bike functions.

Quick Start:

- Press “START” button and the console start performing the program. Press “LEVEL” up/down buttons further to change the resistance level you desire.
- Press HOME” button on the top left corner or “STOP” to pause your workout.

Featuring Functions of this Bike:

Touch-control screen is installed for the operation. You can directly touch any functional button on the screen or through buttons on the bottom to control. On the bottom, there are “Resistance” up/down buttons to control the resistance level, “START” button to begin the workout, “STOP” button to pause/stop running and “FAN” button to the fan on or off.

Pause/Stop:

- Press “STOP” button once or “HOME” button on the screen, the bike will stop and keep values of time, distance and calorie on the screen. The screen will count down for 5 minutes then reset.
- Press “START” button to continue the workout during pause.
- Press “STOP” button twice the console will ask you if you want to end the workout. If “STOP” button is pressed the third time, the console will display your workout summary.

Heart Rate Feature:

Pulse (heart rate) on the screen shows the current value of the heart beats per minute. You must hold both left and right stainless-steel sensors to test the pulse. The pulse value will be shown on the screen continuously. You can also use hand pulse sensors for heart rate control. The console can also detect the pulse from a wireless chest strap.

To Turn Off the Bike:

The screen will turn it off (sleep status) when there is no command within 30 minutes. This is called sleeping mode and the bike will stop most of its activity except the minimum circuit detecting system for press buttons so that when there is any button activation, the bike restarts. There is only very little electric current (like a TV turned off) in the sleeping mode. It is fine to leave the main power switch on during sleeping mode.

Audio:

To listen to any audio source with this unit, you must plug a headset into the port on the console.

Below is the instruction for touch screen operation:

- First page HOME

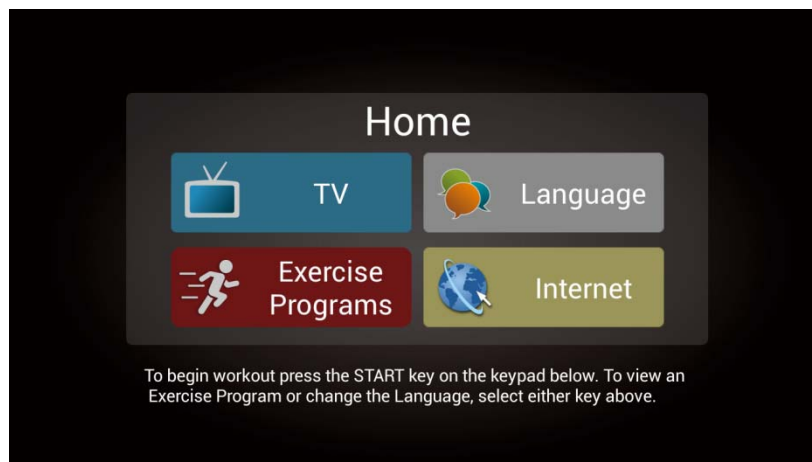

There are four selections. Usually the "Language" is the first selection.

- When you press "Language" button, it enters the menu with all language selections.

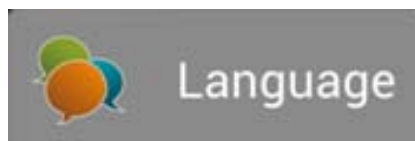

There are 12 languages to choose.

Touch the desired language button to set and the system will return to the first page for the program operation. If you don't want to change the language, press HOME button at the upper left corner to return to the first page.

- When TV button on the first page HOME is pressed, it enters TV interface.

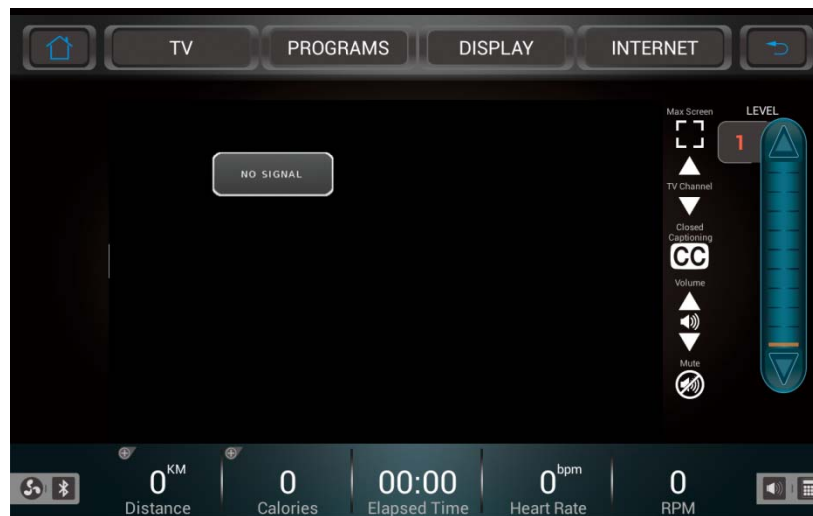

Now you can enjoy TV programs. If you want to work out and enjoy TV program simultaneously, press "START" button to start the bike.



You can change the TV channel by using up/down buttons on the TV channel or channel remote control at bottom right to change the channel. Use up/down buttons on the volume to change the sound volume. Press "Mute" button to switch to silence. Touch Max Screen icon to switch to full screen. When you want to resume the original screen display, just touch the image and the screen resumes. Use level up/down buttons to control the resistance level. When you want to pause, just press "HOME" button at upper left corner or press "STOP" button once and the pause window will show up. If you want to stop, you can choose to end the program or press "STOP" button again to end the program (the console will display a message to ask you if you want to end the workout). Pressing the "STOP" button third time and the console will display a workout summary.

- When you touch “Internet” button on HOME page, it rapidly enters internet interface.

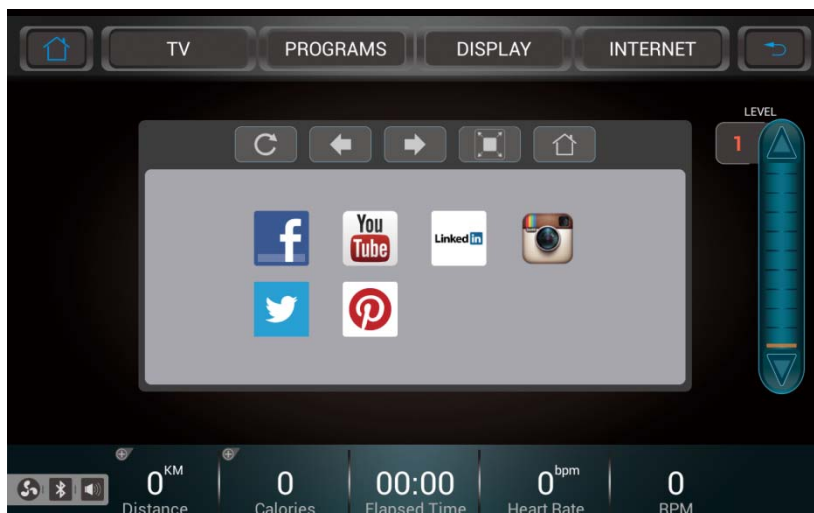

There are 6 internet connections to choose for you to go internet while you are exercising (internet cable connection or WIFI connection is required). Press “START” button of the bike to start it.

Use “level up/down buttons to control the resistance level during the exercise. When you want to pause, just press “HOME” button at left top or press “STOP” button once and the pause window will show up. If you want to end, you can choose to end the program or press “STOP” button again to show the workout summary. If “STOP” button is pressed the third time, the console will return to the initial status (the beginning).

- When you touch “Exercise Program” button on HOME page, it enters “Menu” interface.

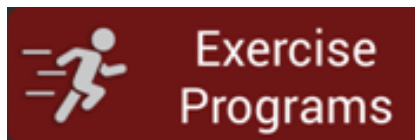

There are 10 program modes in Menu interface.

If you want to choose Manual Program, just touch Manual button on the screen to enter the program for Manual.

MANUAL program:



Then touch the “Profile” button to enter profile interface. If you do not want to do this program, just touch “HOME” icon at left top corner to return to the first page or press “Return” icon at right top corner to return to continue the previous operation. If profile selection is desired, press left or right arrow button to select the program you want.

The image entering the “Profile” interface is as below.

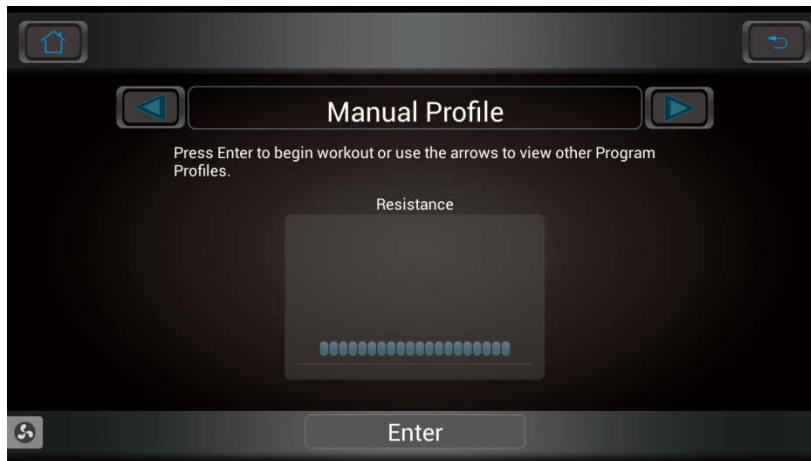

After entering the profile image which is the program you want to perform, press “ENTER” button to enter next image. If not, touch “HOME” icon at left top corner to return to the first page or press “Return” icon at right top corner to return to continue the previous operation. If profile selection is desired, press left or right arrow button to select the program you want.

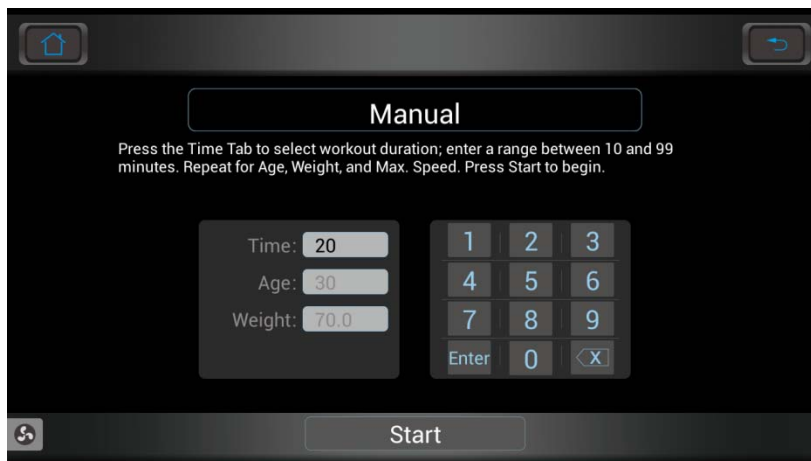

This image is for setting program time, user’s age and weight. Press “ENTER” button after entering parameters to confirm. Then press “START” button to start the Manual Program. If not, press “HOME” button at left top corner to return to the first page or press “Return” icon at right top corner to return to continue the previous operation.

After starting the program, a “SIMPLE” workout view displays as below.

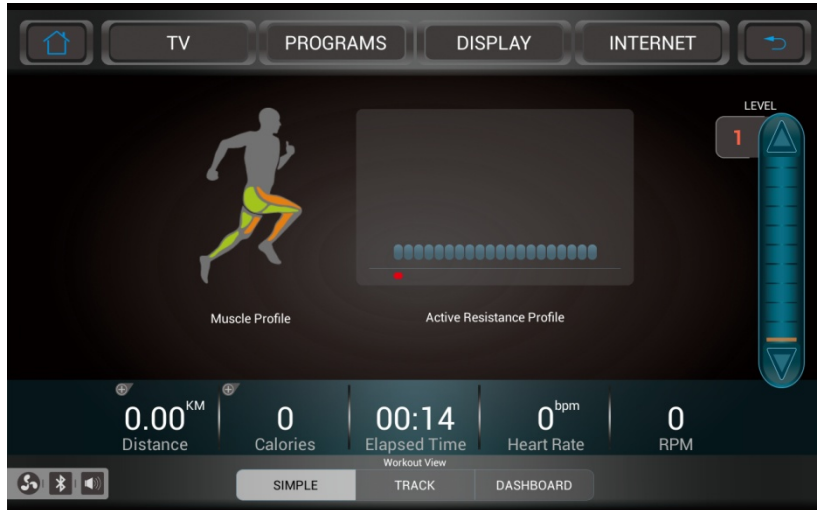

The simple workout view contains all values on the bottom concerning your workout. The resistance level is at the right side and is adjustable with “UP” or “DOWN” button.

The bar chart for the resistance level is in the middle. TV interface button is on top to touch for entering the TV mode, or touch “INTERNET” for entering the internet interface. If “PROGRAM” button is touched, the system will ask you if you want to end the current workout. If “DISPLAY” button is touched, you can access the different workout views.

Touch “TRACK” button to enter the track interface.



The operating is similar with different interface only. The image shows the track with number of laps and other values.

Touch “DASHBOARD” button on the bottom to enter the dashboard interface.

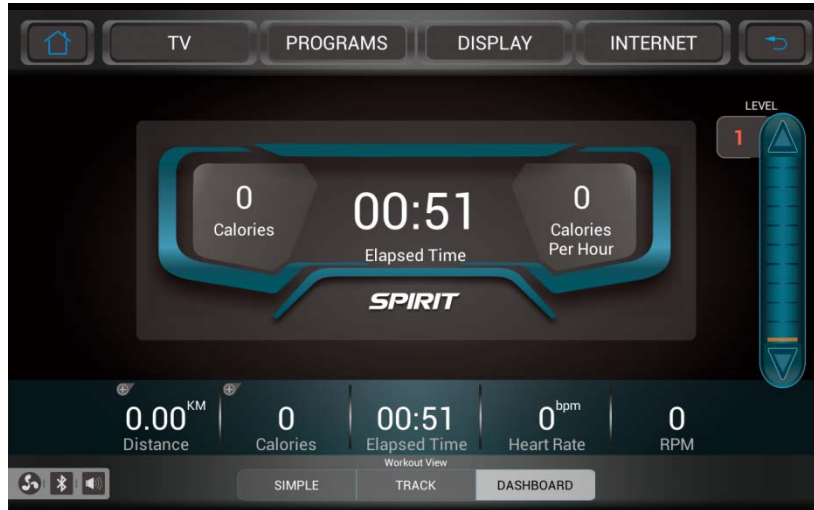

The operating is similar with different interface only. You can choose one of three interfaces on the bottom with your own preference.

When using the first page button or “STOP” button to end the program, it enters the summary image.

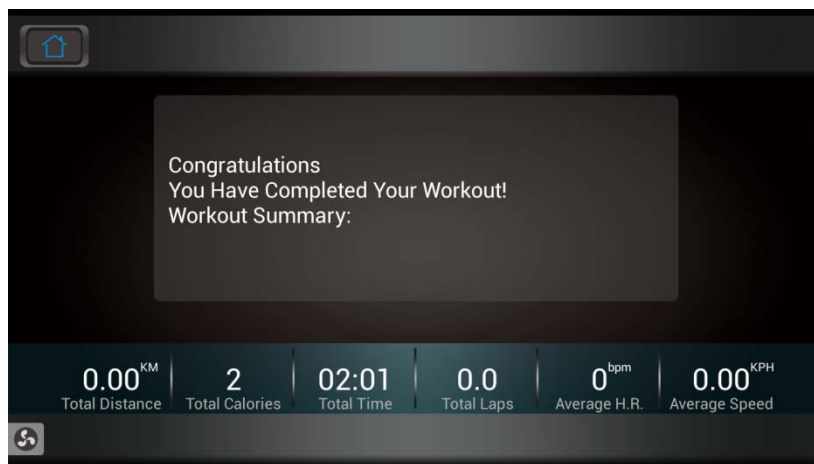

On the summary image, all accumulating values concerning the workout are displayed.

You can touch the HOME button at left top or press “STOP” button to return to the first page image.

Programmable Features

The Spirit Fitness CR900 ENT offers ten preset programs, HILL, FAT BURN, CARDIO, STRENGTH, INTERVAL, HR, CUSTOM, Fitness Test, Constant Power and one Manual program.

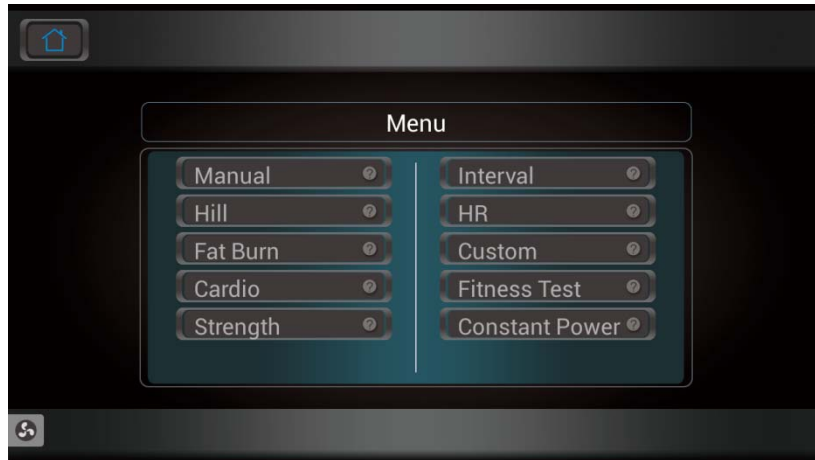

Preset Features:

To choose and start preset program:

- Select a program then press the ENTER key to begin customizing the program with your personal data, or just press the start key to begin the program with the default settings.
- After selecting a program and pressing ENTER to set your personal data, the touch Time window will darken with the default value of 20 minutes. You may use numeric keypads to adjust the time. After adjusting the time, press ENTER confirm and continue. (Default time is 20 minutes)
- The touch Age window will now be darkening a value indicating your Age. Entering the correct Age will affect the Heart rate bar graph accuracy and also needed for the HR programs. use numeric keypads to make adjustments, and then press ENTER confirm and continue. (Default age is 30 years old. Range=10 to 110)
- The touch Weight window will now be darkening a value indicating your Bodyweight. Entering your correct bodyweight affects the Kcal readout accuracy. Use numeric keypads to make adjustments, and then press ENTER confirm and continue. (Default weight is 154 lbs. Range=22 to 333.7)
- The touch Max Level window (For HILL, FAT BURN, CARDIO, STRENGTH, INTERVAL program) will now be darkening a value indicating your resistance. Entering your correct level affects the Mix level readout accuracy. Use numeric keypads to make adjustments, and then press ENTER confirm and continue. (Default mix Level is 5. Range=5 to 40)
- Now press the START key to begin your workout.

Preset program

The bike has five different programs that have been designed for a variety of workout goals. These five programs have factory preset profiles for achieving these different goals. The initial built-in level of difficulty for each program is set to a relatively easy level. You may adjust the level of difficulty (Max level) for each program before beginning by following the instructions in the message window after selecting your program.

Prog	SEG	1	2	3	4	5	6	7	8	9	10	11	12	13	14	15	16	17	18	19	20
Hill	Resistance	50	62.5	62.5	70	70	75	75	87.5	87.5	100	100	87.5	87.5	75	75	70	70	62.5	62.5	80
Fatburn	Resistance	50	62.5	75	100	100	100	100	100	100	100	100	100	100	100	100	100	100	100	75	50
Cardio	Resistance	50	62.5	62.5	70	70	75	75	80	80	87.5	95	95	100	100	100	100	100	87.5	75	50
Strength	Resistance	50	62.5	62.5	70	70	75	75	80	80	87.5	95	95	100	100	100	100	100	87.5	75	50
Interval	Resistance	50	62.5	62.5	100	100	62.5	62.5	100	100	62.5	62.5	100	100	62.5	62.5	100	100	62.5	62.5	50

Hill program:

The Hill program simulates going up and down a hill. The resistance in the pedals will steadily increase and then decrease during the program.

Work Profile

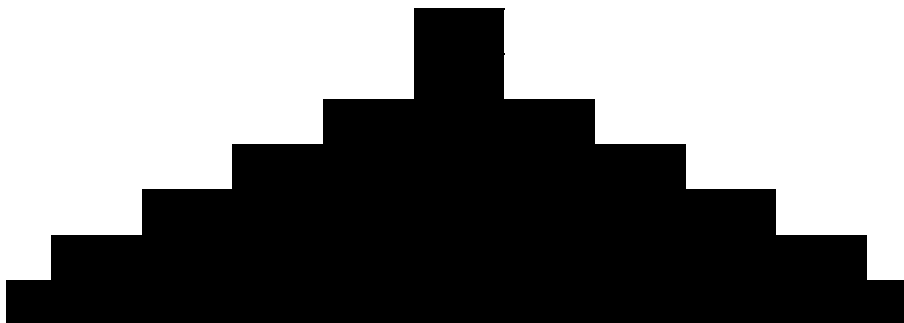

Fat Burn program:

The Fat Burn program is designed, as the name implies, to maximize the burning of fat. There are many schools of thought on the best way to burn fat but most experts agree that a lower exertion level that stays at a steady workload is the best. The absolute best way to burn fat is to keep your heart rate at around 60% to 70% of its maximum potential. This program does not use heart rate but simulates a lower, steady exertion workout.

Work Profile

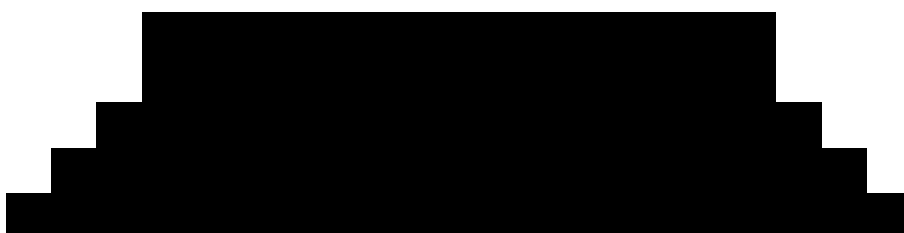

Cardio program:

The Cardio program is designed to increase your Cardio vascular function. This is exercise for your heart and lungs. It will build up your heart muscle and increase blood flow and lung capacity. This is achieved by incorporating a higher level of exertion with slight fluctuations in work.

Work Profile



Strength program:

The Strength program is designed to increase muscular strength in your lower body. This program will steadily increase in resistance to a high level and then keeps you there. This is designed to strengthen and tone your legs and glutes.

Work Profile

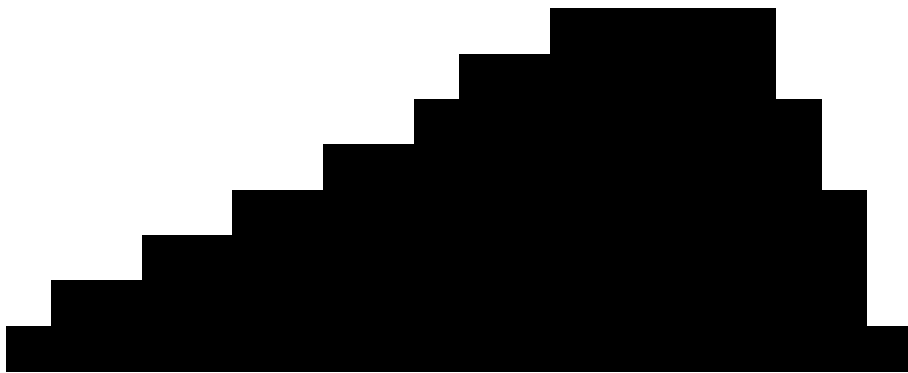

Interval program:

The Interval program takes you through high levels of intensity followed by periods of low intensity. This program increases your endurance by depleting your oxygen level followed by periods of recovery to replenish oxygen. Your cardio vascular system gets programmed to use oxygen more efficiently this way.

Work Profile



Custom Program:

- Select a Custom program then press the ENTER key to begin customizing the program with your personal data, or just press the start key to begin the program with the default settings.
- The window will show the corresponding level profile, user can choose rename program by touching rename icon and entering profile. After new setting, level profile will be show on screen for adjustment.
- Press next key save icon for new level profile then pop out next message window for Time, Age, Weight and Mix level entry.
- Now press the START key to begin your workout test for new program.

Fit-Test program:

The fitness test is based on the YMCA protocol and is a sub-maximal test that uses pre-determined, fixed work levels that are based on your heart rate readings as the test progresses. The test will take anywhere between 6 to 15 minutes to complete, depending on your level of fitness. The test ends when your heart rate reaches 85% of maximum at any time during the test or your heart rate is between 110 bpm and 85% at the end of two consecutive stages. At the end of the test a VO_{2max} score will be given. VO_{2max} stands for Volume of Oxygen uptake which is a measurement of how much oxygen you need to perform a known amount of work.

The YMCA protocol uses two to four 3-minute stages of continuous exercise (see charts below). You will be asked to choose either, Male or Female at the beginning of the test. This choice determines which test parameters will be used during the test as shown in the charts below. The only caveats are that if you are a very de-conditioned Male you need to choose option Female. If you are a very conditioned female you need to choose option Male.

Workload chart for male or very fit female:

1st Stage				50 watts - 300 kgm/min					
HR		< 90			90 - 105			> 105	
2nd Stage		150 watts - 900 kgm/min			125 watts - 750 kgm/min			100 watts - 600 kgm/min	
HR	HR <120	HR 120-135	HR >135	HR <120	HR 120-135	HR >135	HR <120	HR 120-135	HR >135
3rd stage	225 watts - 1350 kgm/min	200 watts - 1200 kgm/min	175 watts - 1050 kgm/min	200 watts - 1200 kgm/min	175 watts - 1050 kgm/min	150 watts - 900 kgm/min	175 watts - 1050 kgm/min	150 watts - 900 kgm/min	125 watts - 750 kgm/min

Workload chart for female or de-conditioned male

		1st Stage	25W 150 kgm/min	
Heart Rate	HR<80	HR: 80-90	HR: 90-100	HR>100
2nd Stage	125W 750 kgm/min	100W 600 kgm/min	75W 450 kgm/min	50W 300 kgm/min
3rd Stage	150W 900 kgm/min	125W 750 kgm/min	100W 600 kgm/min	75W 450 kgm/min
4th Stage	175W 1050 kgm/min	150W 900 kgm/min	117W 700 kgm/min	100W 600 kgm/min

Before the test:

- Make sure you are in good health; check with your physician before performing any exercise if you are over the age of 35 or persons with pre-existing health conditions.
- Adjust the seat to the proper position so that when your leg is extended during pedaling there is a slight bend at the knee of about 5 degrees.
- Make sure you have warmed up and stretched before taking the test.
- Do not take in caffeine before the test.
- Hold the hand grips gently, do not tense up.

Fitness test programming:

Press the Fitness-test button and press ENTER.

1. The message window will ask you to enter your gender. You may adjust the Age and Weight setting by using numeric keypads.
2. Now press START to begin the test.

During the test:

- The console must be receiving a steady heart rate for the test to begin. You may use the hand pulse sensors or wear a heart rate chest strap transmitter.
- You must maintain a steady 50 RPM pedal speed. If your pedal speed drops below 48 RPM or goes above 52 RPM the console will emit a steady beeping sound until you are within this range.
- You may through the various data readings in the message window by pressing the change under the message window.
 1. The message window will always display your pedal speed on the right side to help you maintain 50RPM.
 2. The data shown during the test is:
 - a. Work in KGM is actually an abbreviated form of kg-m/min. which is a work measurement of kilogram-force meter/minute
 - b. Work in Watts (1 watt is equal to 6.11829727787 kg-m/min.)
 - c. HR is your actual heart rate; TGT is the target heart rate to reach to end the test.
 - d. Time is the total elapsed time of the test.

After the test:

- Cool down for about one to three minutes.
- Take note of your score because the console will automatically return to the start-up mode after a few minutes.

What your score means:

VO2max Chart for males and very fit females

	18-25 years old	26-35 years old	36-45 years old	46-55 years old	56-65 years old	65+ years old
excellent	>60	>56	>51	>45	>41	>37
good	52-60	49-56	43-51	39-45	36-41	33-37
above average	47-51	43-48	39-42	35-38	32-35	29-32
average	42-46	40-42	35-38	32-35	30-31	26-28
below average	37-41	35-39	31-34	29-31	26-29	22-25
poor	30-36	30-34	26-30	25-28	22-25	20-21
very poor	<30	<30	<26	<25	<22	<20

VO2max Chart for females and de-conditioned males

	18-25 years old	26-35 years old	36-45 years old	46-55 years old	56-65 years old	65+ years old
excellent	56	52	45	40	37	32
good	47-56	45-52	38-45	34-40	32-37	28-32
above average	42-46	39-44	34-37	31-33	28-31	25-27
average	38-41	35-38	31-33	28-30	25-27	22-24
below average	33-37	31-34	27-30	25-27	22-24	19-22
poor	28-32	26-30	22-26	20-24	18-21	17-18
very poor	<28	<26	<22	<20	<18	<17

HEART RATE

A word about Heart Rate:

The old motto, “no pain, no gain”, is a myth that has been overpowered by the benefits of exercising comfortably. A great deal of this success has been promoted by the use of heart rate monitors. With the proper use of a heart rate monitor, many people find that their usual choice of exercise intensity was either too high or too low and exercise is much more enjoyable by maintaining their heart rate in the desired benefit range.

To determine the benefit range in which you wish to train, you must first determine your Maximum Heart Rate. This can be accomplished by using the following formula: 220 minus your age. This will give you the Maximum heart rate (MHR) for someone of your age. To determine the effective heart rate range for specific goals you simply calculate a percentage your MHR. Your Heart rate training zone is 50% to 90% of your maximum heart rate. 60% of your MHR is the zone that burns fat while 80% is for strengthening the cardio vascular system. This 60% to 80% is the zone to stay in for maximum benefit.

For someone who is 40 years old their target heart rate zone is calculated:

$220 - 40 = 180$ (maximum heart rate)
 $180 \times .6 = 108$ beats per minute (60% of maximum)
 $180 \times .8 = 144$ beats per minute (80% of maximum)

So for a 40 year old the training zone would be 108 to 144 beats per minute.

If you enter your age during programming the console will perform this calculation automatically. Entering your age is used for the Heart Rate control programs. After calculating your Maximum Heart Rate you can decide upon which goal you would like to pursue.

The two most popular reasons for, or goals, of exercise are cardiovascular fitness (training for the heart and lungs) and weight control. The black columns on the chart above represent the Maximum Heart Rate for a person whose age is listed at the bottom of each column. The training heart rate, for either cardiovascular fitness or weight loss, is represented by two different lines that cut diagonally through the chart. A definition of the lines' goal is in the bottom left-hand corner of the chart. If your goal is cardiovascular fitness or if it is weight loss, it can be achieved by training at 80% or 60%, respectively, of your Maximum Heart Rate on a schedule approved by your physician. Consult your physician before participating in any exercise program.

WARNING: Heart rate monitoring system may be inaccurate. Over exercise may result in injury or death. If you feel faint stop exercising immediately.

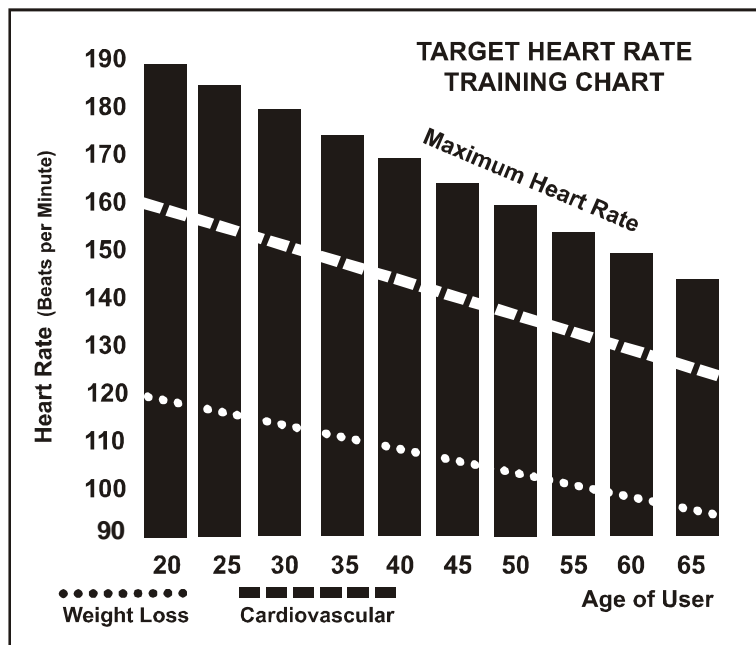

RATE OF PERCEIVED EXERTION

Heart rate is important but listening to your body also has a lot of advantages. There are more variables involved in how hard you should workout than just heart rate. Your stress level, physical health, emotional health, temperature, humidity, the time of day, the last time you ate and what you ate, all contribute to the intensity at which you should workout. If you listen to your body, it will tell you all of these things.

The rate of perceived exertion (RPE), also known as the Borg scale, was developed by Swedish physiologist G.A.V. Borg. This scale rates exercise intensity from 6 to 20 depending upon how you feel or the perception of your effort.

The scale is as follows:

Rating Perception of Effort

- 6 Minimal
- 7 Very, very light
- 8 Very, very light +
- 9 Very light
- 10 Very light +
- 11 Fairly light
- 12 Comfortable
- 13 Somewhat hard
- 14 Somewhat hard +
- 15 Hard
- 16 Hard +
- 17 Very hard
- 18 Very hard +
- 19 Very, very hard
- 20 Maximal

You can get an approximate heart rate level for each rating by simply adding a zero to each rating. For example, a rating of 12 will result in an approximate heart rate of 120 beats per minute. Your RPE will vary depending up the factors discussed earlier. That is the major benefit of this type of training. If your body is strong and rested, you will feel strong and your pace will feel easier. When your body is in this condition, you are able to train harder and the RPE will support this. If you are feeling tired and sluggish, it is because your body needs a break. In this condition, your pace will feel harder. Again, this will show up in your RPE and you will train at the proper level for that day.

USING A HEART RATE TRANSMITTER (optional)

How to wear your wireless chest strap transmitter:

1. Attach the transmitter to the elastic strap using the locking parts.
2. Adjust the strap as tightly as possible as long as the strap is not too tight to remain comfortable.
3. Position the transmitter with the logo centered in the middle of your body facing away from your chest (some people must position the transmitter slightly left of center). Attach the final end of the elastic strap by inserting the round end and, using the locking parts, secure the transmitter and strap around your chest.
4. Position the transmitter immediately below the pectoral muscles.
5. Sweat is the best conductor to measure very minute heart beat electrical signals. However, plain water can also be used to pre-wet the electrodes (2 ribbed oval areas on the reverse side of the belt and both sides of the transmitter). It's also recommended that you wear the transmitter strap a few minutes before your work out. Some users, because of body chemistry, have a more difficult time in achieving a strong, steady signal at the beginning. After "warming up", this problem lessens. As noted, wearing clothing over the transmitter/strap doesn't affect performance.
6. Your workout must be within range - distance between transmitter/receiver – to achieve a strong steady signal. The length of range may vary somewhat but generally stay close enough to the console to maintain good, strong, reliable readings. Wearing the transmitter immediately against bare skin assures you of proper operation. If you wish, you may wear the transmitter over a shirt. To do so, moisten the areas of the shirt that the electrodes will rest upon.

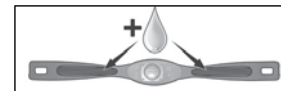
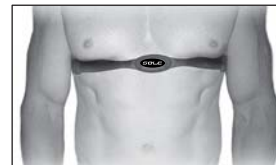

Note: The transmitter is automatically activated when it detects activity from the user's heart. Additionally, it automatically deactivates when it does not receive any activity. Although the transmitter is water resistant, moisture can have the effect of creating false signals, so you should take precautions to completely dry the transmitter after use to prolong battery life (estimated transmitter battery life is 2500 hours). The replacement battery is Panasonic CR2032.

ERRATIC OPERATION

Caution! Do not use this bike for Heart Rate Control unless a steady, solid Actual Heart Rate value is being displayed. High, wild, random numbers being displayed indicate a problem.

Areas to look at for interference, which may cause erratic heart rate:

1. Microwave ovens, TV's, small appliances, etc.
2. Fluorescent lights.
3. Some security systems.
4. Perimeter fence for a pet.
5. Some people have problems with the transmitter picking up a signal from their skin. If you have problems, try wearing the transmitter upside down. Normally the transmitter will be oriented, so the logo is right side up.
6. The antenna that picks up your heart rate is very sensitive. If there is an outside noise source, turning the whole machine 90 degrees may de-tune the interference.
7. Another Individual wearing a transmitter within 3' of your machine's console.

If you continue to experience problems, contact Dyaco Canada Inc.

HEART RATE CONTROL PROGRAM OPERATION

To start the HR program follow the instructions below or just press the HR key then the Enter button and follow the directions in the message window (Wear heart rate chest strap for more accurate result).

1. Press the HR key then press the Enter key.
2. The touch window will ask you to enter your Time. You may use numeric keypads to adjust the time, after press ENTER confirm and continue.
3. The touch window will ask you to enter your Age. You may use numeric keypads to adjust the Age, after press ENTER confirm and continue.
4. The touch window will ask you to enter your Weight. You may use numeric keypads to adjust the Weight, after press ENTER confirm and continue.
5. The touch window will ask you to enter your Target HR (65%). You may use numeric keypads to adjust the Target HR (65%), after press ENTER confirm and continue. (Default HR is 124. Range=60 to 200)
6. Now you are finished editing the settings and can begin your workout by pressing the Start key.
7. If you want to increase or decrease the workload at any time during the program press the Up or Down key. This will allow you to change your target heart rate at any time during the program.

CONSTANT POWER PROGRAM:

A Watts program is a controllable constant power whose Level adjusts when the speed is changed. To start the Constant Power program follow the instructions below or just press the Constant Power key, then the Enter button and follow the directions in the Message Window.

1. Press the Constant Power key, then press the Enter key.
2. The touch window will ask you to enter your Time. You may use numeric keypads to adjust the time, after press ENTER confirm and continue.
3. The touch window will ask you to enter your Age. You may use numeric keypads to adjust the Age, after press ENTER confirm and continue.
4. The touch window will ask you to enter your Weight. You may use numeric keypads to adjust the Weight, after press ENTER confirm and continue.
5. The touch window will ask you to enter your Target Watts. You may use numeric keypads to adjust the Target Watts, after press ENTER confirm and continue. (Default Target Watts is 50. Range=50 to 200)
6. Now you are finished editing the settings and can begin your workout by pressing the Start key.
7. If you want to increase or decrease the workload at any time during the program, press the Up/Down key. This will allow you to change your target Watt level at any time during the program.
8. When the program ends, you may press Start to begin the same program again or Stop to exit the program.

GENERAL MAINTENANCE

1. Wipe down all areas in the sweat path with a damp cloth after each workout.
2. If a squeak, thump, clicking or rough feeling develops the main cause is most likely one of two reasons:
 - 1) The hardware was not sufficiently tightened during assembly. All bolts that were installed during assembly need to be tightened as much as possible. It may be necessary to use a larger wrench than the one provided if you cannot tighten the bolts sufficiently. I cannot stress this point enough; 90% of calls to the service department for noise issues can be traced to loose hardware.
 - 2) The crank arm nut and/or the pedals need to be retightened.
3. If squeaks or other noises persist, check that the unit is properly leveled. There are 2 leveling pads on the bottom of the rear stabilizer, use a 14mm wrench (or adjustable wrench) to adjust the levelers.

Cleaning

Almost all surfaces are washable. A damp cloth is sufficient to clean most surfaces of this unit. Be careful not to drip water on the monitor. A mild liquid soap may be added if needed.

SYSTEM MAINTENANCE SUITE

Press the “Home” icon 10 consecutive repetitions to enter the Maintenance suite.

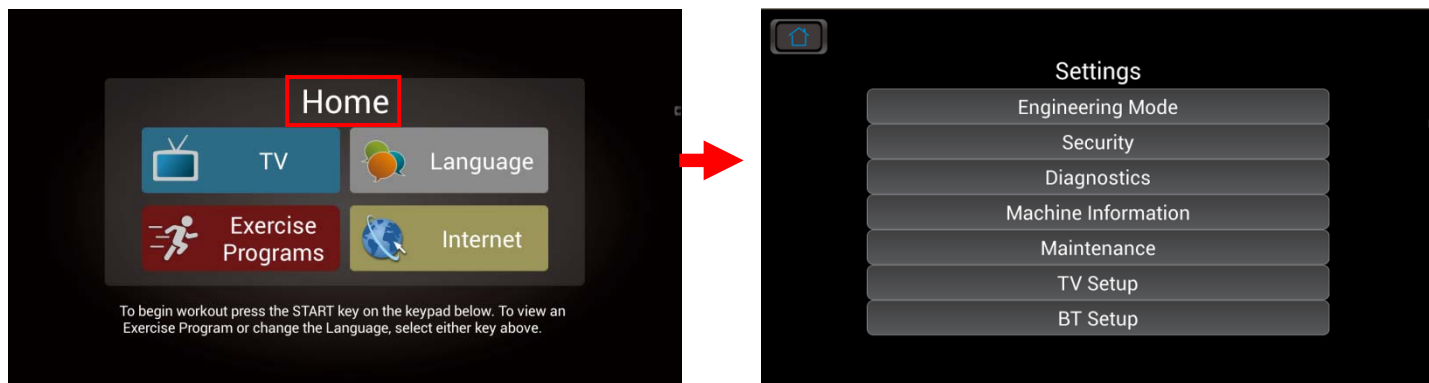

The two most commonly used menus for setting up the exercise machine are described below; the TV Setup and Maintenance menus. For information on other sections of the Maintenance suite refer to the technical service manual or call Spirit service.

TV Setup

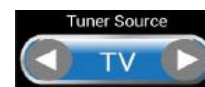
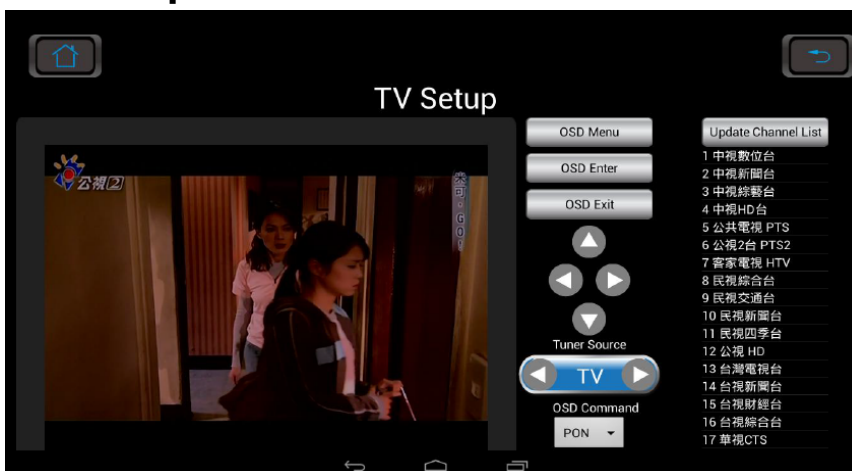

1. Begin by selecting either TV or HDMI as the tuner source.
2. If TV is chosen press ‘OSD Menu’. The first highlighted item on the menu is ‘Air/Cable’ and then ‘Cable’ or ‘Air’ afterward (Air = TV signals broadcasted over the air instead of a cable). Press the ‘OSD Enter’ to change the selection between Cable and Air Signal source, usually Cable).
3. After selecting Cable or Air use the arrows located below the ‘OSD Exit’ key to navigate down to ‘Auto Scan’ then press ‘OSD Enter’. The tuner will now scan for all available channels. Press ‘OSD Exit’ when done. You can modify the channels by pressing the ‘Update Channel List’.
4. The ‘OSD Command’ button is for engineering use only.

Maintenance Menu

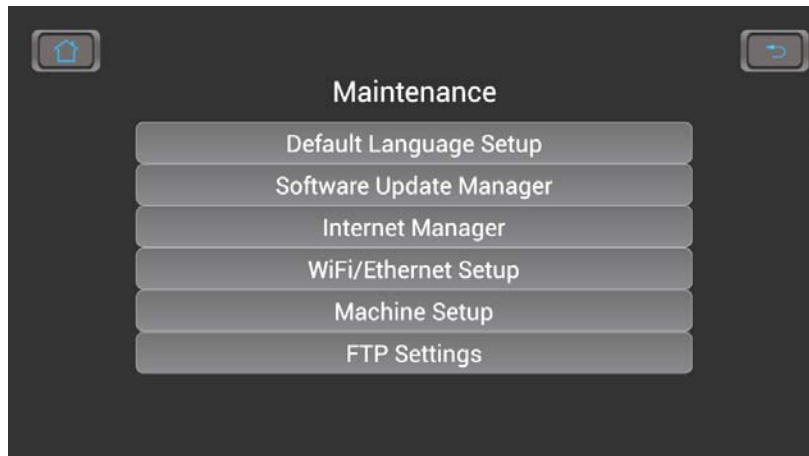

- The **Default language setup** allows you to select the main language that will be shown when the console is turned on. You are able to select the language in the Home menu, but once the user finishes using the machine the console will return to this default language.
- **Software update manager** is used to install new versions of the application software.
- **Internet manager** allows you to modify the internet sites that are shown in the Internet menu.
- **Wifi / Ethernet setup** is for selecting a Wifi signal or Ethernet addresses.
- **Machine Setup** Allows you to select whether the Csafe port is used for Csafe or CAB TV Tuner. This menu also allows you to set the screen brightness.
- **FTP Settings** is the Spirit FTP site address where Error logs and remote troubleshooting can be managed.

Internet Manager

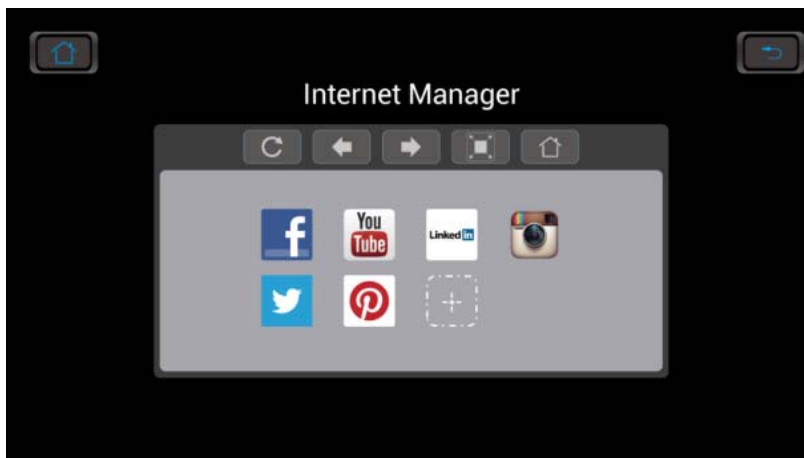

- Remove a link by pressing the icon of the site you want to remove for 2 seconds. A pop-up window will ask you to confirm the removal.
- To add a website, press the dotted outline box. A pop-up window will ask you to enter the web address and upload a picture for the final button if you wish. You could also just use a default-look button and type in the name of the site, which will then be the button icon.

Wifi /Ethernet Setup



- Press the desired button for setting up Wifi or Ethernet.

Wifi Setup

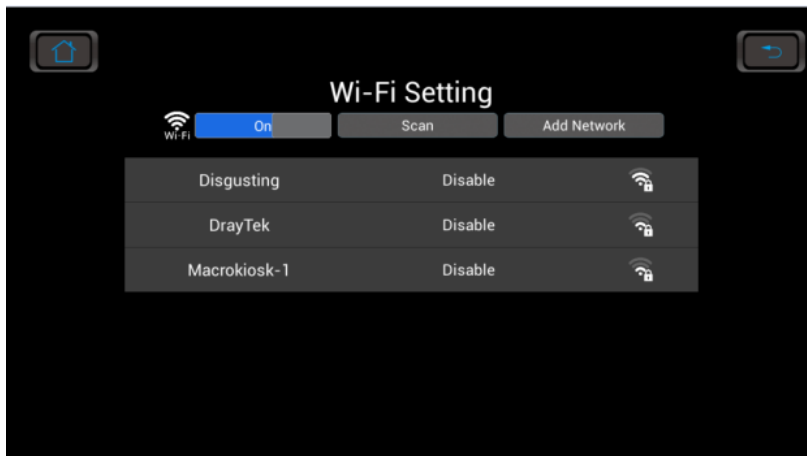

- Turn Wifi on and press scan for available Wifi connections. Press desired connection and follow the on-screen directions.

Ethernet Setup

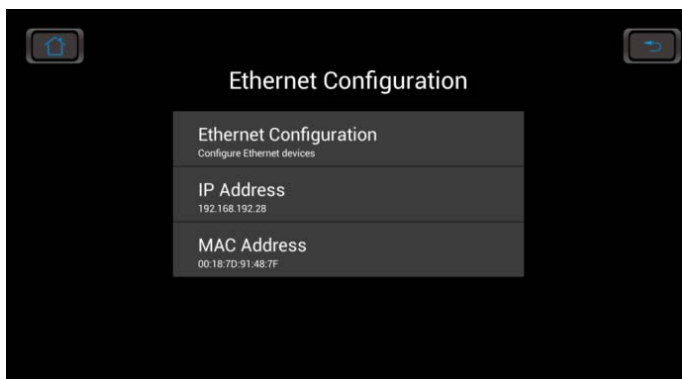

- Press Ethernet Configuration to set up connection.

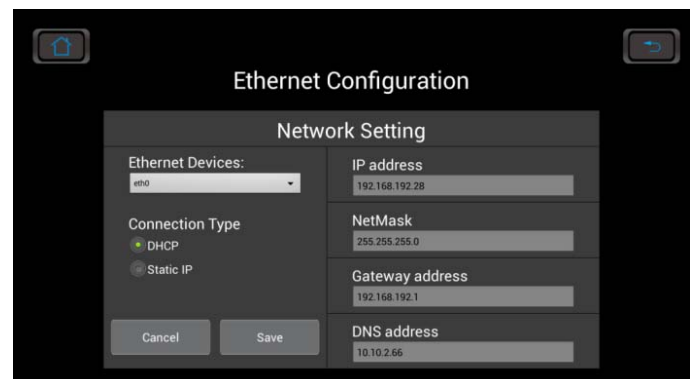

- Select DHCP to search for connection or a new

EXPLODED VIEW DIAGRAM

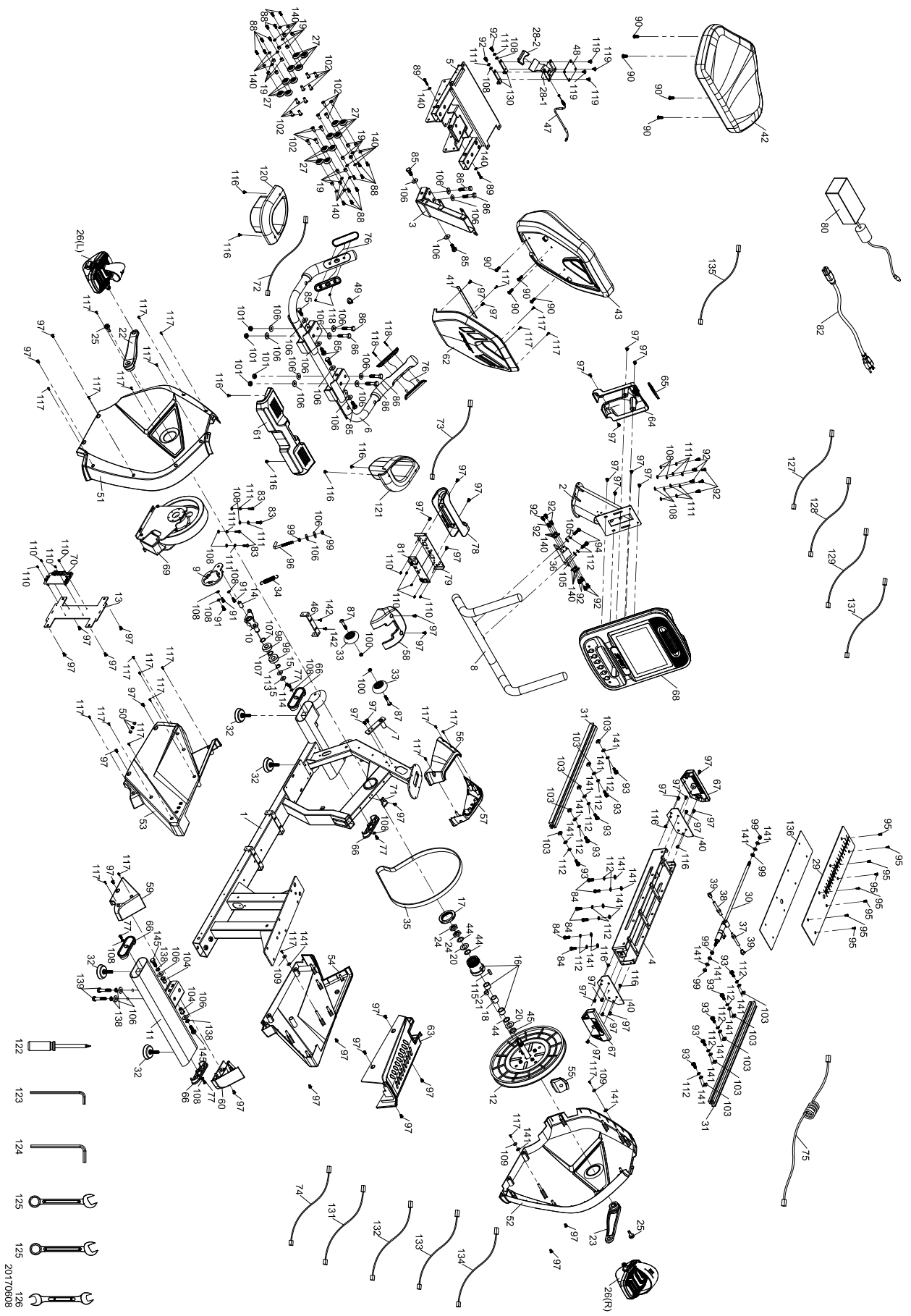

- 122
- 123
- 124
- 125
- 125
- 20170608
- 126

PARTS LIST

KEY NO	PART NO	DESCRIPTION	Q'TY
1	7890001E	Main Frame	1
2	7890002E	Console Mast	1
3	7890003E	Seat Back Frame	1
4	7890004E	Rail Assembly	1
5	7890005E	Seat Carriage Frame	1
6	7890006E	Rear Handlebar	1
7	7890007E	Back-up Lever	1
8	7890008E	Front Handlebar	1
9	7890009E	Idler Bracket	1
10	7890010E	Idler Wheel Assembly (Top)	1
11	7890011E	Rear Stabilizer	1
12	7890012E	Drive Pulley	1
13	7890013E	Lower Controller Plate	1
14	7890014E	Power metallurgy Sleeve	1
15	7890015E	Ø10 x Ø25 x 0.8T_Nylon Washer	2
16	7890016E	Bearing Bracket	1
17	7890017E	M50 x P1.5 x 11T_Nut	1
18	7890018E	Ring	1
19	7890019E	Core	16
20	7890020E	Plate	2
21	7890021E	Ø15 x 7T_Magnet	1
22	7890022E	Crank Arm(L)	1
23	7890023E	Crank Arm(R)	1
24	7890024E	M20 x P1.0 x 6T_Nut	2
25	7890025E	M8 x P1.0 x 25L_Arbor Screw	2
26	7890026E	Pedal (L,R)	1
27	7890027E	PU Wheel	16
28~01	7890028-01E	Seat Release Lever	1
28~02	7890028-02E	Nylon Handgrip	1
29	7890029E	Iron Board	1
30	7890030E	Shaft	1
31	7890031E	Seat Front Read Adjusting	2
32	7890032E	Adjustment Foot	4
33	7890033E	Ø65_Transportation Wheel	2
34	7890034E	Tension Spring, Idler Assembly	1
35	7890035E	Drive Belt	1
36	7890036E	Seat Stop Axle	1

KEY NO	PART NO	DESCRIPTION	Q'TY
37	7890037E	Axle (Ø8.5 x 69.5L)	1
38	7890038E	Axle (Ø8.5 x 73.5L)	1
39	7890039E	Sleeve	2
40	7890040E	Stopper Plate	2
41	7890041E	Seat Cover Retaining Bracket	1
42	7890042E	Seat Cushion	1
43	7890043E	Seat Back	1
44	7890044E	Back Plate	3
45	7890045E	Axle Back Plate	1
46	7890046E	Chain Cover Attaching Plate	1
47	7890047E	Steel Cable	1
48	7890048E	Handle Bar Back Plate	1
49	7890049E	Ø7_HGP Wire Grommet	1
50	7890050E	Block	3
51	7890051E	Front Shroud (L)	1
52	7890052E	Front Shroud (R)	1
53	7890053E	Rear Shroud (L)	1
54	7890054E	Rear Shroud (R)	1
55	7890055E	Off Switch Bracket	1
56	7890056E	Console Mast Cover-L	1
57	7890057E	Console Mast Cover-R	1
58	7890058E	Front Stabilizer Cover	1
59	7890059E	Rear Stabilizer Cover (L)	1
60	7890060E	Rear Stabilizer Cover (R)	1
61	7890061E	Rear Handlebar Cover	1
62	7890062E	Seat Back Cover	1
63	7890063E	Beam Cover	1
64	7890064E	Console Bracket Cover	1
65	7890065E	End Cap	1
66	7890066E	Cap	4
67	7890067E	Aluminum Axle End Cap	2
68	7890068E	Console Assembly	1
69	7890069E	Generator/Resistance	1
70	7890070E	Generator/Brake Controller	1
71	7890071E	1500m/m_Sensor W/Cable	1
72	7890072E	680m/m_Handpulse Wire(SMP3)	1
73	7890073E	800m/m_Handpulse Wire(SMR4)	1
74	7890074E	2400m/m_Handpulse Wire	1
75	7890075E	500m/m_Handpulse Wire	1

KEY NO	PART NO	DESCRIPTION	Q'TY
76	7890076E	30m/m_Handpulse W/Cable Assembly	2
77	7890077E	M5 x 15L_Phillips Head Screw	4
78	7890078E	TVC Cover	1
79	7890079E	Bracket	1
80	7890080E	Power Adaptor	1
81	7890081E	combo board-HDMI/TV/CSAFE	1
82	7890082E	Power Cord (Optional)	1
83	7890083E	1/4" x UNC20 x 3/4" _Hex Head Bolt	4
84	7890084E	M8 x 20m/m_Hex Head Bolt	6
85	7890085E	M10 x P1.5 x 25L_Hex Head Bolt	6
86	7890086E	M10 x 50m/m_Hex Head Bolt	6
87	7890087E	5/16" x UNC18 x 1-3/4" _Button Head Socket Bolt	2
88	7890088E	M6 x 15m/m_Button Head Socket Bolt	16
89	7890089E	M6 x P1.0 x 30L_Button Head Socket Bolt	2
90	7890090E	M8 x 20m/m_Button Head Socket Bolt	8
91	7890091E	M5 x 15m/m_Socket Head Cap Bolt	3
92	7890092E	M6 x P1.0 x 12L_Socket Head Cap Bolt	16
93	7890093E	M8 x 20m/m_Socket Head Cap Bolt	10
94	7890094E	M8 x 25m/m_Socket Head Cap Bolt	2
95	7890095E	M5 x P0.8 x 12L_Flat Head Countersink Bolt	8
96	7890096E	M8 x 80m/m_J Bolt	1
97	7890097E	M5 x P0.8 x 12L_Phillips Head Screw	47
98	7890098E	6203_Bearing	2
99	7890099E	M8 x 6.3T_Nut	6
100	7890100E	5/16 x 6T_Nyloc Nut	2
101	7890101E	M10 x 8T_Nyloc Nut	4
102	7890102E	M6 x 19L_Nut	16
103	7890103E	M8 x 1.25 x 6.5T_Square Nut	10
104	7890104E	M10 x 1.5m/m_Hex Blind Nut	2
105	7890105E	Ø5/16" x Ø18 x 1.5T_Flat Washer	2
106	7890106E	Ø3/8" x Ø25 x 2.0T_Flat Washer	22
107	7890107E	Ø17 x Ø23.5 x 1.0T_Flat Washer	2
108	7890108E	Ø1/4" x 13 x 1.0T_Flat Washer	19
109	7890109E	Ø3/16" x Ø15 x 1.5T_Flat Washer	3
110	7890110E	M3 x 6m/m_Phillips Head Screw	9
111	7890111E	Ø1/4" _Split Washer	12
112	7890112E	Ø5/16" x 1.5T_Split Washer	18
113	7890113E	Ø17_C Ring	1

KEY NO	PART NO	DESCRIPTION	Q'TY
114	78900114E	Ø10_C Ring	1
115	78900115E	7 x 7 x 25m/m_Woodruff Key	1
116	78900116E	4 x 12m/m_Sheet Metal Screw	10
117	78900117E	3.5 x 12m/m_Sheet Metal Screw	26
118	78900118E	3 x 20m/m_Tapping Screw	4
119	78900119E	M6 x 10m/m_Thumb Head Socket Screw	4
120	78900120E	Drink Bottle Holder (L)	1
121	78900121E	Drink Bottle Holder (R)	1
122	78900122E	Phillips Head Screwdriver	1
123	78900123E	5 L Allen Wrench	1
124	78900124E	6 L Allen Wrench	1
125	78900125E	17m/m_Wrench	2
126	78900126E	13/15m/m_Wrench	1
127	78900127E	1250m/m_Network Connecting Cable	1
128	78900128E	1300m/m_Connecting Wire	1
129	78900129E	1300m/m_TV Signal Cable	1
130	78900130E	Handle Interface Board	2
131	78900131E	2300m/m_Computer Cable	1
132	78900132E	2300m/m_Power Cord	1
133	78900133E	1000m/m_Wire Brake Coil Harness (Red)	1
134	78900134E	1100m/m_Connecting Wire	1
135	78900135E	200m/m_DC Power Cord	1
136	78900136E	Nylon Board	1
137	78900137E	1250m/m_CSAFE W/Cable	1
138	78900138E	Ø10 x 1.5T_Split Washer	4
139	78900139E	M10 x P1.5 x 55L_Hex Head Bolt	2
140	78900140E	Ø1/4" x 13 x 1.0T_Flat Washer	26
141	78900141E	Ø5/16" x 16 x 1.5T_Flat Washer	23
142	78900142E	M5 x P0.8 x 12L_Tapping Screw	2
145	78900145E	M10 x P1.5 x 30L_Hex Head Bolt	2

TRAINING GUIDELINES

EXERCISE

Exercise is one of the most important factors in the overall health of an individual. Listed among its benefits are:

- Increased capacity for physical work (strength endurance)
- Increased cardiovascular (heart and arteries/veins) and respiratory efficiency
- Decreased risk of coronary heart disease
- Changes in body metabolism, e.g. losing weight
- Delaying the physiological effects of age
- Physiological effects, e.g. reduction in stress, increase in self-confidence, etc.

BASIC COMPONENTS OF PHYSICAL FITNESS

There are four all encompassing components of physical fitness and we need to briefly define each and clarify its role.

Strength is the capacity of a muscle to exert a force against resistance. Strength contributes to power and speed and is of great importance to a majority of sports people.

Muscular Endurance is the capacity to exert a force repeatedly over a period of time, e.g. it is the capacity of your legs to carry you 10 Km without stopping.

Flexibility is the range of motion about a joint. Improving flexibility involves the stretching of muscles and tendons to maintain or increase suppleness and provides increased resistance to muscle injury or soreness.

Cardio-Respiratory Endurance is the most essential component of physical fitness. It is the efficient functioning of the heart and lungs

AEROBIC FITNESS

The largest amount of oxygen that you can use per minute during exercise is called your maximum oxygen uptake (MVo₂). This is often referred to as your aerobic capacity.

The effort that you can exert over a prolonged period of time is limited by your ability to deliver oxygen to the working muscles. Regular vigorous exercise produces a training effect that can increase your aerobic capacity by as much as 20 to 30%. An increased MVO₂ indicates an increased ability of the heart to pump blood, of the lungs to ventilate oxygen and of the muscles to take up oxygen.

Anaerobic Training

This means “without oxygen” and is the output of energy when the oxygen supply is insufficient to meet the body’s long-term energy demands. (For example, 100 meter sprint).

The Training Threshold

This is the minimum level of exercise which is required to produce significant improvements in any physical fitness parameter.

Progression

As you become fitter, a higher intensity of exercise is required to create an overload and therefore provide continued improvement

Overload

This is where you exercise at a level above that which can be carried out comfortably. The intensity, duration and frequency of exercise should be above the training threshold and should be gradually increased as the body adapts to the increasing demands. As your fitness level improves, so the training threshold should be raised.

Working through your program and gradually increasing the overload factor is important.

Specificity

Different forms of exercise produce different results. The type of exercise that is carried out is specific both to the muscle groups being used and to the energy source involved.

There is little transfer of the effects of exercise, i.e. from strength training to cardiovascular fitness. That is why it is important to have an exercise program tailored to your specific needs.

Reversibility

If you stop exercising or do not do your program often enough, you will lose the benefits you have gained. Regular workouts are the key to success.

WARM UP

Every exercise program should start with a warm up where the body is prepared for the effort to come. It should be gentle and preferably use the muscles to be involved later.

Stretching should be included in both your warm up and cool down and should be performed after 3-5 minutes of low intensity aerobic activity or callisthenic type exercise.

Warm Down or Cool Down

This involves a gradual decrease in the intensity of the exercise session. Following exercise, a large supply of blood remains in the working muscles. If it is not returned promptly to the central circulation, pooling of blood may occur in the muscles

Heart Rate

As you exercise, so the rate at which your heart beat also increases. This is often used as a measure of the required intensity of exercise. You need to exercise hard enough to condition your circulatory system, and increase your pulse rate, but not enough to strain your heart.

Your initial level of fitness is important in developing an exercise program for you. If you are starting off, you can get a good training effect with a heart rate of 110-120 beats per minute (BPM). If you are fitter, you will need a higher threshold of stimulation.

To begin with, you should exercise at a level that elevates your heart rate to about 65 to 70% of your maximum. If you find this is too easy, you may want to increase it, but it is better to lean on the conservative side.

As a rule of thumb, the maximum heart rate is 220 minus your age. As you increase in age, so your heart, like other muscles, loses some of its efficiency. Some of its natural loss is won back as fitness improves.

The following table is a guide to those who are “starting fitness”.

Age	25	30	35	40	45	50	55	60	65
Target heart Rate 10 Second Count	23	22	22	21	20	19	19	18	18
Beats per Minute	138	132	132	126	120	114	114	108	108

Pulse Count

The pulse count (on your wrist or carotid artery in the neck, taken with two index fingers) is done for ten seconds, taken a few seconds after you stop exercising. This is for two reasons: (a) 10 seconds is long enough for accuracy, (b) the pulse count is to approximate your BPM rate at the time you are exercising. Since heart rate slows as you recover, a longer count isn't as accurate.

The target is not a magic number, but a general guide. If you're above average fitness, you may work quite comfortably a little above that suggested for your age group.

The following table is a guide to those who are keeping fit. Here we are working at about 80% of maximum.

Age	25	30	35	40	45	50	55	60	65
Target heart Rate 10 Second Count	26	26	25	24	23	22	22	21	20
Beats per Minute	156	156	150	144	138	132	132	126	120

Don't push yourself too hard to reach the figures on this table. It can be very uncomfortable if you overdo it. Let it happen naturally as you work through your program. Remember, the target is a guide, not a rule, a little above or below is just fine.

Two final comments:(1) don't be concerned with day to day variations in your pulse rate, being under pressure or not enough sleep can affect it;(2) your pulse rate is a guide, don't become a slave to it.

ENDURANCE CIRCUIT TRAINING

Cardiovascular endurance, muscle, strength, flexibility and coordination are all necessary for maximum fitness. The principle behind circuit training is to give a person all the essentials at one time by going through your exercise program moving as fast as possible between each exercise. This increases the heart rate and sustains it, which improves the fitness level. Do not introduce this circuit training effect until you have reached an advanced program stage.

Body Building

Is often used synonymously with strength training. The fundamental principal here is OVERLOAD. Here, the muscle works against greater loads than usual. This can be done by increasing the load you are working against.

Patronization

This is the term used to vary your exercise program for both physiological and psychological benefits. In your overall program, you should vary the workload, frequency and intensity. The body responds better to variety and so do you. In addition, when you feel yourself getting "stale", bring in periods of lighter exercise to allow the body to recuperate and restore its reserves. You will enjoy your program more and feel better for it.

Muscle Soreness

For the first week or so, this may be the only indication you have that you are on an exercise program. This, of course, does depend on your overall fitness level. A confirmation that you are on the correct program is a very slight soreness in most major muscle groups. This is quite normal and will disappear in a matter of days.

If you experience major discomfort, you may be on a program that is too advanced or you have increased your program too rapidly.

If you experience PAIN during or after exercise, your body is telling you something. Stop exercising and consult your doctor.

WHAT TO WEAR

Wear clothing that will not restrict your movement in any way while exercising. Clothes should be light enough to allow the body to cool. Excessive clothing that causes you to perspire more than you normally would while exercising, gives you no advantage. The extra weight you lose is body fluid and will be replaced with the next glass of water you drink. It is advisable to wear a pair of gym or running shoes or "sneakers".

Breathing During Exercise

Do not hold your breath while exercising. Breathe normally as much as possible. Remember, breathing involves the intake and distribution of oxygen, which feeds the working muscles.

Rest periods

Once you start your exercise program, you should continue through to the end. Do not break off halfway through and then restart at the same place later on without going through the warm-up stage again.

The rest period required between strength training exercises may vary from person to person. This will depend mostly on your level of fitness and the program you have chosen. Rest between exercises by all means, but do not allow this to exceed two minutes. Most people manage with half minute to one-minute rest periods.

STRETCHING

Stretching should be included in both your warm up and cool down and should be performed after 3-5 minutes of low intensity aerobic activity or callisthenic type exercise. Movements should be performed slowly and smoothly, with no bouncing or jerking. Move into the stretch until slight tension, not pain, is felt in the muscle and hold for 20-30 seconds. Breathing should be slow, rhythmical and under control, making sure never to hold your breath.

HEAD ROLLS

Rotate your head to the right for one count, feeling the stretch up the left side of your neck. Next rotate your head back for one count, stretching your chin to the ceiling and letting your mouth open. Rotate your head to the left for one count, and finally, drop your head to your chest for one count.

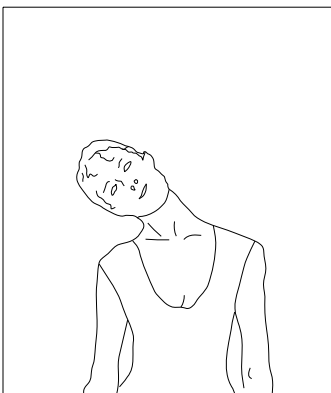

SHOULDER LIFTS

Lift your right shoulder up toward your ear for one count. Then lift your left shoulder up for one count as you lower your right shoulder.

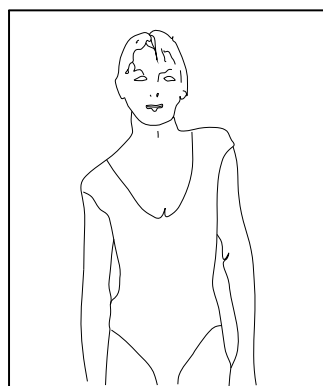

SIDE STRETCHES

Open your arms to the side and continue lifting them until they are over your head. Reach your right arm as far upward toward the ceiling as you can for one count. Feel the stretch up your right side. Repeat this action with your left arm.

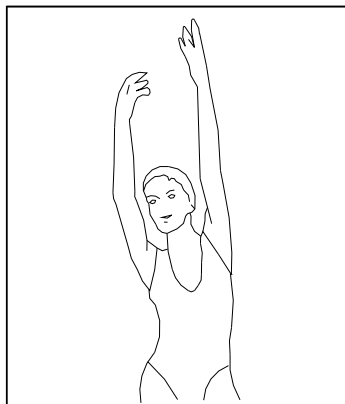

QUADRICEPS STRETCH

With one hand against a wall for balance, reach behind you and pull your right foot up. Bring your heel as close to your buttocks as possible. Hold for 15 counts and repeat with left foot up.

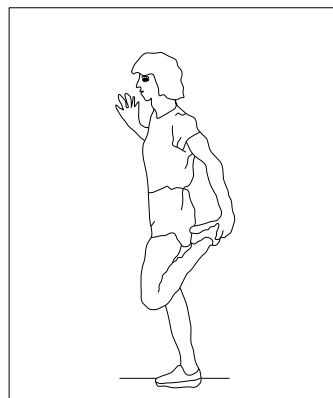

INNER THIGH STRETCH

Sit with the soles of your feet together with your knees pointing outward. Pull your feet as close into your groin as possible. Gently push your knees towards the floor. Hold for 15 counts.



TOUCHES

Slowly bend forward from your waist, letting your back and shoulders relax as you stretch toward your toes. Reach down as far as you can and hold for 15 counts.

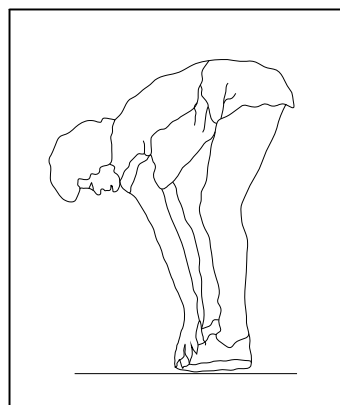

HAMSTRING STRETCHES

Sit with your right leg extended. Rest the sole of your left foot against your right inner thigh. Stretch as far as possible. Hold for 15 counts. Relax and then repeat with left leg extended.

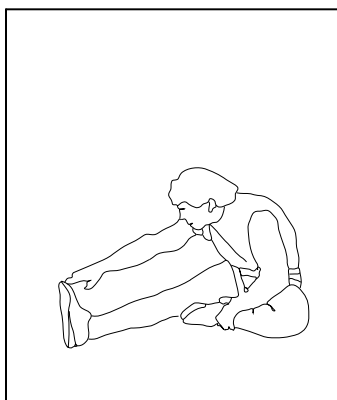

CALF / ACHILLES STRETCH

Lean against a wall with your left leg in front of the right and your arms forward. Keep toward your toe your right leg straight and the left foot on the floor then bend the left leg and lean forward by moving your hips toward the wall. Hold, then repeat on the other side for 15 counts.

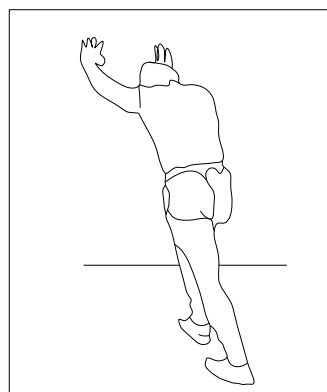

MANUFACTURER'S LIMITED WARRANTY

Dyaco Canada Inc. warrants all its bike parts for a period of time listed below, from the date of retail sale, as determined by a sales receipt. Dyaco Canada Inc.'s responsibilities include providing new or remanufactured parts, at Dyaco Canada Inc.'s option, and technical support to our independent dealers and servicing organizations. In the absence of a dealer or service organization, these warranties will be administered by Dyaco Canada Inc. directly to the facility. The warranty period applies to the following components:

Commercial Warranty (All Facilities)

Frame	Lifetime
Brake	5 Years
Parts	3 Years
Labour	3 Years

This warranty is not transferable and is extended only to the original owner.

NORMAL RESPONSIBILITIES OF THE FACILITY

The facility is responsible for the items listed below:

1. The warranty registration card must be completed and returned to the address listed on the card within 10 days of the original purchase.
2. Proper use of the bike in accordance with the instructions provided in this manual.
3. Proper installation in accordance with instructions provided with the bike and with all local electric codes.
4. Proper connection to a grounded power supply of sufficient voltage, replacement of blown fuses, repair of loose connections or defects in facility wiring.
5. Expenses for making the bike accessible for servicing, including any item that was not part of the bike at the time it was shipped from the factory.
6. Damages to the bike finish during shipping, installation or following installation.
7. Routine maintenance of this unit as specified in this manual.

EXCLUSIONS

This warranty does not cover the following:

1. CONSEQUENTIAL, COLLATERAL, OR INCIDENTAL DAMAGES SUCH AS PROPERTY DAMAGE AND INCIDENTAL EXPENSES RESULTING FROM ANY BREACH OF THIS WRITTEN OR ANY IMPLIED WARRANTY.
Note: Some areas do not allow the exclusion or limitation of incidental or consequential damages, so this limitation or exclusion may not apply to you.
2. Service call reimbursement to the facility. Service call reimbursement to the dealer that does not involve malfunction or defects in workmanship or material, for units that are beyond the warranty period, for units that are beyond the service call reimbursement period, for bike not requiring component replacement.
3. Damages caused by services performed by persons other than authorized Dyaco Canada Inc. service companies; use of parts other than original Dyaco Canada Inc. parts; or external causes such as corrosion, discoloration of paint or plastic, alterations, modifications, abuse, misuse, accident, improper maintenance, or acts of God.
4. Products with original serial numbers that have been removed or altered.
5. Products that have been: sold, transferred, bartered, or given to a third party.
6. Products that do not have a warranty registration card on file at Dyaco Canada Inc. Dyaco Canada Inc. reserves the right to request proof of purchase if no warranty record exists for the product.
7. THIS WARRANTY IS EXPRESSLY IN LIEU OF ALL OTHER WARRANTIES EXPRESSED OR IMPLIED, INCLUDING THE WARRANTIES OF MERCHANTABILITY AND/OR FITNESS FOR A PARTICULAR PURPOSE.
8. Warranties outside of Canada may vary. Please contact your local dealer or Dyaco Canada for details.

SERVICE

The sales receipt establishes the labour warranty period should service be required. If service is performed, it is in your best interest to obtain and keep all receipts. This written warranty gives you specific legal rights. Service under this warranty must be obtained by following these steps, in order:

1. Contact your selling authorized dealer or Dyaco Canada.
2. If you have any questions about your new product or questions about the warranty contact Dyaco Canada Inc. at 1-888-707-1880.
3. If no local service is available, Dyaco Canada Inc. will repair or replace the parts, at Dyaco Canada Inc.'s option, within the warranty period at no charge for parts. All transportation costs, both to our factory and upon return to the facility, are the responsibility of the facility. The facility is responsible for adequate packaging upon return to Dyaco Canada Inc. Dyaco Canada Inc. is not responsible for damages that occur during shipping. Make all freight damage claims with the appropriate freight carrier. DO NOT SHIP ANY UNIT TO OUR FACTORY WITHOUT A RETURN AUTHORIZATION NUMBER. All units arriving without a return authorization number will be refused.
4. For any further information, or to contact our service department by mail, send your correspondence to:

Dyaco Canada Inc.
5955 Don Murie Street
Niagara Falls, ON
L2G 0A9

Product features or specifications as described or illustrated are subject to change without notice. All warranties are made by Dyaco Canada Inc.



Please visit us online for information about our other brands and products manufactured and distributed by Dyaco Canada Inc.



www.dyaco.ca



www.dyaco.ca



www.dyaco.ca



www.dyaco.ca



www.spiritfitnesscanada.ca
www.dyaco.ca



www.spiritfitnesscanada.ca
www.dyaco.ca



www.solefitness.ca
www.dyaco.ca



www.trainorsports.ca
www.dyaco.ca



www.xterrafitness.ca
www.dyaco.ca