



SPIRIT

MEDICAL
SYSTEMS GROUP

A Heritage of Quality | The Spirit of Innovation



MR100 Rehabilitation Recumbent Bike USER'S MANUAL



PLEASE READ THIS ENTIRE MANUAL CAREFULLY BEFORE OPERATING YOUR
NEW LOWER BODY ERGOMETER AND SAVE IT FOR FUTURE USE.

Table of Contents

Product Registration.....	2
Important Safety Instructions.....	3
Important Electrical Information.....	4
Important Operation Instructions.....	4
Application Specification.....	5
Operating Principle.....	5
Significant Physical Characteristics.....	6
Significant Performance Characteristic.....	6
Intended User Profile.....	6
Operating The MR100.....	7
Features.....	8
Operation of Your New Bike.....	10
MR100 Assembly Instructions.....	23
MR100 Drawing & Parts List.....	33
Maintenance.....	40
Specifications.....	42
Description of Packaging Symbols.....	45
Manufacturer's Limited Warranty.....	46



Thank you for your recent purchase of this high quality lower body ergometer, the MR100, from Dyaco Canada Inc.

Your new product was manufactured by one of the leading fitness and medical products manufacturers in the world. Further, it is backed by one of the most comprehensive warranties in the industry. Through our dealers, distributors and manufacturer’s representatives, we will do all we can to provide many years of successful and prosperous ownership. Your warranty and service needs will be addressed collaboratively through your regional sales representative and our highly trained service technicians.

The responsibility of that collaborative team is to provide you with both the technical knowledge and access to service personnel to make your ownership experience more informed, and resolution of any difficulties easier to remedy.

Two components of the Spirit Medical Systems Group’s mission statement are “enhancing patient outcomes and improving effectiveness in the delivery of services”. This is just one of the many products that will assist you in providing that care to your patients and/or clients.

Please take a moment at this time to record the name of the dealer, distributor, or manufacturer’s representative, their telephone number, and the date of purchase below to make any future, needed contact easy. We appreciate your support and we will always remember that you are the reason that we are in business.

Please complete and mail your registration card today and enjoy your new MR100 ergometer.

Yours in Health and Wellness,
Dyaco Canada Inc

Product Registration

RECORD YOUR SERIAL NUMBER

Please record the Serial Number of this product in the space provided below. You can find the serial number on a sticker that is located on the front of the bike.

SN _____

Important Safety Instructions

- ⚠ **ATTENTION** - Read all instructions in this manual before using this device.
- ⚠ **DANGER** - To reduce the risk of electric shock disconnect your ergometer from the electrical outlet prior to cleaning and/or service work.
- ⚠ **WARNING**: Do not modify this equipment without authorization of the manufacturer.
- ⚠ **WARNING** - To reduce the risk of burns, fire, electric shock, or injury to persons, install the bike on a flat level surface with access to a 90 to 240-volt AC, 50/60 Hz, 15-amp grounded outlet. Do not use an extension cord unless it is 16awg or larger, with only one outlet on the end. The bike should be the only appliance in the electrical circuit. Do not attempt to disable the grounded plug by using improper adapters, or in any way modify the cord set; a serious shock or fire hazard may result along with computer malfunctions.
- Use this device only for its intended use as described in this manual.
- Keep children away from the bike. There are moving parts, obvious pinch points and other caution areas that can cause harm.
- Except as instructed for use of the device, keep hands away from all moving parts.
- Keep the electrical cord away from heated surfaces and out of all travel lanes and do not operate the bike if the cord or plug is damaged.
- Never drop or insert any object into any openings.
- Do not use outdoors.
- To disconnect, turn all controls to the off position then remove the plug from the outlet.
- This device is designed for commercial use and will meet the demands of orthopedic, sports wellness and general conditioning programs.
- Do not attempt to use your bike for any purpose other than for the purpose it is intended.
- The pulse sensors are not medical devices. Various factors, including the user's movement, may affect the accuracy of heart rate readings. The pulse sensors are intended only as exercise aids in determining heart rate trends in general.
- **WARNING**: Heart rate monitoring system may be inaccurate. Over exercise may result in injury or death. If you feel faint stop exercising immediately.
- Ensure there is a minimum space on the sides of the bike of two feet for proper operation, easy access and to prevent possible injuries to others standing or walking nearby. There should be a minimum of at least one foot of free space at the front and rear of the unit.
- Do not use any after market parts on this device, other than those recommended by Spirit.
- Do not attempt any servicing or adjustments other than those described in this manual. All else must be left to trained service personnel familiar with electro-mechanical equipment and authorized under the laws of the country in question to carry out maintenance and repair work.
- Installation and assembly of this product should be performed by trained personnel only.
- Hold the handlebar for support when getting on or off the bike.
- To avoid injury please observe all minimum and maximum seat adjustment settings.
- **Warning**: The adjustable crank arms may become entangled in pant legs if the pant legs are loose fitting. To avoid injury roll up the pant legs or secure the pant legs in some other fashion.
- The flywheel in the bike does not have a freewheel, but is directly connected to the pedals. The bike is equipped with auto-braking software that will stop the flywheel when it detects the user is trying to stop pedaling. In the unlikely event that the electronics fails, or the Auto-brake function is disabled in the software, a spinning flywheel can make the bike difficult to stop when pedaling at higher RPM. There is an emergency brake lever provided that will stop the flywheel when pressed.

Important Electrical Information

- ⚠ **NEVER** remove any cover without first disconnecting AC power. If voltage varies by ten percent (10%) or more, the performance of your bike may be affected. **Such conditions are not covered under your warranty.** If you suspect the voltage is low, contact your local power company or a licensed electrician for proper testing.
- ⚠ **NEVER** expose this bike to rain or moisture. This product is **NOT** designed for use outdoors, near a pool or spa, or in any other high humidity environment.
- ⚠ The MR100 is NOT protected against the ingress of water or particulate matter.
- ⚠ The MR100 is not suitable for use in an oxygen rich environment.
- ⚠ If not stated otherwise Spirit devices are designed for operation in normal climatic surroundings (IEC 60601-1):
 - Temperature: + 10° ... + 36° C
 - Relative humidity: 30 ... 90 % (non condensing)
 - Air pressure: 700 ... 1060 mbar
 - Maximum operating altitude: approx. 10,000 feet (3000m), without pressurization
 - Transport and store the devices at a temperature of – 20° ... + 50° C.

Grounding Instructions

This product must be grounded. In the unlikely event that the bike's electrical system should malfunction or breakdown grounding provides a path of least resistance for electric current, reducing the risk of electric shock. This product is equipped with a cord having an equipment-grounding plug. The plug must be plugged into an appropriate outlet that is properly installed and grounded in accordance with all local codes and ordinances.

- ⚠ **DANGER - Improper connection of the equipment-grounding conductor can result in a risk of electric shock. Check with a qualified electrician or serviceman if you are in doubt as to whether the product is properly grounded. Do not modify the plug provided with the product if it will not fit the outlet; have a proper outlet installed by a qualified electrician.**

Important Operation Instructions

- **NEVER** use your bike during an electrical storm. Surges may occur in your facility power supply that could damage the bike's components.
- **All users** should have medical clearance before starting any rigorous exercise program. This is especially important for persons with a history of heart disease or other high risk factors.
- **The user** should adjust the seat to a position that is comfortable during exercise. The console has a program in the Setup menu that can aid in setting the correct seat position.
- **Start** at a safe exercise level. Do not allow the user to be over exerted. Symptoms to watch for, but not limited to, are: Shortness of breath or difficulty in breathing, pain or discomfort, feeling faint.
- **Make sure** the user warms up and cools down properly to avoid over taxing the cardio vascular system. Allow three to five minutes of warm up and cool down during each exercise session.

Application Specification

Medical Purpose:

1. Patient warm up before physical therapy session
2. Have the patient pedal to improve range of motion after knee/hip/ankle surgery.
3. Allow patients to perform cardiovascular exercise

Intended Patient Population:

- There is no particular restriction on age, gender, height and nationality.
- Maximal patient's weight is 200kg.
- Patient must be ambulatory.
- Patient should have medical clearance before starting any rigorous exercise program. This is especially important for person with history of heart disease or other high risk factors.

Intended Part of the Body or Type of Tissue Applied to or Interacted with:

1. Contact site: Hands, feet, and trunk
2. Condition: Should not have any trauma

Intended Conditions of Use:

1. Environment including hygienic requirements:
 - (a) General: Intended for indoors use. This product is **NOT** designed for use outdoors, near a pool or spa, or in any other high humidity environment.
 - (b) Conditions of visibility:
 - Ambient luminance: Standard ambient room lighting is sufficient.
 - Viewing distance: 1 m
 - Viewing angle: 120°
 - (c) Physical:
 - Temperature range: 10°C ~36°C
 - Relative humidity range: 30% R.H. ~ 90% R.H., non condensing
 - (d) Hygienic requirements: There is no particular restriction on hygienic requirements.
2. Frequency of use: Dependant on therapist's plan.
3. Location: Intended for hospital use, clinic use, home use and research in academic institutions.
4. Mobility: The product is intended to be fixed.

Operating Principle

The patient pushes the pedals with their feet. The operator can increase the workload using the Up and Down Key on the console. When the workload change is requested an electromagnet is energized at field strengths relative to the workload requested. The magnetic field generated by the coil is induced into a flywheel creating Eddy currents to flow in the flywheel. The eddy currents then create an opposing magnetic field to the electromagnetic field creating more or less resistance at the pedal, determined by workload setting by the operator.

Significant Physical Characteristics

Please refer to **Features** of MR100 manual.

Significant Performance Characteristic

Please refer to “Unique uses for the Spirit ergometers” in **Operating The MR100** of MR100 manual.

Intended User Profile

Intended user:

1. Intended operator
 - There is no particular restriction on age, gender, height, weight, ability and culture.
 - Education: University or above
 - Knowledge: The operator should read the User’s Manual before use.
 - Discipline: The operator should receive training from the manufacturer before use.
 - Experience: The operator must have experience in physical therapy.
 - Background: The operator must be a major in physical therapy.
 - Professional competence: The operator should have the physical therapist license.

2. Intended Installer
 - There is no particular restriction on age, gender, height, weight, ability and culture.
 - Education: High School or above
 - Knowledge: The installer shall be able to manipulate this product properly.
 - Discipline: The installer shall be given a specific training by manufacturer.
 - Experience: The installer must have experience in product assembly and disassembly.
 - Background: The installer must be electro-mechanically trained.
 - Professional competence: Normal vision ability required.

Operating The MR100

The Spirit Medical Systems Group bike ergometers are intended to be used in aiding in the physical rehabilitation process for patients with orthopedic and neurological problems. Also used in sports medicine, wellness and general conditioning programs.

Typical applications for this type of product are:

1. Patient warm up before physical therapy session
2. Have the patient pedal to improve range of motion after knee/hip/ankle surgery.
3. Allow patients to perform cardiovascular exercise

Unique uses for the Spirit ergometer

1. Adjustable crank allows patients to pedal in smaller range of knee motion, from 15 degrees to full range.
2. Symmetry program measures balance between left and right pedal stroke. Graphical Bio-feedback display motivates patients to maintain even power symmetry between left and right legs.

Other features of the MR100:

- Work range up to 750 watts (60 rpm) when level settings are at 15 watts per level (see Setup under Console section for Level settings).
- Indexed seat positioning accommodates users from 147 cm to 200 cm (4' 10" to 6' 7")
- Heart Rate monitoring using the hand grips or optional heart rate chest-strap.

*Heart rate measurements are not for medical use:

“The heart rate function on this product is not a medical device. While heart rate grips or a thumb pulse sensor can provide a relative estimation of your actual heart rate, they should not be relied on when accurate readings are necessary. Some people, including those in a cardiac rehab program, may benefit from using an alternate heart rate monitoring system like a chest or wrist strap. Various factors, including movement of the user, may affect the accuracy of your heart rate reading. The heart rate reading is intended only as an exercise aid for measuring heart rate trends in general.”

Features



MR100 – Rehabilitation Ergometer



MA901 Neurological Pedals

Parts and Adjustments:

1. Electronic Console
2. Mechanical Brake
3. Pedal Adjustment
4. A.C. Power Input
5. Swivel Seat Release Bar
6. Hand Pulse Sensors
7. Seat Back Angle Adjustment
8. Leveling Glide

Optional Parts:

1. Neurological Pedal Set

The Spirit MR100 is an easy product to set up and use, from the adjustments to the intuitive interface. This section explains how to set up, adjust and operate your MR100 from Spirit Medical Systems Group.

Leveling the MR100:

- Once the MR100 is assembled, and placed on a flat level floor, it may be necessary to adjust the leveling glides on the bottom of the unit to ensure proper stability of the MR100. Use a 1/2" wrench to loosen the top nut of the leveler. Adjust the levelers by hand as necessary to remove any wobble in the unit. Then tighten the top nut against the bottom of the stabilizer tube. Make sure the bottom nut remains cinched against the leveling foot.

Connecting to A.C. Power:

- The MR100 has a built-in universal power supply. You can plug the MR100 into any A.C. power source from 90 to 240 volts, 50 to 60 Hz. The A.C. input is located in the front of the unit. The input module has an input connector for the line cord, a power switch and a 5 amp fuse. Turn the power switch to off when the MR100 is not in use.

Seat Adjustments

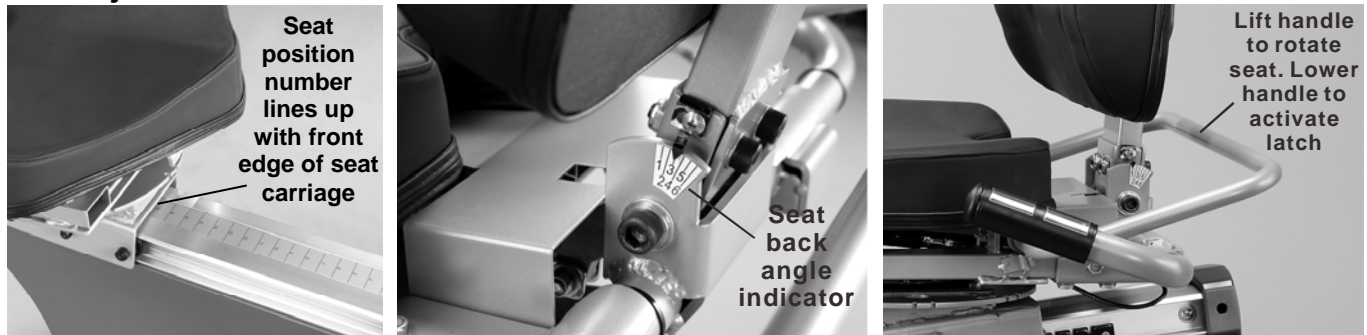

Adjusting the seat fore/aft position:

- Squeeze the brake handle located on the left side handle bar. Move the seat to the desired position and lower the handle. Move the seat slightly until the seat lock clicks in place. There is a numbered scale located on the aluminum seat slide tube for repeatable settings. Seat position is indicated by the front of the seat carriage lining up with the number on the scale.

Adjusting the seat back angle:

- The seat back angle can be adjusted for comfort, but also may be adjusted to change the hip angle for patients. To adjust the seat back angle, squeeze the brake handle located on the right side handle bar and move the seat back to the desired position. There is a numbered scale located just below the seat back cushion for repeatable settings.

Rotating the swivel seat:

- Lift the handle behind the seat to disengage the latch. Rotate the seat to the desired position; lower the handle when approaching position to activate latch. The seat will latch into place every 45 degrees

Pedal adjustment:

- Loosen the knob on the adjustable crank and pull up to disengage the pin. Slide the pedal up or down the crank arm to the desired setting then tighten the knob. There is a numbered scale for repeatability and a program in the Set Up function of the console that can assist in setting up the pedal position to accommodate various patient knee angles.
- **Warning:** Avoid wearing pants with loose fitting legs as they may get caught on the crank arm while pedaling.

Auto-Braking Feature:

- The MR100 has built-in sensing technology and software that will automatically stop the flywheel when it senses the user is attempting to stop pedaling. This Auto-braking software can be disabled during program set up before beginning a session. The Auto-Brake is set to off for the Symmetry and VO2 programs and can be turned on during program set up.

Mechanical Brake Lever Function:

- The brake's flywheel is also equipped with a mechanical brake that can be activated to stop the flywheel by pressing down on the lever.

MR100 Electronic Console:

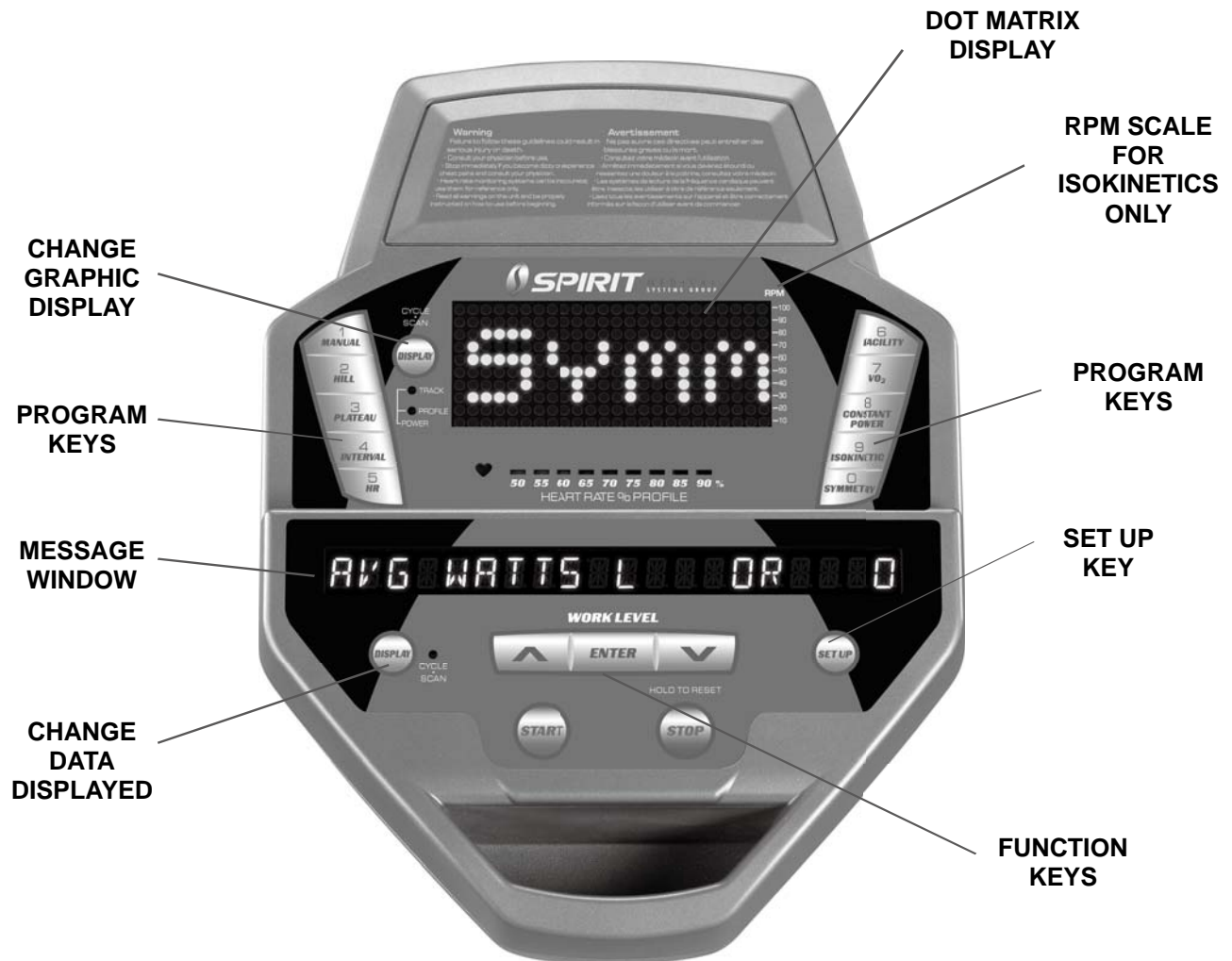

Power on

When initially powered on the console will perform an internal self-test. During this time all the lights will turn on for a short time. The dot matrix display will then show a software version (i.e. VER 1.0) and the message window will display an odometer reading. The odometer reading displays how many hours the bike has been used and how many virtual miles the bike has been ridden. The display will look like this: ODO 123 MI 123 HRS.

The odometer will remain displayed for only a few seconds then the console will go to the start up display, also known as Idle Mode. The dot matrix display will be scrolling through the different program profiles and the message window will be scrolling the start up message. You may now begin to use the MR100.

The console will automatically power down after 20 minutes of inactivity. Press any key to wake the console up again. Always turn off the main power switch when the MR100 is not in use.

Console Operation:

1. Set Up

The Set Up key function will allow you to enter patient data, set seat and pedal adjustments for various knee ranges of motion and customize the settings of the MR100. When the Set Up key is pressed the first option in the menu appears. Use the up/down arrows to scroll through the menu and press the enter key to select an option.

Set Up menu:

1. Patient Data:

- **Age:** used in Vo2 and heart rate programs.
- **Gender:** used in Vo2 program.
- **Weight:** used in METs and Calorie calculations and Vo2 program.
- **Height:** used in the seat position and pedal crank set up program.

2. Seat Position:

- User may input desired knee flexion angles (6 options) and the software will calculate the seat's fore/aft position and pedal position settings.
- This feature is intended to aid in patient set up but may not be the final settings as patient's body symmetry may vary slightly.
- This program uses the height from the Patient Data settings for limb length. The seat back angle position is assumed to be in the center of the adjustment range. The six knee angle options are:

- | | |
|---|--|
| 1. R Min (Right leg minimum flexion) | L Min (Left leg minimum flexion) |
| 2. R Max (Right leg maximum flexion) | L Max (Left leg maximum flexion) |
| 3. R Max (Right leg maximum flexion) | L Min (Left leg minimum flexion) |
| 4. R Min (Right leg minimum flexion) | L Max (Left leg maximum flexion) |
| 5. R Max (Right leg maximum flexion) | R Min (Right leg minimum flexion) |
| 6. L Max (Left leg maximum flexion) | L Min (Left leg minimum flexion) |

3. Watts Per Row:

- Adjusts the scale of the dot matrix when power (watts) is displayed. The default setting is 10 watts per row. The default of 10 watts per row means the full display (all 10 rows lit) equal 100 watts.
- The setting can be adjusted from 10 to 100 watts per row of lights on the graph.

4. Level Scale:

- Set the amount of change in the level adjustment of workload (resistance at the pedals) each time the arrow keys are pressed.
- This feature allows you to have very fine increments of resistance for physically challenged patients or set very high resistance levels for sports training. The default setting is; Fine, 5 watts per level. The three options are:

1. **Fine** – 5 watts per level (at 60 rpm)
2. **Medium** – 10 watts per level (at 60 rpm)
3. **Coarse** – 15 watts per level (at 60 rpm)

2. Quick Start

This is the quickest way to start an exercise session. After the console powers up you just press the Start key to begin; this will initiate the Quick Start mode. In Quick Start, the Time will count up from zero, all workout data will start to accrue and the workload may be adjusted manually by pressing the Up or Down key. The dot matrix will display a workload level at the lowest resistance. As you increase the workload more rows will light indicating a harder workout. The bike will get harder to pedal as the rows increase.

The dot matrix has 24 columns of lights and each column represents 1 minute in the Quick Start program (time per column can be modified in other programs). At the end of the 24th column (or 24 minutes of work) the display will wrap around and restart at the first column again. There are 50 levels of resistance displayed in 10 rows of LED lights. The amount of workload for each level can be modified in the Set Up menu.

3. Basic information

The **Dot Matrix Display** is used for displaying graphic feedback and has three basic displays for most programs, except for Isokinetic and Symmetry programs which are described later. When you begin a program the dot matrix will display a workload profile (constant resistance). To the left of the dot matrix there is a key labeled Display. Pressing this key will switch the display to show a Power graph (watt profile) and then a track. When both LEDs under the key are blinking the graph will scan through the three displays.

The **Message Window** is the main display for programming instructions and relevant measurements during a program. The measurement data shown varies depending on the program. Measurements include: Time and Segment Time, RPM, Pulse, Work level, Watts and Average Watts (Left and Right leg), METs, Calories and Symmetry.

Below the Dot matrix display is a **Heart Icon** and a **Bar Graph**. Simply grasping the hand pulse sensors, or wearing a heart rate chest belt transmitter, will start the Heart Icon blinking (this may take a few seconds). The Message Window will display your heart rate in beats per minute. The Bar Graph represents the percentage of maximum heart rate. NOTE: Enter the correct age in Set Up for the Bar Graph to be accurate. Refer to Heart Rate section for details about these features.

The **Stop/Reset** key provides several functions.

- Pressing the Stop/Reset key once during a program will **Pause** the program. To resume the exercise session just press the Start key or start pedaling.
- If the Stop/Reset button is pressed twice during a workout the program will end and a summary of information of the exercise session will be displayed.
- If the Stop/Reset key is held down for 3 seconds the console will perform a complete **Reset**.
- During data entry for a program the Stop/Reset key performs a **Previous Screen** function. This allows you to go back one step in the programming each time you press the Stop/Reset key.

The **Program Keys** may be used to preview each program when in the idle mode. Press each program key to preview what the program profile looks like. To begin a program press the corresponding program key and then press the Enter key to select the program.

The program keys also function as a **Number Key Pad** when you are in the data-setup mode. The number for each key is shown above the program name. If you are entering new data such as Time, Age, weight etc., you can use these keys to enter the numbers quickly.

4. Selecting and customizing programs

When you enter a program you have the option of modifying the settings. If you want to begin without entering new settings just press the Start key. This will bypass the programming of data and take you directly to the start of the program. If you want to change the settings just follow the instructions in the message window. If you start a program without changing the settings the data from the Set Up menu will be used.

Manual

The Manual program works as the name implies, manually. This means that you control the workload yourself, not the computer. To start the Manual program follow the instructions below or just press the Manual button then the Enter button and follow the directions in the message window.

1. Press the **Manual** key then press the **Enter** key.
2. The message window will prompt you to enter the time for the program. You may enter the time using the Up and Down keys or the numeric key pad then press the Enter key to accept and proceed to the next screen.
3. The next setting is for the **Auto-braking** feature. You may turn the auto-brake on or off then press enter to continue.
4. Now you are finished editing the settings and can begin the program by pressing the Start key. You can also go back and modify your settings by pressing the Enter key. NOTE: At any time during the editing of Data you can press the Stop key to go back one level, or screen.
5. During the Manual program you will be able to scroll through the data in the message window by pressing the **Display key**. You may also switch between the profile or power displays and a quarter mile track by pressing the Display key adjacent to the dot matrix display.
6. When the program ends you may press Start to begin the same program again or Stop to exit the program, or you can save the program you just completed as the **Facility** program by pressing the Facility key and following the instructions in the message window.

Preset Programs

The bike has three preset exercise programs that have been designed for a variety of workout goals. The initial built-in level of difficulty for each program is set to a relatively easy level. You may adjust the level of difficulty (Max level) for each program before beginning.

The profiles shown in the dot matrix are merely pictures of the whole profile and will not change in size when the work level keys are pressed. When setting up a program you will enter the maximum resistance setting for the peak of the profile. During the program the resistance levels will change as the profile progresses. When the up key is pressed to request more resistance the profile picture will not change, but the workload will increase. The message window will display the level setting for the current segment and also the maximum level for the peak of the profile. Pressing the work keys actually change the peak level of the program not the current segment level. You may need to change the peak setting several times before the current segment increases.

HILL

The **Hill** program simulates going up and down a hill. The resistance in the pedals will steadily increase and then decrease during the program.



PLATEAU

The **Plateau** program provides a steady state exercise with warm up and cool down periods.

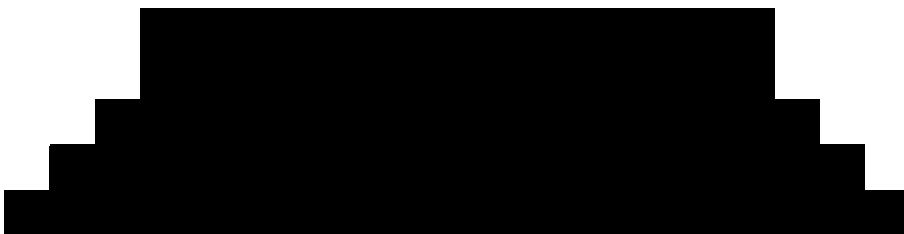

Interval

The **Interval** program takes you through high levels of intensity followed by periods of low intensity. This program increases your endurance by depleting your oxygen level followed by periods of recovery to replenish oxygen. Your cardio vascular system gets programmed to use oxygen more efficiently this way.



Programming Preset Programs:

1. Select the desired program button then press the **Enter** key.
2. The message window will prompt you to enter the time for the program. You may enter the time using the Up and Down keys or the numeric key pad then press the Enter key to accept and proceed to the next screen.
3. The next setting is for the **Auto-braking** feature. You may turn the auto-brake on or off then press enter to continue.
4. Now you are finished editing the settings and can begin the program by pressing the Start key. You can also go back and modify your settings by pressing the Enter key. NOTE: At any time during the editing of Data you can press the Stop key to go back one level, or screen.

5. During the Manual program you will be able to scroll through the data in the message window by pressing the **Display key**. You may also switch between the profile or power displays and a quarter mile track by pressing the Display key adjacent to the dot matrix display.
6. When the program ends you may press Start to begin the same program again or Stop to exit the program, or you can save the program you just completed as the **Facility** program by pressing the Facility key and following the instructions in the message window.

Facility Program

The Facility program allows you to build and save a custom program. You can build your own custom program by following the instructions below or you can save any other preset program you complete as a custom program. The Facility program allows you to further personalize it by adding your facility name.

Designing and saving a new program:

1. Press the **Facility** key. The message window will show a welcome message; if you had previously saved a program the message will contain the name you gave it. Then press the **Enter** key to begin programming.
2. When you press enter, the message window will show "Name – A", if there is no name saved. If the name "Custom Workout" had been previously saved the message window will show "Name – Custom Workout" and the C in Custom will be blinking. If there is a name saved you can change it or you may press the Stop key to keep the name and continue to the next step. If you want to enter a name use the Up and/or the Down key to change the first letter then press Enter to save the first letter and continue to the next letter. When you have finished entering the name press the Stop key to save the name and continue to the next step.
3. The message window will ask you to enter an **Age**. You may enter an Age, using the Up and Down keys or the numeric key pad, then press the Enter key to accept the new number and proceed on to the next screen.
4. You are now asked to enter a **Weight**. You may adjust the Weight number using the Up and Down keys or the numeric key pad then press enter to continue.
5. Next is **Time**. You may adjust the Time and press enter to continue.
6. Now you are asked to adjust the **Max Level**. This is the peak exertion level you will experience during the program. Adjust the level and then press enter.
7. Now the first column will be blinking and you are asked to adjust the level for the first segment of the workout. When you finish adjusting the first segment, or if you don't want to change, then press enter to continue to the next segment.
8. The next segment will show the same level as the previously adjusted segment. Repeat the same process as the last segment then press enter. Continue this process until all twenty four segments have been set.
9. The message window will then tell you to press enter to save the program. After saving the program the message window says "New program saved" then will give you the option to Start or modify the program. Pressing Stop will exit to the start up screen.
10. During the Facility program you will be able to scroll through the data in the message window by pressing the adjacent **Display** key.

Running a saved program:

1. Press Facility key then Enter
2. Enter Time then set Auto-brake on or off and press enter. Then press start to begin program.

Vo2 Test

The Vo2 program is based on the YMCA protocol and is a sub-maximal test that uses pre-determined, fixed work levels that are determined based on the heart rate readings measured as the test progresses. The test will take anywhere between 6 to 15 minutes to complete, depending on the fitness level of the user. The test ends when the user's heart rate reaches 85% of maximum at any time during the test, or the heart rate is between 110 bpm and 85% at the end of two consecutive stages. At the end of the test a VO_{2max} score will be displayed.

The YMCA protocol employs two to four stages, lasting 3 minutes each, of continuous exercise (see charts below). You will be prompted to choose either, Male or Female at the beginning of the test. This choice determines which protocol will be used during the test as shown in the charts below. The only caveat is if you are a very de-conditioned male you may need to choose option Female. If you are a very conditioned female you may need to choose option Male.

Workload chart for male or very fit female:

1st Stage				50 watts – 300 kgm/min					
HR		< 90			90 - 105			> 105	
2nd Stage		150 watts – 900 kgm/min			125 watts – 750 kgm/min			100 watts- 600 kgm/min	
HR	HR <120	HR 120-135	HR >135	HR <120	HR 120-135	HR >135	HR <120	HR 120-135	HR >135
3rd stage	225 watts - 1350 kgm/min	200 watts - 1200 kgm/min	175 watts - 1050 kgm/min	200 watts - 1200 kgm/min	175 watts - 1050 kgm/min	150 watts – 900 kgm/min	175 watts - 1050 kgm/min	150 watts – 900 kgm/min	125 watts- 750 kgm/min

Workload chart for female or de-conditioned male

		1st Stage	25W 150 kgm/min	
Heart Rate	HR<80	HR: 80-90	HR: 90-100	HR>100
2nd Stage	125W 750 kgm/min	100W 600 kgm/min	75W 450 kgm/min	50W 300 kgm/min
3rd Stage	150W 900 kgm/min	125W 750 kgm/min	100W 600 kgm/min	75W 450 kgm/min
4th Stage (if needed)	175W 1050 kgm/min	150W 900 kgm/min	117W 700 kgm/min	(100W 600 kgm/min

VO2 test programming:

1. Press the Vo2 button and press enter.
2. The message window will prompt you to enter your **Gender**. Use the Up and Down keys to change and press the Enter key to accept and proceed on to the next screen.
3. You are now prompted to enter your **Age**. You may adjust the age using the Up or Down key then press enter to continue.
4. You are now prompted to enter your **Weight**. You may adjust the weight using the Up or Down key then press enter to continue
5. Now press Start to begin the test.

Before the test:

- Make sure you are in good health; check with your physician before performing any exercise if you are over the age of 35 or persons with pre-existing health conditions.
- Adjust the seat to the proper position so that when your leg is extended during pedaling there is a slight bend at the knee of about 5 degrees.
- Make sure you have warmed up and stretched before taking the test.
- Do not take caffeine before the test.

During the test:

- The console must be receiving a steady heart rate for the test to begin. You may use the hand pulse sensors or wear a heart rate chest strap transmitter, although chest strap transmitter is recommended.
- The user must maintain a steady 50 RPM pedal speed. If the pedal speed drops below 48 RPM or goes above 52 RPM the console will emit a steady beeping sound and the RPM number will flash until the speed is within this range.
- You may scroll through the various data readings in the message window by pressing the Display button under the message window.
 1. The message window will always display your pedal speed on the right side to help you maintain 50RPM.
 2. The data shown during the test is:
 - a. **Work in KGM** is actually an abbreviated form of kg-m/min. which is a work measurement of kilogram-force meter/minute
 - b. **Work in Watts** (1 watt is equal to 6.11829727787 kg-m/min.)
 - c. **HR** is your actual heart rate; **TGT** is the target heart rate to reach to end the test.
 - d. **Time** is the total elapsed time of the test.

After the test:

- Cool down for about one to three minutes.
- Take note of the score because the console will automatically return to the start-up mode after a few minutes.

What the score means:

VO2max Chart for males and very fit females

	18-25 years old	26-35 years old	36-45 years old	46-55 years old	56-65 years old	65+ years old
excellent	>60	>56	>51	>45	>41	>37
good	52-60	49-56	43-51	39-45	36-41	33-37
above average	47-51	43-48	39-42	35-38	32-35	29-32
average	42-46	40-42	35-38	32-35	30-31	26-28
below average	37-41	35-39	31-34	29-31	26-29	22-25
poor	30-36	30-34	26-30	25-28	22-25	20-21
very poor	<30	<30	<26	<25	<22	<20

VO2max Chart for females and de-conditioned males

	18-25 years old	26-35 years old	36-45 years old	46-55 years old	56-65 years old	65+ years old
excellent	56	52	45	40	37	32
good	47-56	45-52	38-45	34-40	32-37	28-32
above average	42-46	39-44	34-37	31-33	28-31	25-27
average	38-41	35-38	31-33	28-30	25-27	22-24
below average	33-37	31-34	27-30	25-27	22-24	19-22
poor	28-32	26-30	22-26	20-24	18-21	17-18
very poor	<28	<26	<22	<20	<18	<17

Constant Power

The Constant Power program automatically controls the resistance level at the pedals, depending on user speed, to maintain a steady power workload.

1. Press the **Constant Power** key then press the Enter key.
2. The message window will prompt you to enter the **Time** for the program. You may enter the time using the Up and Down keys or the numeric key pad then press the Enter key to accept and proceed to the next screen.
3. Set the target **Watt Level** for the program then press Enter. The default setting is 50 watts.
4. You may turn the **Auto-brake** on or off then press enter to continue.
5. Now you are finished editing the settings and can begin your workout by pressing the Start key. You can also go back and modify your settings by pressing the Enter key.
NOTE: At any time during the editing of Data you can press the Stop key to go back one level, or screen.
6. During the program you will be able to scroll through the data in the message window by pressing the Display key. You may also switch between the power profile, resistance profile or a quarter mile track by pressing the Display key adjacent to the dot matrix display.
7. When the program ends you may press Start to begin the same program again or Stop to exit the program, or you can save the program you just completed as the **Facility** program by pressing the Facility key and following the instructions in the message window.

Isokinetic

The Isokinetic program provides accommodating resistance at a fixed speed level. The user controls the resistance at the pedals by pushing harder or lighter. The desired pedaling speed is entered and the computer increases the resistance automatically if the user tries to overcome the set speed.

1. Press the Isokinetic key then press the **Enter** key.
2. The message window will prompt you to enter the **Time** for the program. You may enter the time using the Up and Down keys or the numeric key pad then press the Enter key to accept and proceed to the next screen.
3. Set the target **RPM Level** for the program then press Enter. The default setting is 30 RPM.
4. You may turn the **Auto-brake** on or off then press enter to continue.
5. Now you are finished editing the settings and can begin your workout by pressing the Start key. You can also go back and modify your settings by pressing the Enter key.
NOTE: At any time during the editing of Data you can press the Stop key to go back one level, or screen.
6. During the program you will be able to scroll through the data in the message window by pressing the **Display key**. You may also switch between the speed profile, power profile or a quarter mile track by pressing the Display key adjacent to the dot matrix display. There is an RPM graph to the right of the dot matrix to monitor user speed.
7. When the program ends you may press Start to begin the same program again or Stop to exit the program, or you can save the program you just completed as the **Facility** program by pressing the Facility key and following the instructions in the message window.

Symmetry

The Symmetry program may aid in achieving a more balanced pedaling stroke for patients with lower limb deficiencies, such as stroke patients and post-op knee patients. The program will measure the left and right power around the pedal rotation and display the watt measurements in the message window. The Dot Matrix display will show a graph indicating the leg power symmetry so the user has a visual feedback to aid in improving the involved limb's strength.

1. Press the Symmetry key then press the **Enter** key.
2. The message window will prompt you to enter the **Time** for the program. You may enter the time using the Up and Down keys or the numeric key pad then press the Enter key to accept and proceed to the next screen.
3. You may turn the **Auto-brake** on or off then press enter to continue. Since the auto-brake may be activated with severe asymmetry the auto-brake default setting is off. If you want the auto-brake feature operational please set to on and press enter.
4. Now you are finished editing the settings and can begin by pressing the Start key. You can also go back and modify your settings by pressing the Enter key.

For Best Results:

The Symmetry program starts at level 1 and the resistance needs to be increased manually by pressing the Up arrow. Make sure to set the resistance to a level where the patient is doing enough work to generate a meaningful measurement. It is recommended to set the resistance as high as the patient can perform without discomfort, but low enough so they can complete full pedal revolutions. Very low resistance settings result in erratic or inconsistent measurements.

Biofeedback Measurements and Graph:

Below is a sample picture showing the symmetry graph. In the message window there is an average watt measurement and it is indicating that the left leg is producing more power than the right leg, 41 vs. 34 watts. The graph reflects the higher wattage of the left leg. If the power is equal in both legs only two dots would be lit on the bottom center of the graphic screen.

To view the Symmetry Index number press the Display key located under the message window. The Symmetry Index number is the percentage of difference between the left and right leg power. If the left and right legs are producing the same power the Symmetry Index will be 0%.



Note: The Symmetry program employs a proprietary algorithm using a power table and velocity calculations to generate the watt readings; they are not from direct force measurements.

Using a Heart Rate Transmitter

*NOTE: The chest strap transmitter is not a standard part, but is a separate purchase. A chest strap transmitter may be purchased from Spirit. Most transmitters that operate at 5kHz frequency will also work.

How to wear your wireless chest strap transmitter:

1. Attach the transmitter to the elastic strap using the locking parts.
2. Adjust the strap as tightly as possible as long as the strap is not too tight to remain comfortable.
3. Position the transmitter with the logo centered in the middle of your body facing away from your chest (some people must position the transmitter slightly left of center). Attach the final end of the elastic strap by inserting the round end and, using the locking parts, secure the transmitter and strap around your chest.
4. Position the transmitter immediately below the pectoral muscles.
5. Sweat is the best conductor to measure very minute heart beat electrical signals. However, plain water can also be used to pre-wet the electrodes (2 black square areas on the reverse side of the belt and either side of transmitter). It's also recommended that you wear the transmitter strap a few minutes before your work out. Some users, because of body chemistry, have a more difficult time in achieving a strong, steady signal at the beginning. After "warming up", this problem lessens. As noted, wearing clothing over the transmitter/strap doesn't affect performance.
6. Your workout must be within range - distance between transmitter/receiver – to achieve a strong steady signal. The length of range may vary somewhat but generally stay close enough to the console to maintain good, strong, reliable readings. Wearing the transmitter immediately against bare skin assures you of proper operation. If you wish, you may wear the transmitter over a shirt. To do so, moisten the areas of the shirt that the electrodes will rest upon.

Note: The transmitter is automatically activated when it detects activity from the user's heart. Additionally, it automatically deactivates when it does not receive any activity. Although the transmitter is water resistant, moisture can have the effect of creating false signals, so you should take precautions to completely dry the transmitter after use to prolong battery life (estimated transmitter battery life is 2500 hours). If your chest strap has a replaceable battery the replacement battery is Panasonic CR2032.

Erratic Operation:

Caution! Do not use this bike for Heart Rate Control unless a steady, solid Actual Heart Rate value is being displayed. High, wild, random numbers being displayed indicate a problem.

Areas to look at for interference, which may cause erratic heart rate:

- (1) Microwave ovens, TVs, small appliances, etc.
- (2) Fluorescent lights.
- (3) Some household security systems.
- (4) Perimeter fence for a pet.
- (5) Some people have problems with the transmitter picking up a signal from their skin. If you have problems try wearing the transmitter upside down. Normally the transmitter will be oriented so the Spirit logo is right side up.
- (6) The antenna that picks up your heart rate is very sensitive. If there is an outside noise source, turning the whole machine 90 degrees may de-tune the interference.
- (7) If there is another person wearing a chest strap within 1 meter, it will interfere.
- (8) *If you continue to experience problems contact your dealer.*

Heart Rate Program operation

To start the **HR** program follow the instructions below or just press the HR key then the Enter button and follow the directions in the message window.

1. Press the **HR** key then press the **Enter** key.
2. The message window will ask you to enter your **Age**. You may enter your Age, using the Up and Down keys or the numeric key pad, then press the Enter key to accept the new number and proceed on to the next screen.
3. You are now asked to enter your **Weight**. You may adjust the Weight number using the Up and Down keys or the numeric key pad, then press enter to continue.
4. Next is **Time**. You may adjust the Time and press enter to continue.
5. Now you are asked to adjust the **Heart rate Level**. This is the heart rate level you will experience during the program. Adjust the level and then press enter.
6. Now you are finished editing the settings and can begin your workout by pressing the Start key. You can also go back and modify your settings by pressing the Enter key. NOTE: At any time during the editing of Data you can press the Stop key to go back one level, or screen.
7. If you want to increase or decrease the workload at any time during the program press the Up or Down key. This will allow you to change your target heart rate at any time during the program.
8. During the HR program you will be able to scroll through the data in the message window by pressing the adjacent **Display key**.
9. When the program ends you may press Start to begin the same program again or Stop to exit the program or you can save the program you just completed as a custom user program by pressing the Facility key and following the instructions in the message window.

ASSEMBLY INSTRUCTIONS FOR MR100

1) Hardware

STEP 1.

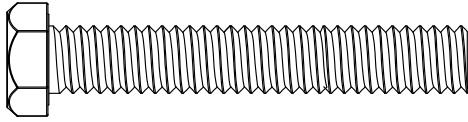

#65- 3/8" x 2- 1/4" (4PCS)

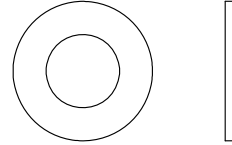

#77- 3/8" x 3/4" (8PCS)

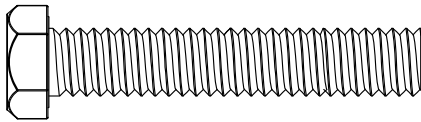

#71- 3/8" x 2" (4PCS)

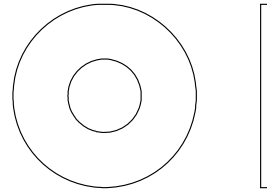

#84- 3/8" x 1" (4PCS)

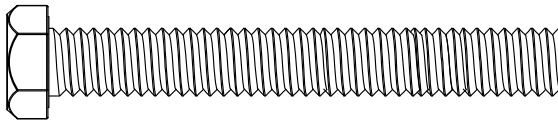

#175- 3/8" x 2-3/4" (2PCS)

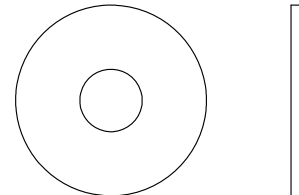

#205- 8.5mm x 26mm (2PCS)

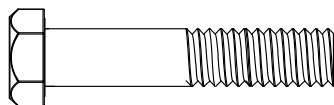

#208- 5/16" x 1-1/4" (1PC)



#89- 3/8" (6PCS)



#213- 5/16" (1PC)

STEP 2.



#216- M6 x P1.0 (2PCS)

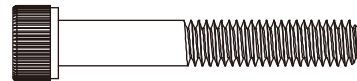

#221- M6 x P1.0 x 40L (2PCS)

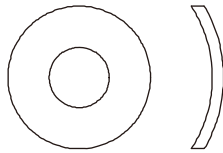

#83- 5/16" x 3/4" (4PCS)

STEP 3.

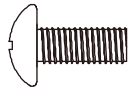

#136- M5 x 20L (4PCS)

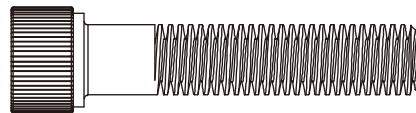

#220- 3/8" x 1-3/4" (2PCS)

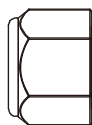

#215- 3/8" (2PCS)

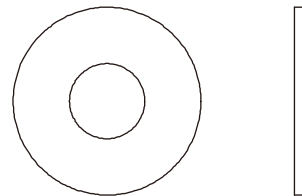

#206- 10mm x 25mm (2PCS)

STEP 4.

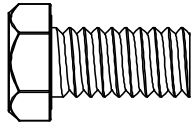

#68- 5/16" x 5/8" (8PCS)

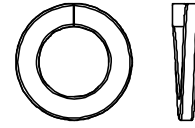

#82- 5/16" (2PCS)

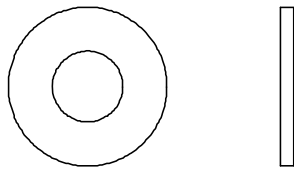

#76- 5/16" x 3/4" (6PCS)

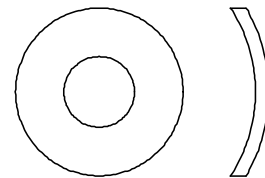

#83- 5/16" x 3/4" (2PCS)

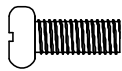

#187- M4 x 5L (4PCS)

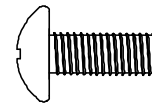

#98- M6 x 15L (2PCS)

STEP 5.

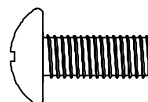

#99- M5 x 12L (8PCS)

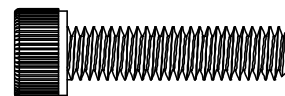

#222- M6 x 25L (4PCS)

2) Tools

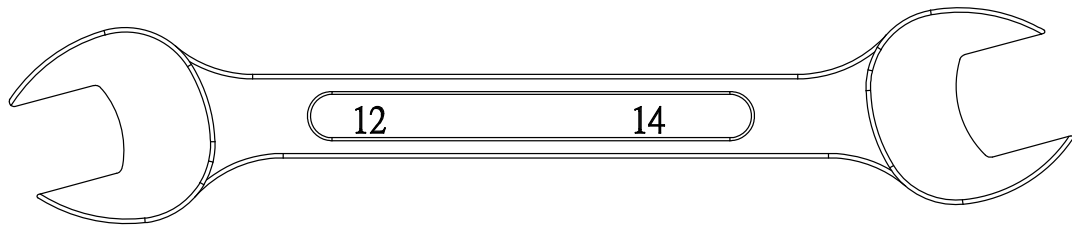

#112- 12.14m/m Open wrench (1PC)



#114- Phillips Head Screw Driver (1PC)

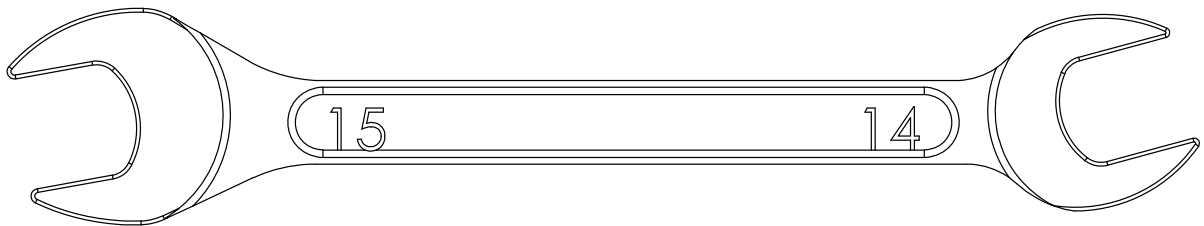

#132- 14.15m/m Open wrench (1PC)

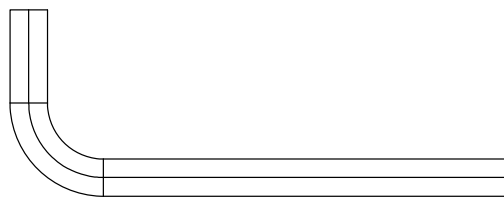

#200- 5m/m L Allen Wrench (1PC)

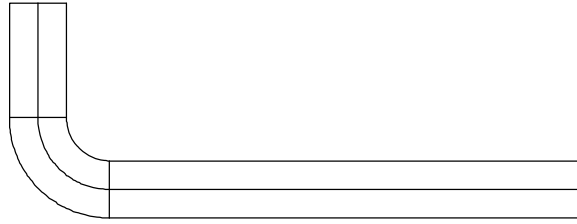

#283- 8m/m L Allen Wrench (1PC)

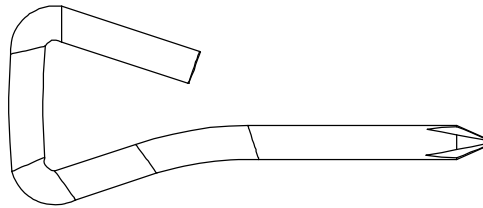

#201- Short Phillips Head Screw Driver (1PC)

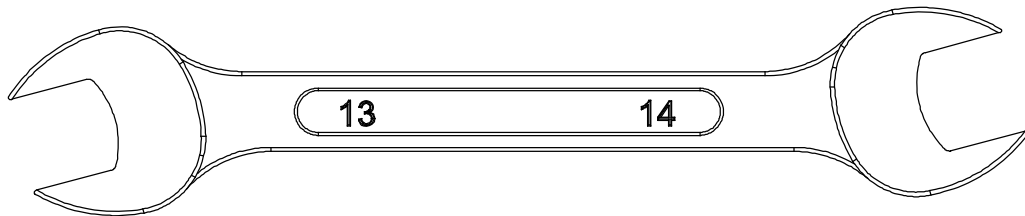

#284- 13.14m/m Open wrench (1PC)

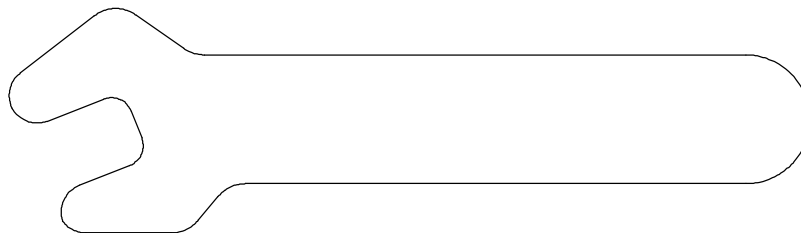

#280- 10m/m Wrench_single (1PC)

3) Assembly

IMPORTANT NOTE: Read each step's instructions and study the drawing carefully to become familiar with all the parts and procedures before beginning each step.

STEP 1: REAR STABILIZER AND HANDLE BAR ASSEMBLY

1. Install the Rear Stabilizer (7) onto the Main Frame (1) with the four 3/8" x 2-1/4" Hex Head Bolts (65) and four 3/8" Flat Washers (84).
2. ***This section is easier if you slide the seat carriage (38) all the way back before starting.** Slide the handle bar assembly (6) onto the receiving tubes of the seat frame (38). Secure the handle bar assembly starting with the two 3/8" x 2-3/4" bolts (175) (install from the inside hole of the receiving tube), four flat washers (77) and two nuts (89). ***Do not tighten the hardware for this section until the very end, after the safety cover (242) is attached.** Install the four 3/8" x 2" bolts (71) from the top side of the tubes and assemble the four 3/8" flat washers (77) and 3/8" nuts (89).
3. Attach the end of the gas shock (244) to the seat back angle adjustment bracket and secure with the 5/16" x 1-1/4" bolt (208), two 5/16" flat washers (205) and 5/16" nut (213).
4. Connect the left (L) and right (R) hand pulse wires together. Slide the safety cover (242) onto the handle bar bolts (175), between the frame and washer & nuts. Tighten all hardware securely.

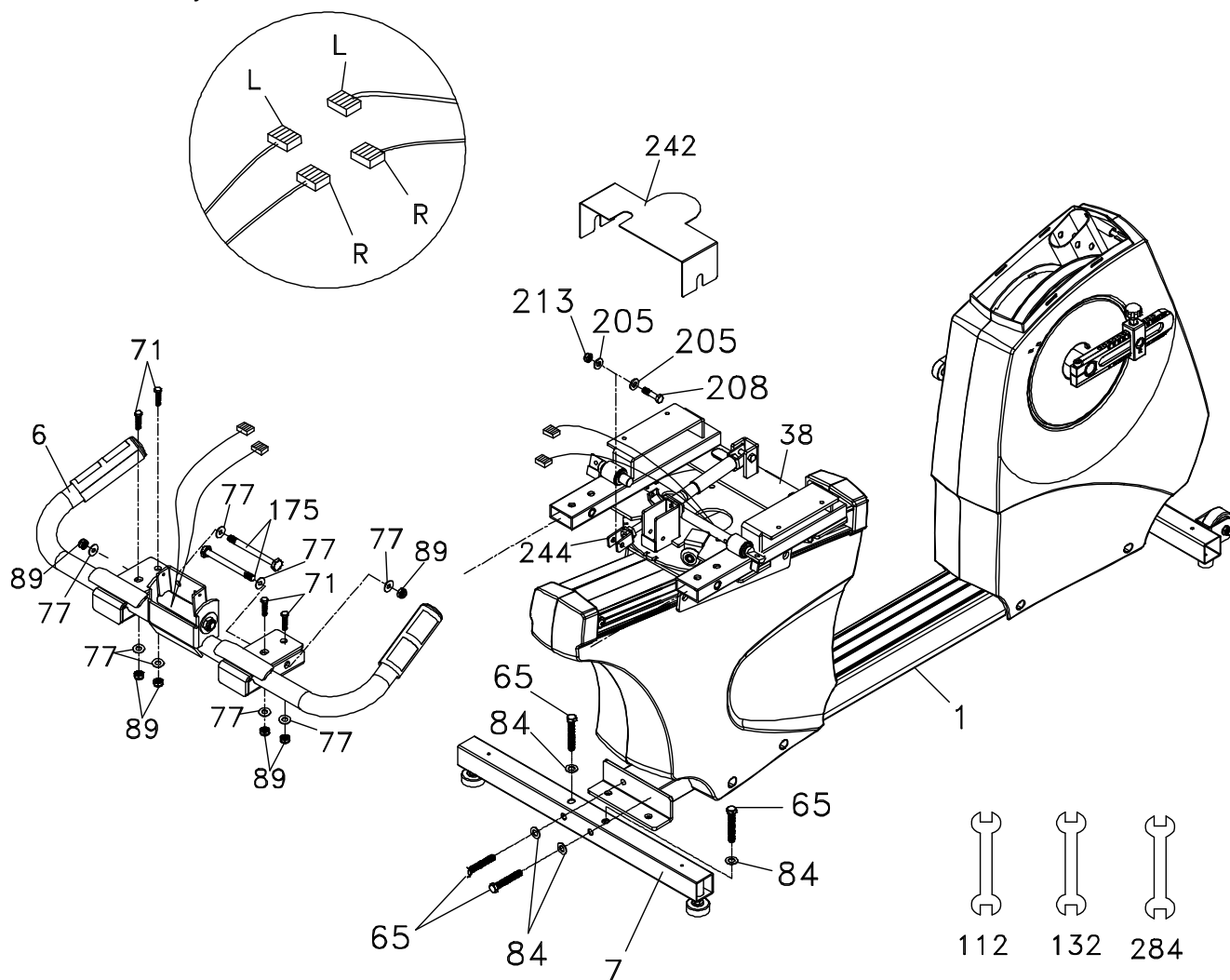

STEP 2: SWIVEL SEAT RELEASE HANDLE ASSEMBLY

1. Install the swivel seat release handle (40) onto the mating flat area of the solid round bars and secure with the two M6 x 40mm bolts (221), four curved washers (83) and two M6 nuts (216).

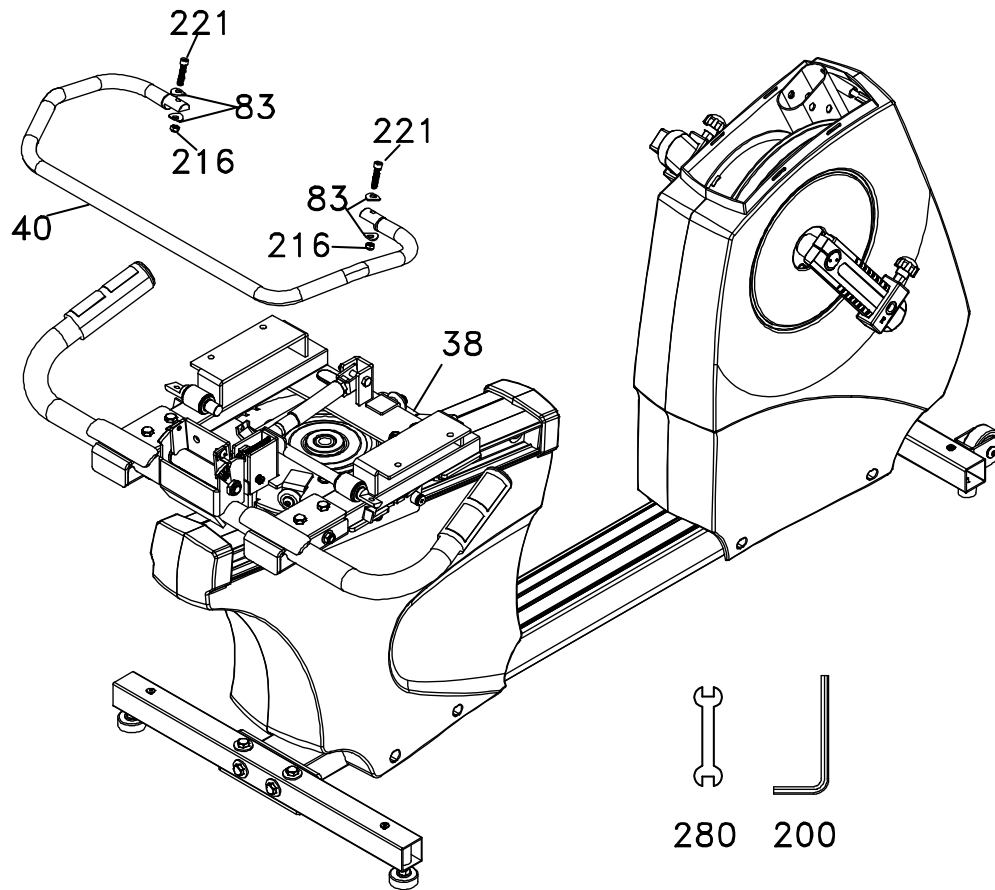

STEP 3: SEAT BACK AND COVER ASSEMBLY

1. Slide the seat back assembly (5) into the seat back angle adjustment bracket and secure with the two 3/8" x 1-3/4" bolts (220), 3/8" washers (206) and 3/8" nuts (215).
2. Install the seat back cover (128) onto the seat back assembly (5) with four M5 x 20mm screws (136).

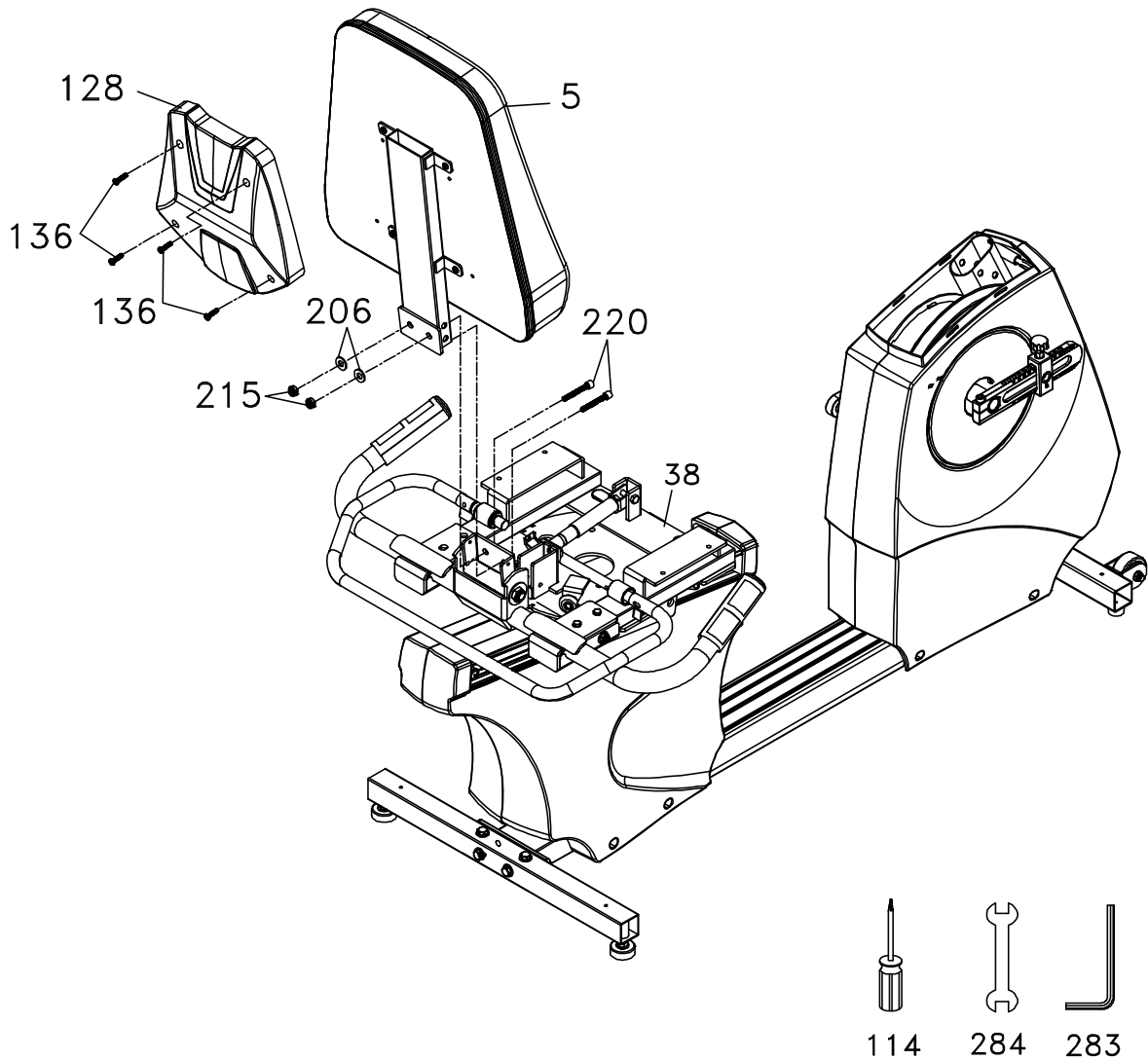

STEP 4: CONSOLE MAST, BRAKE LEVER AND HANDLE BAR ASSEMBLY

1. Locate the console mast cover (31) and route the computer and hand pulse cables (266, 269, 272) and the brake lever & cable (246) through the cover. Temporarily place the cover down on the main body of the bike. Do not snap the cover in place yet.
2. Unravel the computer and hand pulse cables (266, 269, 272) and snake them through the Console Mast (2) until the cables exit the top opening of the console mast. Be sure the brake cable (133) is in the groove of the cover when installing the mast during the next step.
3. Holding the console mast in one hand, and gently keeping tension on the cables at the top of the mast with the other, install the Console Mast (2) into the Main Frame receiving tube under the cover (31). Keeping tension on the cables will ensure the wires don't get caught between the mast and receiving tube. Do not bolt the mast in place at this time
4. Install the brake lever assembly (246) on the mast with the two 6mm Phillips screws (98). Install the covers (275) with the four 4mm screws (187). The top screws need to be tightened with the short screw driver.
5. Slide the mast cover (31) up the mast and bolt the mast in place with six 5/16" x 5/8" Hex Head bolts (68), four 5/16" Flat Washers (76) on the side bolts, and two 5/16" Curved Washers (83) on the front bolts. Slide the cover down and snap in place on the main body.
6. Assemble the handle bar to the mast with two 5/16" x 5/8" bolts (68), two 5/16" split washers (82) and two 5/16" flat washers (76).

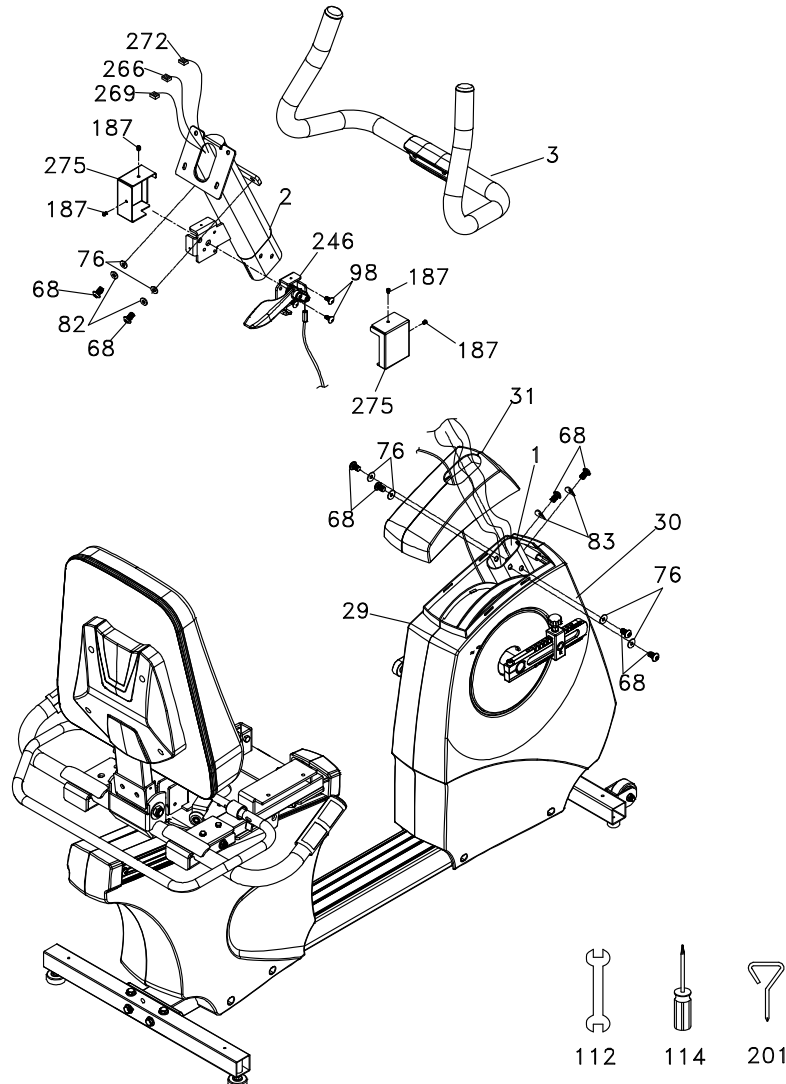

STEP 5: CONSOLE, SEAT, PEDALS AND COVERS ASSEMBLY

1. Install the front and rear stabilizer covers (32 & 37) with the four 5mm screws (99).
2. Install the seat cushion (61) with the four M6 x 25mm bolts (222).
3. Plug in all the connectors in their mating sockets in the back of the console. Install the console onto the mounting plate and secure with the four 5mm screws (99). Make sure to store the excess wire into the console mast and check that no wire is caught between the back of the console and the mounting plate before installing and tightening the screws. If the wires get pinched between the console and plate, damage could occur to the electronics.
4. Install the left (116) and right (117) pedals onto the crank arms. Remember that the left pedal has a reverse thread and will be screwed into the crank in the opposite rotation from normal threads. There is an "L" stamped into the end of the threaded post of the left pedal and an "R" in the right. Make sure to tighten the pedals as much as you possibly can. It may be necessary to re-tighten the pedals if you feel a thumping during pedaling the bike. A noise or feeling such as a thumping or clicking is usually caused by the pedals not being tight enough.
5. Remove the Allen screws from the lever clamps (249), fit them onto the Handle Bar (6) and secure with the Allen screws. Make sure the levers are positioned under the hand position and they are adjusted so the patient can comfortably reach them during use. The release levers are labeled Left and Right; the left lever with gray cable is for the fore/aft seat adjustment and the right lever with black cable is for the seat back angle.

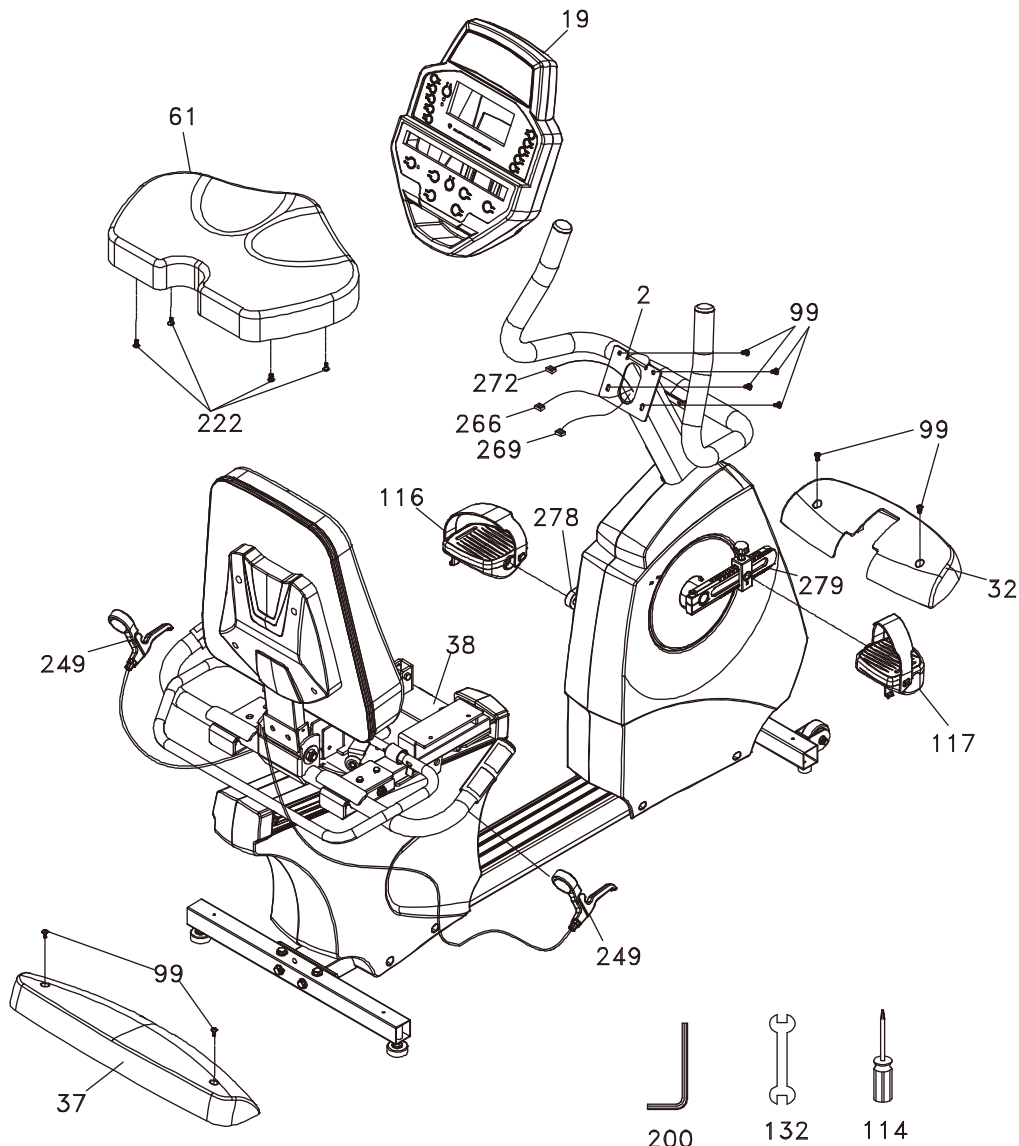

MR100 Exploded View Drawing

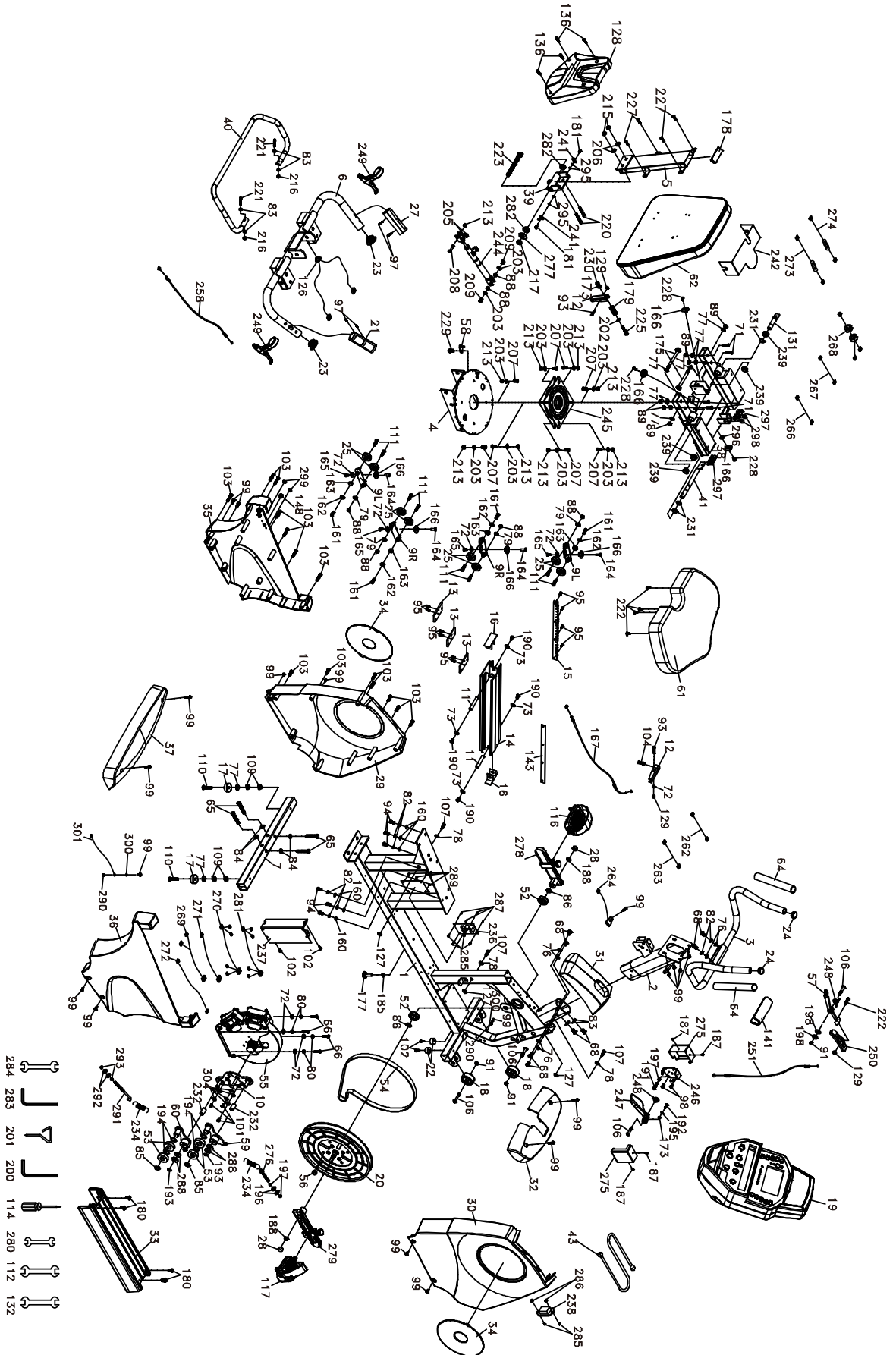

MR100 Parts List

Item	Description	Qty
1	Main Frame	1
2	Console Mast	1
3	Handle Bar, Front	1
4	Seat Carriage	1
5	Seat Back Bracket	1
6	Handle Bar, Rear	1
7	Rear Stabilizer	1
9L	Seat Wheel Adjustment Plate (L)	2
9R	Seat Wheel Adjustment Plate (R)	2
10	Idler Bracket	1
11	Axle, Seat Stop	2
12	Seat Position Latch	2
13	Backing Plate	3
14	Aluminum Track	1
15	Rack, Seat Position Index	1
16	Seat Assembly Stop	2
17	Rubber Foot, Leveler	2
18	Transportation Wheel	2
19	Console Assembly	1
20	Drive Pulley	1
21	Hand pulse Sensor W/Cable	1
22	Rubber Foot Pad	2
23	End Cap, Rear Handle Bar	2
24	End Cap, Front Handle Bar	2
25	Wheel, Seat Track	8
27	Hand pulse Sensor W/Cable (White)	1
28	End Cap, Crank Arm	2
29	Front Shroud (L)	1
30	Front Shroud (R)	1
31	Cover, Console Mast	1
32	Cover, Front Stabilizer	1
33	Step Cover, Aluminum	1
34	Round Disk, Crank	2
35	Rear Shroud (L)	1
36	Rear Shroud (R)	1
37	Cover, Rear Stabilizer	1
38	Swivel Seat Frame	1
39	Bracket, Seat Back Angle	1
40	Swivel Seat Release Handle	1

41	Adjusting Lever	1
43	Power Cord, Hospital Grade	1
52	6004_Bearing, Crank	2
53	6203_Bearing, Idler	4
54	Drive Belt	1
55	Induction Brake	1
56	Magnet, Crank Position	1
57	Mechanical Brake Lever	1
58	Rotation Stop, Swivel Seat	1
59	Bracket, Idler Wheel Assembly (Upper)	1
60	Bracket, Idler Wheel Assembly (Lower)	1
61	Seat Bottom	1
62	Seat Back	1
64	Handgrip Foam	2
65	3/8" x 2- 1/4" Hex Head Bolt	4
66	1/4" x 3/4" Hex Head Bolt	4
68	5/16" x 5/8" Hex Head Bolt	8
71	3/8" x 2" Hex Head Bolt	4
72	1/4" x 1/2" Flat Washer	9
73	1/4" x 3/4" Flat Washer	4
76	5/16" x 3/4" Flat Washer	6
77	3/8" x 3/4" Flat Washer	10
78	3/16" x 19/32" Flat Washer	3
79	Ø8mm x Ø18mm Knurled Lock Washer	4
80	1/4" Split Washer	4
82	5/16" Split Washer	8
83	5/16" x 3/4" Curved Washer	6
84	3/8" x 1" Flat Washer	4
85	17mm C-Clip	2
86	20mm C-Clip	2
88	M8 Nylon Nut	6
89	3/8" Nylon Nut	6
91	5/16" Nylon Nut	3
93	M6 x 38mm Socket Head Cap Bolt	2
94	5/16" x 3/4" Hex Head Bolt	6
95	M5 x 12mm Flat Head Socket Screw	10
97	3mm x 20mm Self Tapping Screw	4
98	M6 x 15mm Phillips Head Screw	2
99	M5 x 12mm Phillips Head Screw	19
101	M5 x 15mm Socket Head Cap Bolt	3
102	5mm x 19mm Self-Tapping Screw	4

103	3.5mm x 12mm Sheet Metal Screw	14
104	Ø12.9 x 30L_Spring	1
106	5/16" x 1-3/4" Button Head Socket Bolt	4
107	3.5mm x 20mm Sheet Metal Screw	3
109	3/8" x 7T Nut	4
110	3/8" x 2" Flat Head Socket Bolt	2
111	M5 x 10mm Flat Phillips Head Screw	8
112	12/14mm Wrench	1
114	Phillips Head Screw Driver	1
116	Pedal(L)	1
117	Pedal(R)	1
126	Wire Grommet, HGP	1
127	5/16" x 5/8" Flat Washer	3
128	Seat Back Cover	1
129	M6 Nylon Nut	3
131	Swivel Latch Bar (L)	1
132	14/15mm Wrench	1
136	M5 x 20mm Phillips Head Screw	4
141	Handle Bar Cover	1
143	Seat Position Scale, For/Aft	1
148	Dummy Plug	1
160	5/16" x 5/8" Flat Washer	6
161	M6 x 10mm Flat Phillips Head Screw	4
162	1/4" x 5/8" Flat Washer	4
163	5/8" x 13.2mm x 8mm Sleeve	4
164	M6 x 19mm Nut	4
165	M6 x 10mm Button Head Socket Bolt	4
166	Wheel, Poly Urethane	7
167	Steel Cable(1100L)	1
173	M5 x 5.0T_Nyloc Nut	2
175	3/8" x 2-3/4" Hex Head Bolt	2
177	Rubber Foot Pad	1
178	End Cap, Seat Back Tube	1
179	Ø13.5 x 60L Spring	1
180	M5 x 30mm Phillips Head Screw	4
181	M5 x 6mm Phillips Head Screw	2
185	3/8" Nut	1
187	M4 x 5mm Phillips Head Screw	4
188	M10 x 1.25mm Nut	2
190	M6 x 10mm Phillips Head Screw	4
191	M6 x 30mm Phillips Head Screw	1

192	M5 x 20mm Phillips Head Screw	1
193	10mm C-Clip	2
194	17mm x 23.5mm Flat Washer	4
195	5mm x 12mm Flat Washer	1
196	6.5mm x 25mm x 1.5T Flat Washer	2
197	M6 x P1.0 x 5.0T Nut	3
198	10mm x 24mm x 3T Nylon Washer	2
200	M5 Allen Wrench	1
201	Short Phillips Head Screw Driver	1
202	5.5mm x 15mm Flat Washer	1
203	8.5mm x 18mm Flat Washer	10
205	8.5mm x 26mm Flat Washer	2
206	10mm x 25mm Flat Washer	2
207	5/16" x UNC18 x 3/4" Hex Head Bolt	8
208	5/16" x UNC18 x 1-1/4" Hex Head Bolt	1
209	M8x 16mm Hex Head Bolt	2
213	5/16" x UNC18 Nylon Nut	9
215	3/8" x UNC16 x 7T(mm) Nyloc Nut	2
216	M6 x P1.0 Nylon Nut	2
217	M12 x P1.75 Nylon Nut	1
220	3/8" x UNC16 x 1-3/4" Socket Head Cap Bolt	2
221	M6 x P1.0 x 40 mm Socket Head Cap Bolt	2
222	M6 x P1.0 x 25 mm Socket Head Cap Bolt	5
223	M12 x P1.75 x 120 mm Socket Head Bolt	1
225	M5 x P0.8 x 70 mm Phillips Head Screw	1
227	M8 x P1.25 x 20mm Button Head Socket Bolt	4
228	M8 x P1.25 x 25L(mm)_Button Head Socket Bolt	3
229	5/16" x UNC18 x 3/4" Button Head Socket Bolt	1
230	M5 x P0.8 Lock Nut	1
231	Ø16mm C-Clip	3
232	14mm x 10mm (ID) x 25mm Sleeve Bearing	2
234	Ø16 x 66L x 13 Tension Spring, Idler	2
236	Switching Power Supply	1
237	Brake Controller	1
238	AC Input Module	1
239	15.9mm x 22mm Powder Metal Bearing	4
241	Scale Pointer	2
242	Cover	1
244	Gas Cylinder	1
245	Swivel Plate Assembly	1
246	Plate, Mech. Brake Lever	1

247	Release Lever, Mechanical Brake	1
248	Torsion-Spring	2
249	Lever, Mechanical Brake	2
250	Torsion Spring, Mech. Brake	1
251	Lever, Seat Back Angle	1
258	Steel Cable(84.5x76cm)	1
262	800m/m_Wire Brake Coil Harness(Red)	1
263	950m/m_Wire Brake Coil Harness(Red)	1
264	1300m/m_Sensor W/Cable	1
266	1950m/m_Computer Cable	1
267	350m/m_Connecting Wire, Adaptor Power Cord	1
268	1200m/m_Connecting Wire	1
269	2100mm Hand Pulse Sensor Assy. W/Cable	1
270	80mm Connecting Wire (White)	1
271	200mm Ground Wire	1
272	1500m/m_Computer Cable	1
273	800m/m Hand Pulse Extension Cable	1
274	800m/m Hand Pulse Wire	1
275	Cover, Mech. Brake	2
276	M6 x P1.0 x 57L Eye Bolt	1
277	Ø1/2" x Ø26 x 2.0T(mm) Flat Washer	1
278	Adjustable Crank Arm(L)	1
279	Adjustable Crank Arm(R)	1
280	10mm Wrench	1
281	80mm Connecting Wire (black)	1
282	12 x 18m/m Powder metal bushing	2
283	M8_L Allen Wrench	1
284	13/14mm Wrench	1
285	M4 x P0.7 x 12L(mm)_Phillips Head Screw	6
286	M4 x P0.7 x 5T(mm)_Nyloc Nut	2
287	Plastic Standoff	4
288	Ø10 x Ø25 x 0.8T(mm)_Nylon Washer	4
289	M4 x 3.5T(mm)_Nut	4
290	M5_Star Washer	2
291	M8 x P1.5 x 120L(mm)_J Bolt	1
292	Ø8.5 x Ø26 x 2.0T(mm)_Flat Washer	2
293	M8 x P1.25 x 6.0T(mm)_Luck Nut	2
295	Ø5 x Ø12 x 1.0T(mm)_Flat Washer	4
296	Ø8 x 1.5T(mm)_Spring Washer	1
297	25mm x 50m/m_Square End Cap	2
298	Ø8 x Ø20 x 1T(mm)_Nylon Washer	2

299	HGP Wire Grommet	2
300	Split Washer	2
301	Ground Wire (450mm,14AWG)	1
304	Ø5.5 x Ø15 x 1.5T_Flat Washer	6

Maintenance:

1. Wipe down all areas in the sweat path with a damp cloth after each use to prevent rust.
2. Check the pedal to make sure they are tight (monthly).
3. If a squeak, thump, clicking or rough feeling develops the main cause is most likely one of two reasons:
 - 1) The hardware was not sufficiently tightened during assembly. All bolts that were installed during assembly need to be tightened as much as possible. It may be necessary to use a larger wrench than the one provided if you cannot tighten the bolts sufficiently. I cannot stress this point enough; 90% of calls to the service department for noise issues can be traced to loose hardware.
 - 2) The crank arm nut and/or the pedals need to be retightened.
4. If squeaks or other noises persist, check that the unit is properly leveled. There are 2 leveling pads on the bottom of the rear stabilizer, use a ½” wrench (or adjustable wrench) to adjust the levelers.

Maintenance Menu in console software:

The console has built in maintenance/diagnostic software. The software will allow you to change the console settings from English to Metric and turn off the beeping of the speaker when a key is pressed for example. To enter the Maintenance menu (may be called Engineering mode, depending on version) press and hold down the Start, Stop and Enter keys. Keep holding the keys down for about 5 seconds and the message window will display “Engineering mode”. Press the enter button to access the menu below:

- a. **Key test**
 - i. Will allow you to test all the keys to make sure they are functioning. Press all the keys one at a time.
- b. **Display test**
 - i. Tests all the display functions by lighting each LED light sequentially.
- c. **Functions** (Press enter to access menu)
 - i. **Sleep mode**
 1. Turn on to have the console power down automatically after 20 minutes of inactivity, this is the default setting. Turn off and the console will remain on always unless the main power switch is turned off.
 - ii. **Pause Mode**
 1. Turn on allow 5 minutes of pause, turn off to have the console pause indefinitely.
 - iii. **Odometer reset**
 1. Resets the odometer to zero (Time and distance)
 - iv. **Units**
 1. Set to English (Imperial units) or Metric display readings. The default is Imperial, which means data such as bodyweight and height will be in Pounds and inches.
 - v. **Beep Sound**
 1. Turn on or off the speaker to silence beeping sound.
- d. **Security**
 - i. Allows you to lock the keypad so no unauthorized use is allowed. When the keypad is locked press the Start and Enter key for 3 seconds to unlock.
- e. **Factory settings**
 - i. **Brake Test**
 1. Allows you to manually change resistance levels one bit at a time to test whether the brake is functioning properly. There are 512 levels.
 - ii. **Sensor Test**
 1. The bike has two sensors, one angle sensor for speed/velocity measurements located on the brake, and one reed switch that measures crank rotation which we use to determine crank position.

2. MW will show: ANGLE 0 REED 0
 - a. When sensors operate correctly: rotate the crank and the Angle reading will show pedal RPM measurement and the Reed will change from 0 to 1 once per pedal revolution.
- iii. **Crank Position Cali**
 1. Software calibration to set the position of the right pedal at 12 o'clock.
 2. Set right pedal to 6 o'clock position then press start.
 3. Rotate the right pedal clockwise until the console beeps.
- iv. **Watts Calibration (Factory use only)**
- v. **Unit Type**
 1. Selects Upright bike (MU100) or Recumbent bike (MR100).

Error Messages

1. EEPROM Error – Solution for this is to replace the console (Note: this is the only error message)

Troubleshooting

Below are common problems and basic checks to solve them. If these tips do not solve your problem then call your local distributor for service.

1. **No Power:**
 - a. Make sure the A.C. outlet has power (90~240VAC), the line cord plugged in securely and the power switch is on.
 - b. Check the fuse in the Input module (located between the power switch and line cord input).
 - c. Make sure all connectors in back of the console are securely seated in place.
2. **Console programs do not start**
 - a. Perform Keypad test in Maintenance mode
 - b. If you cannot access the test, and the keys seem to have no affect when pressed, then the keypad has malfunctioned.
3. **Program starts but no data registers when bike is pedaled**
 - a. Check that the connectors are properly seated in the back of the consoles.
 - b. Perform the Sensor tests in Maintenance mode. If one of the sensors does not work it needs replacement. If both sensors do not work then it could be a bad console or both sensors are bad.
4. **Symmetry measurement is incorrect**
 - a. Perform the sensor tests in Maintenance Mode
 - b. If sensors are functioning then perform Crank Position Calibration
 - c. If calibration is ok then check the Unit Type is set to MR100.
5. **Pedal resistance seems harder/different than before**
 - a. Check the watts per level setting in the Set Up menu (see page 9). The default setting from the factory is 5 watts per level.
6. **Cannot adjust seat fore/aft or back angle, or seat adjustments will not lock in place**
 - a. Adjust the thumb nuts located to the rear of the seat adjustment levers. If the cables attached to the levers stretch it is possible the latch for the seat will not disengage, or engage, properly. Adjusting the thumb nut can remedy this.
7. **Clicking noise when pedaling**
 - a. Make sure the pedal is tightened properly. It is common to have to retighten the pedal after the first few hours use.
 - b. Make sure the adjustment knob for the pedal slide is tightened as much as possible.
 - c. Check that the leveling feet on the bottom of the bike are adjusted properly.

Specifications:

REF MR100

Dimensions: Length = 57" (145cm), Width = 30" (77cm), Height = 51" (130cm)

Weight: 180.1 lbs. (81.7 kg)

Patient weight capacity: 440 lb. (200 kg)

Power: 90-240V ~: 50/60 Hz: 1.76–0.71A

Fuse Rating: Replace with only 5A, 250V glass fuse. Fast acting ϕ 5.2 x 20 mm.

Resistance: Constant and Isokinetic with 50 levels of effort.

Work Load: 5 watts up to 750 watts.

Readouts: Time and Segment time remaining, RPM, Watts (Left and Right), METs, Symmetry Index, Heart Rate, Calories, Work Level

Certifications: TUV listed to ANSI/AAMI ES60601-1:2005+A2 (R2012) +A1, CAN/CSA-C22.2 No. 60601-1:14, CE conformity to EN 60601-1 EMC, Compliance to EN 60601-1-2

Classification: Class I measuring, Type B, ordinary equipment, continuous operation. This product is classed as ordinary equipment according to IEC/EN/UL60601-1.

Disposal: Reference should be made to local regulations concerning the disposal of this product at the end of useful life.



Dyaco International Inc.
12F, No.111, Songjiang Rd.
Taipei 104, Taiwan R.O.C.



Guidance and manufacturer's declaration – electromagnetic compatibility

The MR100 is intended for use in the electromagnetic environment specified below. The customer or the user of the MR100 should assure that it is used in such an environment.

Emissions test	Compliance	Electromagnetic environment – guidance	
RF emissions CISPR 11	Group 1	The MR100 uses RF energy only for its internal function. Therefore, its RF emissions are very low and are not likely to cause any interference in nearby electronic equipment.	
RF emissions CISPR 11	Class B	The MR100 is suitable for use in all establishments, including domestic establishments	
Immunity test	IEC 60601 test level	Compliance level	Electromagnetic environment – guidance
Electrostatic discharge (ESD) IEC 61000-4-2	6 kV contact 8 kV air	6 kV contact 8 kV air	Floors should be wood, concrete or ceramic tile. If floors are covered with synthetic material, the relative humidity should be at least 30 %.
Power frequency (50/60 Hz) magnetic field IEC 61000-4-8	3 A/m	3 A/m	Power frequency magnetic fields should be at levels characteristic of a typical location in a typical commercial or hospital environment.
Radiated RF IEC 61000-4-3	3 V/m 80 MHz to 2,5 GHz	3 V/m	$d = 1,2 \sqrt{P}$ 80 MHz to 800 MHz $d = 2,3 \sqrt{P}$ 800 MHz to 2,5 GHz Where P is the maximum output power rating of the transmitter in watts (W) according to the transmitter manufacturer and d is the recommended separation distance in meters (m). Field strengths from fixed RF transmitters, as determined by an electromagnetic site survey, a) should be less than the compliance level in each frequency range. B) Interference may occur in the vicinity of equipment marked with the following symbol: 

Recommended separation distances between portable and mobile RF communications equipment and the MR100

The MR100 is intended for use in an electromagnetic environment in which radiated RF disturbances are controlled. The customer or the user of the MR100 can help prevent electromagnetic interference by maintaining a minimum distance between portable and mobile RF communications equipment (transmitters) and the MR100 as recommended below, according to the maximum output power of the communications equipment.

Rated maximum output power of transmitter W	Separation distance according to frequency of transmitter m		
	150 kHz to 80 MHz $d = 1,2 \sqrt{P}$	80 MHz to 800 MHz $d = 1,2 \sqrt{P}$	800 MHz to 2,5 GHz $d = 2,3 \sqrt{P}$
	0,01	0,12	0,12
0,1	0,38	0,38	0,73
1	1,2	1,2	2,3
10	3,8	3,8	7,3
100	12	12	23

For transmitters rated at a maximum output power not listed above, the recommended separation distance d in meters (m) can be estimated using the equation applicable to the frequency of the transmitter, where P is the maximum output power rating of the transmitter in watts (W) according to the transmitter manufacturer.

NOTE 1 At 80 MHz and 800 MHz, the separation distance for the higher frequency range applies.

NOTE 2 These guidelines may not apply in all situations. Electromagnetic propagation is affected by absorption and reflection from structures, objects and people.









Immunity test	IEC 60601 test level	Compliance level	Electromagnetic environment – guidance
Electrical fast transient/burst IEC 61000-4-4	+/-2 kV for power supply lines +/-1 kV for input/output lines	+/-2 kV for power supply lines +/-1 kV for input/output lines	Mains power quality should be that of a typical commercial or hospital environment.



Note:

- If the device is interfered by power or signal cable, image quality may be reduced or abnormally displayed. Such kind of interference images could be easily identified and differentiated from the physiological characteristics of patient and longer clinical time consumed but wouldn't have any diagnostic accuracy issue.
- If there is a certain frequency of image interference, there is a need of isolation or filtering of the RF signal.

Description of Packaging Symbols

Symbols	Illustration
	<p>Indicates that the package is heavy and two or more people are required to lift.</p>
	<p>The broken wine glass suggests that the product inside the packaging could be easily damaged if dropped or handled without care and attention. The contents are fragile!</p>
	<p>Package contains fragile electronic equipment. Care should be used when handling.</p>
	<p>Do not use forklift truck here.</p>
	<p>Do not use Spade truck here.</p>
	<p>Hand truck only.</p>
	<p>Do not use Razorback truck here.</p>
	<p>Indicates that an object is capable of being recycled - not that the object has been recycled or will be accepted in all recycling collection systems.</p>
	<p>Top. This side up.</p>

Manufacturer's Limited Warranty

Dyaco Canada Inc. warrants all its bike parts for a period of time listed below, from the date of retail sale, as determined by a sales receipt or in the absence of a sales receipt. Dyaco Canada Inc.'s responsibilities include providing new or remanufactured parts, at Dyaco Canada Inc.'s option, and technical support to our independent dealers and servicing organizations. In the absence of a dealer or service organization, these warranties will be administered by Dyaco Canada Inc. directly to a consumer. The warranty period applies to the following components:

Warranty

Frame: Lifetime

EMS Brake: 5 years

Parts and Labour: 3 years

This warranty is not transferable and is extended only to the original owner.

The warranty shall not apply to exercise units which are subject to misuse, neglect, accident or unauthorized repair and alterations.

This warranty provided herein is lieu of all other express warranties, any implied warranties, including any implied warranties of merchantability of fitness for particular purpose, are limited in duration to the first 36 months from date of purchase. All other obligations or liabilities, including liability for consequential damages are hereby excluded.

REPAIR PARTS AND SERVICE

All of the parts for the Spirit unit shown in figure can be ordered from Dyaco Canada Inc. 5955 DON MURIE STREET, NIAGARA FALLS, ONTARIO L2G 0A9. When ordering parts, the parts will be sent and billed at the current prices. Prices may be subject to change without notice. Check or money order must accompany all orders. Standard hardware items are available at your local hardware store.

To ensure prompt and correct handling of any errors, or to answer any questions, please call our Toll Free number: 1-888-707-1880, or local number 1-905-353-8955 or fax 1-905-353-8968, email customerservice@dyaco.ca or visit our website at www.dyaco.ca. Office hours are from 8:30 AM to 5:00 PM Monday to Friday Eastern Standard Time.

Always include the following information when ordering parts

- Model number
- Name of each part
- Part number of each part



Please visit us online for information about our other brands and products manufactured and distributed by Dyaco Canada Inc.



www.dyaco.ca



www.dyaco.ca



www.dyaco.ca



www.dyaco.ca



www.spiritfitness.ca
www.dyaco.ca



www.spiritmedical.ca
www.dyaco.ca



www.solefitness.ca
www.dyaco.ca



www.trainorsports.ca
www.dyaco.ca



www.xterrafitness.ca
www.dyaco.ca