



# SPIRIT

MEDICAL  
SYSTEMS GROUP

*A Heritage of Quality | The Spirit of Innovation*



## **MS350** Rehabilitation Seated Stepper USER'S MANUAL



PLEASE READ THIS ENTIRE MANUAL CAREFULLY BEFORE OPERATING YOUR NEW SEMI-RECUMBENT STEPPER AND SAVE IT FOR FUTURE USE.

# Table of Contents

Product Registration.....	2
Important Safety Instructions.....	3
Important Electrical Information.....	4
Important Operation Instructions.....	4
Application Specification.....	5
Operating Principle.....	5
Significant Physical Characteristics.....	6
Significant Performance Characteristic.....	6
Intended User Profile.....	6
Operating The MS350.....	7
Features.....	8
Operation of Your New Stepper.....	12
MS350 Assembly Instructions.....	21
MS350 Drawing & Parts List.....	28
Maintenance.....	35
Specifications.....	37
Description of Packaging Symbols.....	40
Manufacturer's Limited Warranty.....	41



Thank you for your recent purchase of this high quality Semi-Recumbent Seated Stepper, the MS350, from Dyaco Canada Inc.

Your new product was manufactured by one of the leading fitness and medical products manufacturers in the world. Further, it is backed by one of the most comprehensive warranties in the industry. Through our dealers, distributors and manufacturer’s representatives, we will do all we can to provide many years of successful and prosperous ownership. Your warranty and service needs will be addressed collaboratively through your regional sales representative and our highly trained service technicians.

The responsibility of that collaborative team is to provide you with both the technical knowledge and access to service personnel to make your ownership experience more informed, and resolution of any difficulties easier to remedy.

Two components of the Spirit Medical Systems Group’s mission statement are “enhancing patient outcomes and improving effectiveness in the delivery of services”. This is just one of the many products that will assist you in providing that care to your patients and/or clients.

Please take a moment at this time to record the name of the dealer, distributor, or manufacturer’s representative, their telephone number, and the date of purchase below to make any future, needed contact easy. We appreciate your support and we will always remember that you are the reason that we are in business.

Yours in Health and Wellness,  
Dyaco Canada Inc

## ***Product Registration***

### **RECORD YOUR SERIAL NUMBER**

Please record the Serial Number of this fitness product in the space provided below. You can find the serial number on a sticker that is located on the front left side of the product.

**SN** \_\_\_\_\_

# Important Safety Instructions

- ⚠ **ATTENTION** - Read all instructions in this manual before using this device.
- ⚠ **DANGER** - To reduce the risk of electric shock disconnect the product from the electrical outlet prior to cleaning and/or service work.
- ⚠ **WARNING**: Do not modify this equipment without authorization of the manufacturer.
- ⚠ **WARNING** - To reduce the risk of burns, fire, electric shock, or injury to persons, install the unit on a flat level surface with access to a 100 to 240-volt AC, 50/60 Hz, 15-amp outlet. The unit should be the only appliance in the electrical circuit.
- Use this device only for its intended use as described in this manual.
- Keep children away from the device. There are moving parts, obvious pinch points and other caution areas that can cause harm.
- Except as instructed for use of the device, keep hands away from all moving parts.
- Keep the electrical cord away from heated surfaces and out of all travel lanes and do not operate the device if the cord or plug is damaged.
- Never drop or insert any object into any openings.
- Do not use outdoors.
- To disconnect, turn all controls to the off position then remove the plug from the outlet.
- This device is designed for commercial use and will meet the demands of orthopedic, sports wellness and general conditioning programs.
- Do not attempt to use the device for any purpose other than for the purpose it is intended.
- The pulse sensors are not medical devices. Various factors, including the user's movement, may affect the accuracy of heart rate readings. The pulse sensors are intended only as exercise aids in determining heart rate trends in general.
- **WARNING**: Heart rate monitoring system may be inaccurate. Over exercise may result in injury or death. If you feel faint stop exercising immediately.
- Ensure there is a minimum space on the sides of the unit of two feet for proper operation, easy access and to prevent possible injuries to others standing or walking nearby. There should be a minimum of at least one foot of free space at the front and rear of the unit.
- Do not use any after market parts on this device, other than those recommended by Spirit.
- Do not attempt any servicing or adjustments other than those described in this manual. All else must be left to trained service personnel familiar with electro-mechanical equipment and authorized under the laws of the country in question to carry out maintenance and repair work.
- Installation and assembly of this product should be performed by trained personnel only.
- To avoid injury please observe all minimum and maximum seat and arm adjustment settings.

# Important Electrical Information

## WARNING!

- ⚠ **NEVER** remove any cover without first disconnecting AC power. If voltage varies by ten percent (10%) or more, the performance of your bike may be affected. **Such conditions are not covered under your warranty.** If you suspect the voltage is low, contact your local power company or a licensed electrician for proper testing.
- ⚠ **NEVER** expose this product to rain or moisture. This product is **NOT** designed for use outdoors, near a pool or spa, or in any other high humidity environment.
- ⚠ The MS350 is NOT protected against the ingress of water or particulate matter.
- ⚠ The MS350 is not suitable for use in an oxygen rich environment.
- ⚠ If not stated otherwise Spirit devices are designed for operation in normal climatic surroundings (IEC 60601-1):
  - Temperature: + 10° ... + 36° C
  - Relative humidity: 30 ... 90 % (non condensing)
  - Air pressure: 700 ... 1060 mbar
  - Maximum operating altitude: approx. 10,000 feet (3000m), without pressurization
  - Transport and store the devices at a temperature of – 20° ... + 50° C.

# Important Operation Instructions

- **NEVER** use the device during an electrical storm. Surges may occur in your facility power supply that could damage the unit's components.
- **All users** should have medical clearance before starting any rigorous exercise program. This is especially important for persons with a history of heart disease or other high risk factors.
- **The user** should adjust the seat and arms to a position that is comfortable during exercise. The console has a program in the Setup menu that can aid in setting the correct seat and arm position.
- **Start** at a safe exercise level. Do not allow the user to be over exerted. Symptoms to watch for, but not limited to, are: Shortness of breath or difficulty in breathing, pain or discomfort, feeling faint.
- **Make sure** the user warms up and cools down properly to avoid over taxing the cardio vascular system. Allow three to five minutes of warm up and cool down during each exercise session.

# Application Specification

## Medical Purpose:

1. Patient warm up before physical therapy session
2. Have the patient pedal to improve range of motion after knee/hip/ankle/shoulder or wrist surgery.
3. Allow patients to perform cardiovascular exercise

## Intended Patient Population:

- There is no particular restriction on age, gender, height and nationality.
- Maximal patient's weight is 200kg.
- Patient must be ambulatory.
- Patient should have medical clearance before starting any rigorous exercise program. This is especially important for person with history of heart disease or other high risk factors.

## Intended Part of the Body or Type of Tissue Applied to or Interacted with:

1. Contact site: Hands, feet, and trunk
2. Condition: Should not have any trauma

## Intended Conditions of Use:

1. Environment including hygienic requirements:
  - (a) General: Intended for indoors use. This product is **NOT** designed for use outdoors, near a pool or spa, or in any other high humidity environment.
  - (b) Conditions of visibility:
    - Ambient luminance: Standard ambient room lighting is sufficient.
    - Viewing distance: 1 m
    - Viewing angle: 120°
  - (c) Physical:
    - Temperature range: 10°C ~36°C
    - Relative humidity range: 30% R.H. ~ 90% R.H., non condensing
  - (d) Hygienic requirements: There is no particular restriction on hygienic requirements.
2. Frequency of use: Dependant on therapist's plan.
3. Location: Intended for hospital use, clinic use, home use and research in academic institutions.
4. Mobility: The product is intended to be fixed.

# Operating Principle

The patient pushes the pedals with their feet and the arms with their hands. The operator can increase the workload using the Up and Down Key on the console. When the workload change is requested a gear motor moves permanent magnets closer or further from the aluminum flywheel creating more or less resistance.

# ***Significant Physical Characteristics***

Please refer to **Features** of MS350 manual.

# ***Significant Performance Characteristic***

Please refer to “Unique uses for the Spirit MS350” in **Operating The MS350** of MS350 manual.

# ***Intended User Profile***

Intended user:

1. Intended operator
  - There is no particular restriction on age, gender, height, weight, ability and culture.
  - Education: University or above
  - Knowledge: The operator should read the User’s Manual before use.
  - Discipline: The operator should receive training from the manufacturer before use.
  - Experience: The operator must have experience in physical therapy.
  - Background: The operator must be a major in physical therapy.
  - Professional competence: The operator should have the physical therapist license.
  
2. Intended Installer
  - There is no particular restriction on age, gender, height, weight, ability and culture.
  - Education: High School or above
  - Knowledge: The installer shall be able to manipulate this product properly.
  - Discipline: The installer shall be given a specific training by manufacturer.
  - Experience: The installer must have experience in product assembly and disassembly.
  - Background: The installer must be electro-mechanically trained.
  - Professional competence: Normal vision ability required.

# Operating The MS350

The Spirit Medical Systems Group Semi-Recumbent Stepper is intended to be used in aiding in the physical rehabilitation process for patients with orthopedic and neurological problems. Also used in sports medicine, wellness and general conditioning programs.

Typical applications for this type of product are:

1. Patient warm up before physical therapy session
2. Have the patient pedal to improve range of motion after knee/hip/ankle/shoulder or wrist surgery.
3. Allow patients to perform cardiovascular exercise

Unique uses for the Spirit MS350

1. Self adjustable step length allows patients to pedal in smaller range of knee motion, from 5 degrees to full range.
2. Arms are linked to the foot pedals for ease of coordination. Arms can also be used alone without stepping with feet.
3. Symmetry program measures balance between left and right pedal and/or arm stroke. Graphical Bio-feedback display motivates patients to maintain even power symmetry between left and right legs. If measuring arms only the graph and power readings will be reversed.

Other features of the MS350:

- Work range up to 750 watts.
- Indexed seat positioning accommodates users from 147 cm to 200 cm (4' 10" to 6' 7")
- Heart Rate monitoring using the hand grips or optional heart rate chest-strap.

\*Heart rate measurements are not for medical use:

*"The heart rate function on this product is not a medical device. While heart rate grips or a thumb pulse sensor can provide a relative estimation of your actual heart rate, they should not be relied on when accurate readings are necessary. Some people, including those in a cardiac rehab program, may benefit from using an alternate heart rate monitoring system like a chest or wrist strap. Various factors, including movement of the user, may affect the accuracy of your heart rate reading. The heart rate reading is intended only as an exercise aid for measuring heart rate trends in general.*



# Features

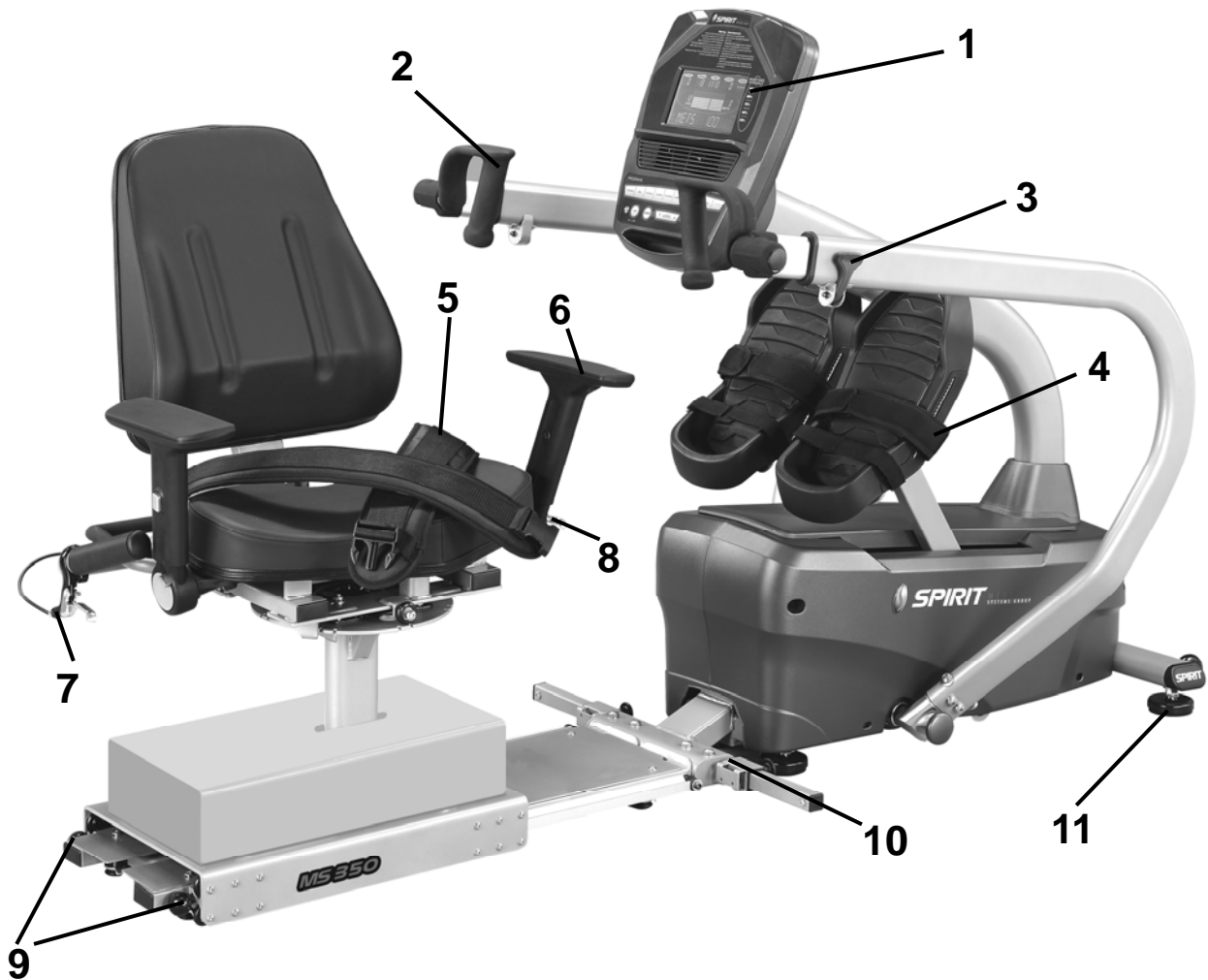

## MS350– Rehabilitation Seated Stepper

### Parts and Adjustments:

1. Electronic Console
2. Upper Body Rotating Handles
3. Quick Release lever
4. Cushioned Footplates with straps
5. Swivel Seat with seat belt
6. Arm Supports
7. Seat Angle Adjustment
8. Seat Position Adjustment
9. Seat Carriage Stops
10. Wheelchair Anchor
11. Leveling Glides

### Optional Parts (not shown):

- Wrist cuffs
- Calf Supports

The Spirit MS350 is an easy product to set up and use, from the adjustments to the intuitive interface. This section explains how to set up, adjust and operate your MS350 from Spirit Medical Systems Group.

### Leveling the MS350:

- Once the MS350 is assembled, and placed on a flat level floor, it may be necessary to adjust the leveling glides on the bottom of the unit to ensure proper stability of the MS350. Use a 1/2" wrench to loosen the top nut of the levelers. Adjust the front 4 corner levelers by hand as necessary to remove any wobble in the unit. Then tighten all the top nuts against the bottom of the stabilizer tubes. Make sure the bottom nut remains cinched against the leveling foot.

### Connecting to A.C. Power:

- The MS350 uses a universal switching power supply. You can plug the MS350 power supply into any A.C. power source from 100 to 240 volts, 50 to 60 Hz. The A.C. input is located in the front of the unit.

### Seat Adjustments:



### Adjusting the seat fore/aft position:

- Squeeze the brake handle located on the left side handle bar. Move the seat to the desired position and release the handle. Move the seat slightly until the seat lock clicks in place. There is a numbered scale located on the seat slide plate for repeatable settings. Seat position is indicated by the front of the seat carriage lining up with the number on the scale.

### Adjusting the seat back angle:

- To adjust the seat back angle, squeeze the brake handle located on the right side handle bar and move the seat back to the desired position. There is a numbered scale located just below the seat back cushion for repeatable settings.

### Rotating the swivel seat:

- Lift the handle behind the seat to disengage the latch. Rotate the seat to the desired position; lower the handle when approaching position to activate latch. The seat will latch into place every 45 degrees

## Wheelchair Attachment



- To use the MS350 with a wheelchair remove the two pins at the rear of the seat tracks, squeeze the seat adjustment lever and slide the seat assembly off the rear of the MS350. Roll the wheelchair in position and secure to the machine using the straps as shown above.

## Pedal strap adjustment:



- Remove the ankle strap from the chrome ring. Loosen the foot strap enough so the patient's foot can slide under. Once the foot is in the correct position reattach the ankle strap and adjust both straps for a snug fit.

### Seat Belt adjustment:



- Simply snap the buckles together and adjust the strap to the desired fit.

### Rotating Handle:



- Handles rotate to allow wrist patients to use upper body without discomfort.

- **MS350 Electronic Console:**



## Power on

When initially powered on the console will perform an internal self-test. During this time all the lights will turn on for a short time. The message window will then show a software version (i.e. VER 1.0) and the Time window will display the total hours the unit has been used to date.

The odometer will remain displayed for only a few seconds then the console will go to the start up display, also known as Idle Mode. The dot matrix display will be scrolling through the different program profiles and the message window will be scrolling the start up message. You may now begin to use the MS350.

The console will automatically power down after 20 minutes of inactivity. Press any key to wake the console up again. Always disconnect the main power when the MS350 is not in use.

## **Console Operation:**

### **1. Set Up Key**

The Set Up key function will allow you to set seat and arm adjustments for various patient heights and customize the settings of the MS350. When the Set Up key is pressed the first option in the menu appears. Use the up/down arrows to scroll through the menu and press the enter key to select an option.

#### **Set Up menu:**

##### Position (seat and arm position setting):

User may input their height in inches (or centimeters if unit is set to metric measurements, see page 35) and the software will calculate the position for the seat and arms. This feature is intended to aid in patient set up but may not be the final settings as patient's body symmetry may vary slightly.

##### Track or Step graph

The segmented track surrounding the profile display area can be set to display as a track or a foot position indicator. During any program press the Symmetry key to switch the display.

### **2. Quick Start**

This is the quickest way to start an exercise session. After the console powers up you just press the Start key to begin; this will initiate the Quick Start mode. In Quick Start, the Time will count up from zero, all workout data will start to accrue and the workload may be adjusted manually by pressing the Up or Down key. The dot matrix will display a workload level at the lowest resistance. As you increase the workload more rows will light indicating a harder workout. The unit will get harder to pedal as the rows increase.

The graphic display has 20 columns of lights with each column representing 1 minute in the Quick Start program (time per column can be modified in other programs). At the end of the 20<sup>th</sup> column (or 20 minutes of work) the display will wrap around and restart at the first column again. There are 20 levels of resistance displayed in 8 rows of lights.

### **3. Basic information**

The **Graphics Display** (dot matrix) is used for displaying work profiles and the Symmetry graph. When you begin a program the dot matrix will display a workload profile. The profile indicates the different resistance level changes during a program. The peak resistance level can be set during program setup. The peak setting can be adjusted during your workout also. When adjusting the peak level during a program the profile picture will not change, but the message window will display your new level setting.

The **Data Display** windows provide exercise information during a session. Information includes: SPM (Steps Per Minute), Calories, Time, Steps (total step count) and Pulse. Resistance level and Watt measurements are displayed on either side of the graphic display.

The **Message Window** is the main display for programming instructions and relevant measurements during a program. The measurement data shown varies depending on the program. Measurements include: Average Watts (Left and Right leg), METs, Symmetry and Segment time.

To the right of the Dot matrix display is a **Heart Rate Bar Graph**. Simply grasping the hand pulse sensors, or wearing a heart rate chest belt transmitter, will start the heart rate measurement function (this may take a few seconds). The Pulse window will display the heart rate in beats per minute. The Bar Graph represents the percentage of maximum heart rate. NOTE: Enter the correct age in Set Up for the Bar Graph to be accurate. Refer to Heart Rate section for details about these features.

### Function Keys:

The **Stop/Reset** key provides several functions.

- Pressing the Stop/Reset key once during a program will **Pause** the program. To resume the exercise session just press the Start key.
- If the Stop/Reset button is pressed twice during a workout the program will end and a summary of information for the exercise session will be displayed.
- If the Stop/Reset key is held down for 3 seconds the console will perform a complete **Reset**.
- During data entry for a program the Stop/Reset key performs a **Previous Screen** function. This allows you to go back one step in the programming each time you press the Stop/Reset key.
- The **Enter** key is used for entering data during programming and is also used to scroll through different data in the message window during exercise.

The **Program Keys** may be used to preview each program when in the idle mode. Press each program key to preview what the program profile looks like. To begin a program press the corresponding program key and then press the Enter key to select the program.

The program keys also function as a **Number Key Pad** when you are in the data-setup mode. If you are entering new data such as Time, Age, weight etc., you can use these keys to enter the numbers quickly. The Manual key would enter the number 1, Hill key is number 2, etc.

## 4. Selecting and customizing programs

When you enter a program you have the option of modifying the settings. If you want to begin without entering new settings just press the Start key. This will bypass the programming of data and take you directly to the start of the program. If you want to change the settings just follow the instructions in the message window. If you start a program without changing the settings the data from the Set Up menu will be used.

### Manual

The Manual program works as the name implies, manually. This means that you control the workload yourself, not the computer. To start the Manual program follow the instructions below or just press the Manual button then the Enter button and follow the directions in the message window.

1. Press the **Manual** key then press the **Enter** key.
2. The message window will prompt you to enter the Age, Weight and Time for the program. You may enter the Age using the Up and Down keys or the numeric key pad then press the Enter key to accept and proceed to the next screen.
3. Now you are finished editing the settings and can begin the program by pressing the Start

key. You can also go back and modify your settings by pressing the Enter key. NOTE: At any time during the editing of Data you can press the Stop key to go back one level, or screen.

4. During the Manual program you will be able to scroll through the data in the message window by pressing the **Enter key**.
5. When the program ends you may press Start to begin the same program again or Stop to exit the program, or you can save the program you just completed as a custom program by pressing the User keys and following the instructions in the message window.

## Preset Programs

The Semi-Recumbent Seated Stepper has four preset exercise programs that have been designed for a variety of workout goals. The initial built-in level of difficulty for each program is set to a relatively easy level. You may adjust the level of difficulty (Max level) for each program before beginning.

The profiles shown in the dot matrix are merely pictures of the whole profile and will not change in size when the work level keys are pressed. When setting up a program you will enter the maximum resistance setting for the peak of the profile. During the program the resistance levels will change as the profile progresses. When the level up key is pressed to request more resistance the profile picture will not change, but the workload will increase. The message window will display the level setting for the current segment and also the maximum level for the peak of the profile. Pressing the work keys actually change the peak level of the program not the current segment level. You may need to change the peak setting several times before the current segment increases.

## HILL

The **Hill** program simulates going up and down a hill. The resistance in the pedals and upper body arms will steadily increase and then decrease during the program.



## PLATEAU

The **Plateau** program provides a steady state exercise with warm up and cool down periods.

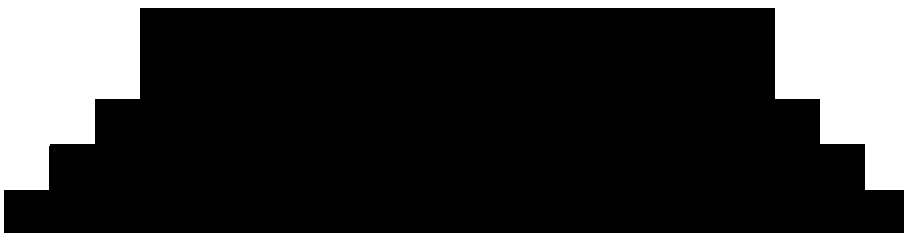



## CARDIO

The **Cardio** program is designed to increase Cardio vascular function. This is exercise for heart and lungs. It will build up heart muscle and increase blood flow and lung capacity. This is achieved by incorporating a higher level of exertion with slight fluctuations in work.



## INTERVAL

The **Interval** program takes you through high levels of intensity followed by periods of low intensity. This program increases endurance by depleting oxygen levels followed by periods of recovery to replenish oxygen. The cardio vascular system gets programmed to use oxygen more efficiently this way.



### Programming Preset Programs:

1. Select the desired program button then press the **Enter** key.
2. The message window will prompt you to enter the Age, Weight, Time and Max Level for the program. You may enter the Age using the Up and Down keys or the numeric key pad then press the Enter key to accept and proceed to the next screen.
  - a. Max Level refers to the top resistance level setting for the program.
3. Now you are finished editing the settings and can begin the program by pressing the Start key. You can also go back and modify your settings by pressing the Enter key. NOTE: At any time during the editing of Data you can press the Stop key to go back one level, or screen.
4. During the Manual program you will be able to scroll through the data in the message window by pressing the **Enter key**.
5. When the program ends you may press Start to begin the same program again or Stop to exit the program, or you can save the program you just completed as a custom program by pressing the User keys and following the instructions in the message window.

## User Programs

The User1&2 programs allow you to build and save a custom program. You can build your own custom program by following the instructions below or you can save any other preset program you complete as a custom program. The User program allows you to further personalize it by adding your facility name.

### Designing and saving a new program:

1. Press either User key. The message window will show a welcome message; if you had previously saved a program the message will contain the name you gave it. Then press the **Enter** key to begin programming.
2. When you press enter, the message window will show “Name – A”, if there is no name saved. If the name “Custom Workout” had been previously saved the message window will show “Name – Custom Workout” and the C in Custom will be blinking. If there is a name saved you can change it or you may press the Stop key to keep the name and continue to the next step. If you want to enter a name use the Up and/or the Down key to change the first letter then press Enter to save the first letter and continue to the next letter. When you have finished entering the name press the Stop key to save the name and continue to the next step.
3. The message window will ask you to enter an **Age**. You may enter an Age, using the Up and Down keys or the numeric key pad, then press the Enter key to accept the new number and proceed on to the next screen.
4. You are now asked to enter a **Weight**. You may adjust the Weight number using the Up and Down keys or the numeric key pad then press enter to continue.
5. Next is **Time**. You may adjust the Time and press enter to continue.
6. Now you are asked to adjust the **Max Level**. This is the peak exertion level you will experience during the program. Adjust the level and then press enter.
7. Now the first column will be blinking and you are asked to adjust the level for the first segment of the workout. When you finish adjusting the first segment, or if you don't want to change, then press enter to continue to the next segment.
8. The next segment will show the same level as the previously adjusted segment. Repeat the same process as the last segment then press enter. Continue this process until all twenty four segments have been set.
9. The message window will then tell you to press enter to save the program. After saving the program the message window says “New program saved” then will give you the option to Start or modify the program. Pressing Stop will exit to the start up screen.
10. During the Facility program you will be able to scroll through the data in the message window by pressing the **Enter** key.

### Running a saved program:

1. Press User key then Enter
2. Enter Time then press start to begin program.

## Symmetry

The Symmetry program may aid in achieving a more balanced exercise stroke for patients with bi-lateral deficiencies, such as stroke patients and post-op knee patients. The program will measure the left and right power through the pedal range. The Dot Matrix display will show a graph indicating the leg power symmetry so the user has a visual feedback to aid in improving the involved limb's strength. The program will also work for upper body only. When pushing the handles, the graph will be reversed (Left side will actually be displaying right arm information). It will be correct if the patient is pulling.

1. Press the Symmetry key then press the **Enter** key.
2. The message window will prompt you to enter the Age, Weight and Time for the program. You may enter the Age using the Up and Down keys or the numeric key pad then press the Enter key to accept and proceed to the next screen.
3. Now you are finished editing the settings and can begin by pressing the Start key. You can also go back and modify your settings by pressing the Enter key. NOTE: At any time during the editing of Data you can press the Stop key to go back one level, or screen.
4. During the program you will be able to scroll through the data (Watts, Symmetry, METs) in the message window by pressing the **Enter** key.

### For Best Results:

The Symmetry program starts at level 1 and the resistance needs to be increased manually by pressing the Up arrow. Make sure to set the resistance to a level where the patient is doing enough work to generate a meaningful measurement. It is recommended to set the resistance as high as the patient can perform without discomfort, but low enough so they can complete full pedal strokes. Very low resistance settings result in erratic or inconsistent measurements.

### Biofeedback Graph:

Below is a sample picture showing the symmetry graph. In the message window there is an average watt measurement and it is indicating that the left leg is producing more power than the right leg, 41 vs. 34 watts. The graph reflects the higher wattage of the left leg. If the power is equal in both legs only two dots would be lit on the bottom center of the graphic screen. Press the Enter key to view the Symmetry data.



Note: The Symmetry program uses a power table and velocity measurements to generate the watt readings; they are not from direct force measurements.

# Using a Heart Rate Transmitter

\*NOTE: The chest strap transmitter is not a standard part, but is a separate purchase. A chest strap transmitter may be purchased from Spirit. Most transmitters that operate at 5kHz frequency will also work.

How to wear your wireless chest strap transmitter:

1. Attach the transmitter to the elastic strap using the locking parts.
2. Adjust the strap as tightly as possible as long as the strap is not too tight to remain comfortable.
3. Position the transmitter with the logo centered in the middle of your body facing away from your chest (some people must position the transmitter slightly left of center). Attach the final end of the elastic strap by inserting the round end and, using the locking parts, secure the transmitter and strap around your chest.
4. Position the transmitter immediately below the pectoral muscles.
5. Sweat is the best conductor to measure very minute heart beat electrical signals. However, plain water can also be used to pre-wet the electrodes (2 black square areas on the reverse side of the belt and either side of transmitter). It's also recommended that you wear the transmitter strap a few minutes before your work out. Some users, because of body chemistry, have a more difficult time in achieving a strong, steady signal at the beginning. After "warming up", this problem lessens. As noted, wearing clothing over the transmitter/strap doesn't affect performance.
6. Your workout must be within range - distance between transmitter/receiver – to achieve a strong steady signal. The length of range may vary somewhat but generally stay close enough to the console to maintain good, strong, reliable readings. Wearing the transmitter immediately against bare skin assures you of proper operation. If you wish, you may wear the transmitter over a shirt. To do so, moisten the areas of the shirt that the electrodes will rest upon.

*Note: The transmitter is automatically activated when it detects activity from the user's heart. Additionally, it automatically deactivates when it does not receive any activity. Although the transmitter is water resistant, moisture can have the effect of creating false signals, so you should take precautions to completely dry the transmitter after use to prolong battery life (estimated transmitter battery life is 2500 hours). If your chest strap has a replaceable battery the replacement battery is Panasonic CR2032.*

## Erratic Operation:

**Caution! Do not use the MS350 for Heart Rate Control unless a steady, solid Actual Heart Rate value is being displayed. High, wild, random numbers being displayed indicate a problem.**

**Areas to look at for interference, which may cause erratic heart rate:**

- (1) Microwave ovens, TVs, small appliances, etc.
- (2) Fluorescent lights.
- (3) Some household security systems.
- (4) Perimeter fence for a pet.
- (5) Some people have problems with the transmitter picking up a signal from their skin. If you have problems try wearing the transmitter upside down. Normally the transmitter will be oriented so the Spirit logo is right side up.
- (6) The antenna that picks up your heart rate is very sensitive. If there is an outside noise source, turning the whole machine 90 degrees may de-tune the interference.
- (7) If there is another person wearing a chest strap within 1 meter, it will interfere.
- (8) *If you continue to experience problems contact your dealer.*

## Heart Rate Program operation

To start the **HR** program follow the instructions below or just press the HR key then the Enter button and follow the directions in the message window.

1. Press the **HR** key then press the **Enter** key.
2. The message window will ask you to enter your **Age**. You may enter your Age, using the Up and Down keys or the numeric key pad, then press the Enter key to accept the new number and proceed on to the next screen.
3. You are now asked to enter your **Weight**. You may adjust the Weight number using the Up and Down keys or the numeric key pad, then press enter to continue.
4. Next is **Time**. You may adjust the Time and press enter to continue.
5. Now you are asked to adjust the **Heart rate Level**. This is the heart rate level you will experience during the program. Adjust the level and then press enter.
6. Now you are finished editing the settings and can begin your workout by pressing the Start key. You can also go back and modify your settings by pressing the Enter key. NOTE: At any time during the editing of Data you can press the Stop key to go back one level, or screen.
7. If you want to increase or decrease the workload at any time during the program press the Up or Down key. This will allow you to change your target heart rate at any time during the program.
8. During the HR program you will be able to scroll through the data in the message window by pressing the **Enter key**.
9. When the program ends you may press Start to begin the same program again or Stop to exit the program or you can save the program you just completed as a custom user program by pressing a User key and following the instructions in the message window.

# ASSEMBLY INSTRUCTIONS FOR MS350

## 1) Hardware

### STEP 1.

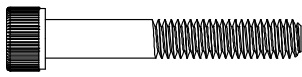

#128. M6 x 40L (2pcs)

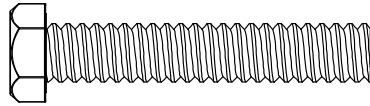

#132. 3/8" x 2" (4pcs)

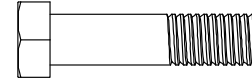

#135. 5/16" x 1-1/4" (1pc)

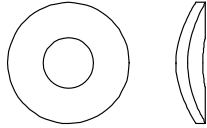

#185. 5/16" x 3/4" (4pcs)

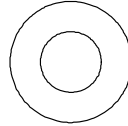

#170. 3/8" x 3T (8pcs)

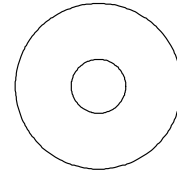

#173. 5/16" x 1" (2pcs)

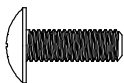

#181. M5 x 15L (12pcs)

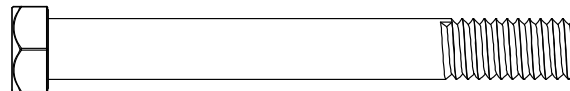

#140. 3/8" x 3-1/4" (2pcs)

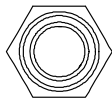

#190. 3/8" x 7T (6pcs)



#193. 5/16" x 6T (1pc)



#187. M6 x 6T (2pcs)

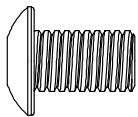

#216. 3/8" x 5/8" (2pcs)

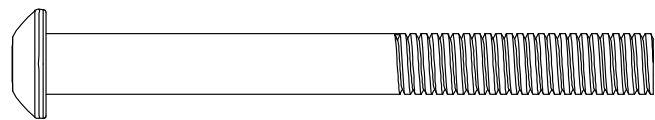

#206. 3/8" x 3-3/4" (2pcs)

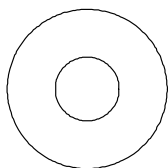

#217. 3/8" x 2T (6pcs)

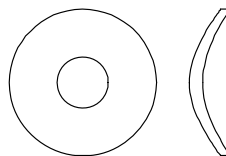

#218. 3/8" x 3T (4pcs)

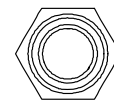

#255. 3/8" x 11T (2pcs)

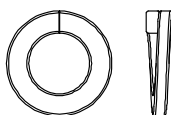

#243. 3/8" (8pcs)

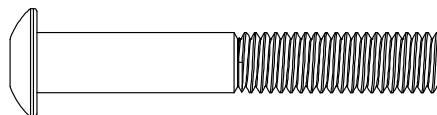

#178. 3/8" x 2-1/2" (2pcs)

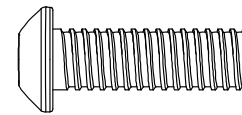

#258. M10 x 30L (2pcs)

**STEP 2.**

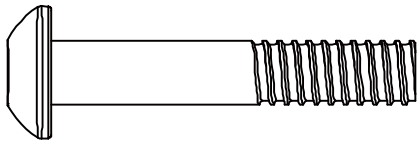

#152. 5/16" x 1-3/4" (2pcs)

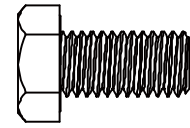

#153. M8 x 16L (2pcs)

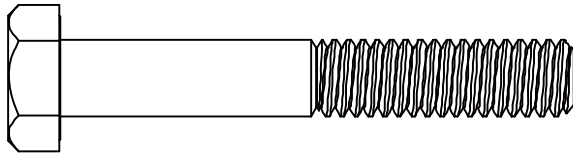

#154. 3/8" x 2-1/2" (2pcs)

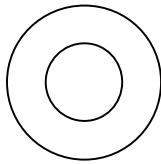

#170. 3/8" x 3T (2pcs)

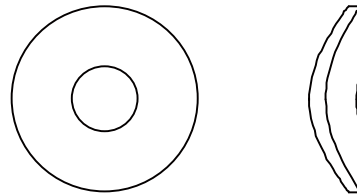

#184. 3/8" x 7/8" (2pcs)

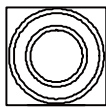

#160. M8 x 6.5T (6pcs)

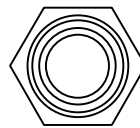

#190. 3/8" x 7T (2pcs)

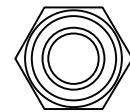

#193. 5/16" x 6T (2pcs)

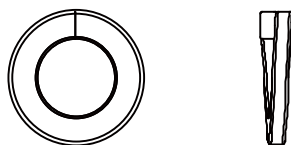

#194. 3/8" (2pcs)

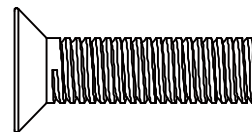

#196. M8 x 30L (6pcs)

**STEP 3.**

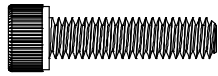

#122. M6 x 25L (4pcs)

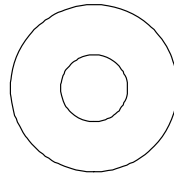

#167. 3/8" x 1" (2pcs)

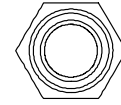

#190. 3/8" x 7T (2pcs)

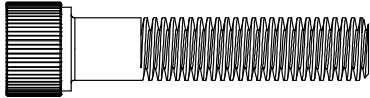

#197. 3/8" x 1-3/4" (2pcs)

**STEP 4.**

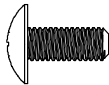

#143. M5 x 12L (4pcs)

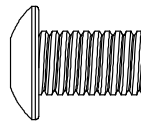

#216. 3/8" x 5/8" (8pcs)

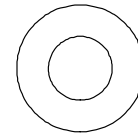

#217. 3/8" x 3/4" (4pcs)

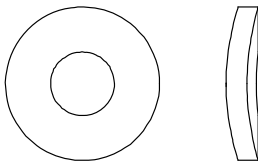

#218. 3/8" x 7/8" (4pcs)

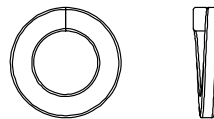

#243. 3/8" (8pcs)



## 2) Assembly

### STEP 1: PEDALS, SEAT LATCH HANDLE AND HANDLE BAR ASSEMBLY

1. Slide the handle bar assembly (17) onto the receiving tubes of the seat frame. Secure the handle bar assembly starting with two 3/8" x 3-1/4" bolts (140), four 3/8" flat washers (170) and two two 3/8" nylon nuts (190). **NOTE: Install the safety cover (108) and seat belts (223) onto bolts before assembling washers and nuts.** Install four 3/8" x 2" bolts (132) from the top side of the tubes and secure with four 3/8" flat washers (170) and 3/8" nylon nuts (190).
2. Attach the end of the seat back gas shock to the seat back angle adjustment bracket of the handle bar assembly (17) using one 5/16" x 1-1/4" bolt (135), two 5/16" flat washers (173) and 5/16" nylon nut (193).
3. Assemble swivel seat latch handle (22) to the seat assembly with two 6mm x 40mm bolts (128), four 5/16" curved washers (185) and two 6mm nylon nuts (187)
4. Assemble the rubber isolators (82) and pedals (28) to the pedal foot plates with six M5 Phillips screws (181) per side.
5. Press the two stabilizer end caps (31) into the stabilizer tubes. May tap in with a rubber mallet.
6. Install the two wheelchair anchor assemblies (235) with the 3/8" x 5/8" bolts (216) and M10 x 30 bolts (258) into the outside holes in the top of the frame tube and 3/8" flat washers (217) and 3/8" split washers (243) on the top of the tube and the 3/8" curved washers (218) on the front of the tube.
7. Install the seat assembly (18) with the 3/8" x 2-1/2" bolts (178) and use the 3/8" flat washers (217) and 3/8" split washers (243) on the top of the tube and 3/8" flat washers (217) and 3/8" nut (255) on the bottom of the tube and the 3/8" x 3-3/4" bolts (206) the 3/8" curved washers (218) on the front of the tube.

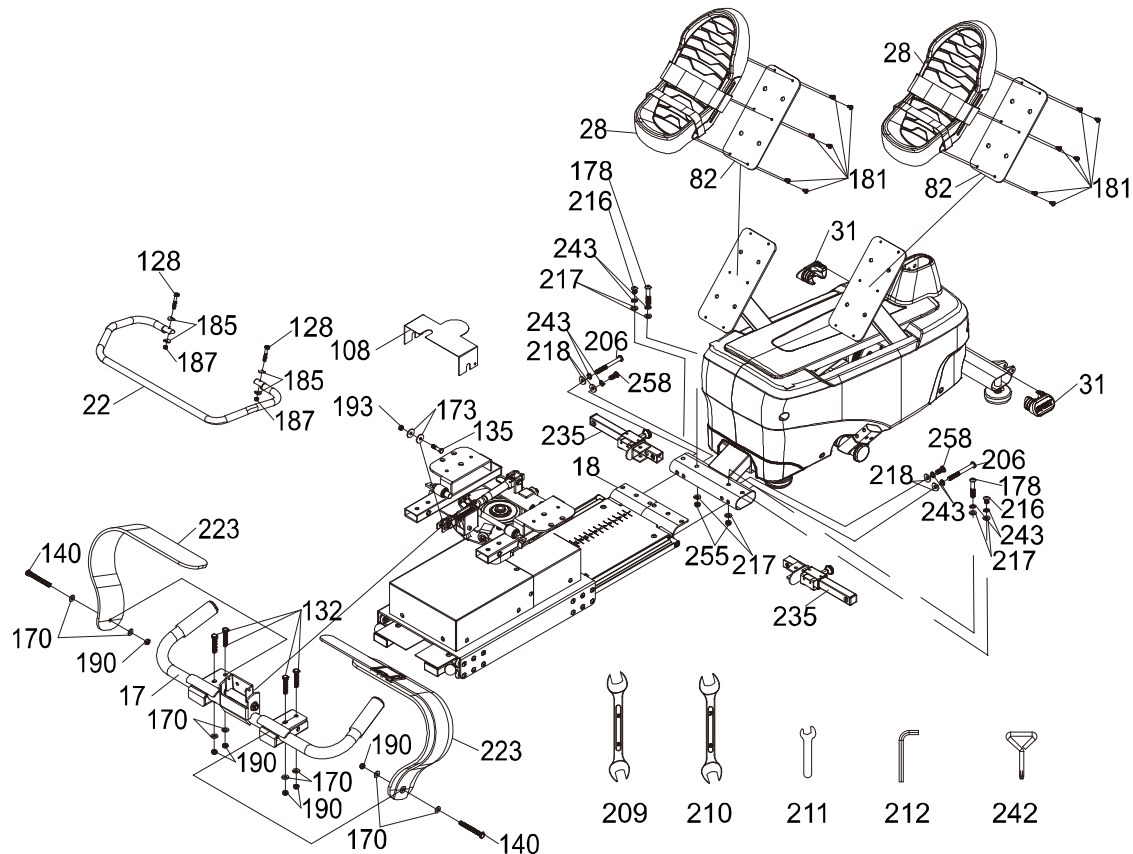

## STEP 2: CONSOLE MAST & TRANSPORT WHEELS ASSEMBLY

1. Install the transport wheels (77) using the 5/16" x 1-3/4" bolts (152) and 5/16" nylon nuts (193).
2. Slide the console mast cover (74) onto the console mast (2); be sure the cover orientation on the mast is correct otherwise it won't clip in place later.
3. Snake the computer cable through the console mast and slide the mast onto the receiving brackets. Make sure the cable does not get pinched in between the mast and bracket.
4. Fasten the mast with the two 3/8" x 2-1/2" bolts (154), 3/8" split washers (194) and 3/8" flat washers (170) from the left side of the mast and secure with the two 3/8" nylon nuts (190). Install the two 8mm x 16mm bolts (153) and curved washers (184) through the front and rear holes in the mast.
5. Install six M8 x 30mm bolts (196) from the top side of the armrest and assemble the six nuts (160).

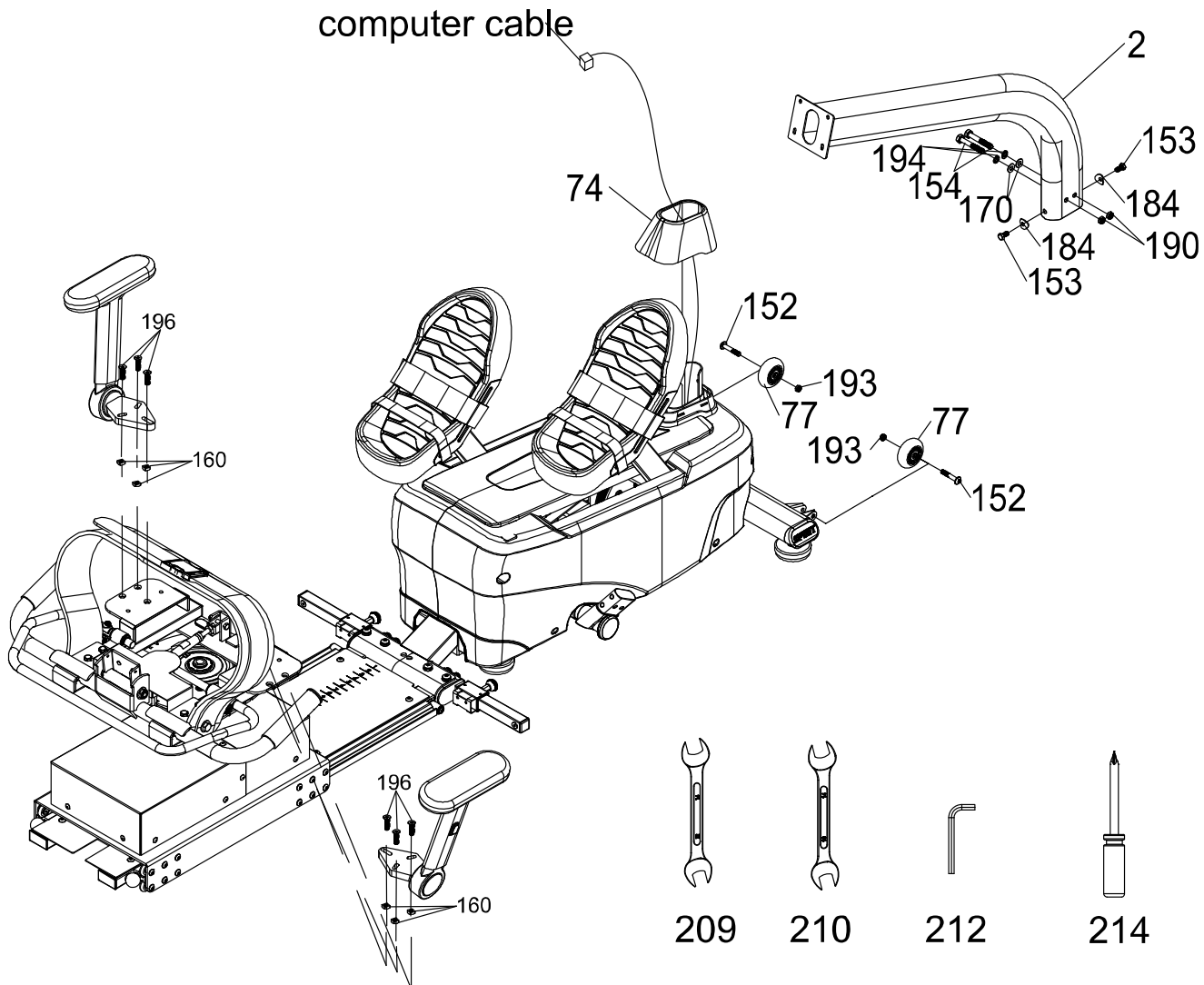

### STEP 3: SEAT BACK AND BOTTOM CUSHION ASSEMBLY

1. Slide the seat back assembly (94) into the seat back angle adjustment bracket and secure with the two 3/8" x 1-3/4" bolts (197), 3/8" washers (167) and 3/8" nuts (190).
2. Assemble the seat cushion (93) onto the seat frame with four M6 bolts (122).

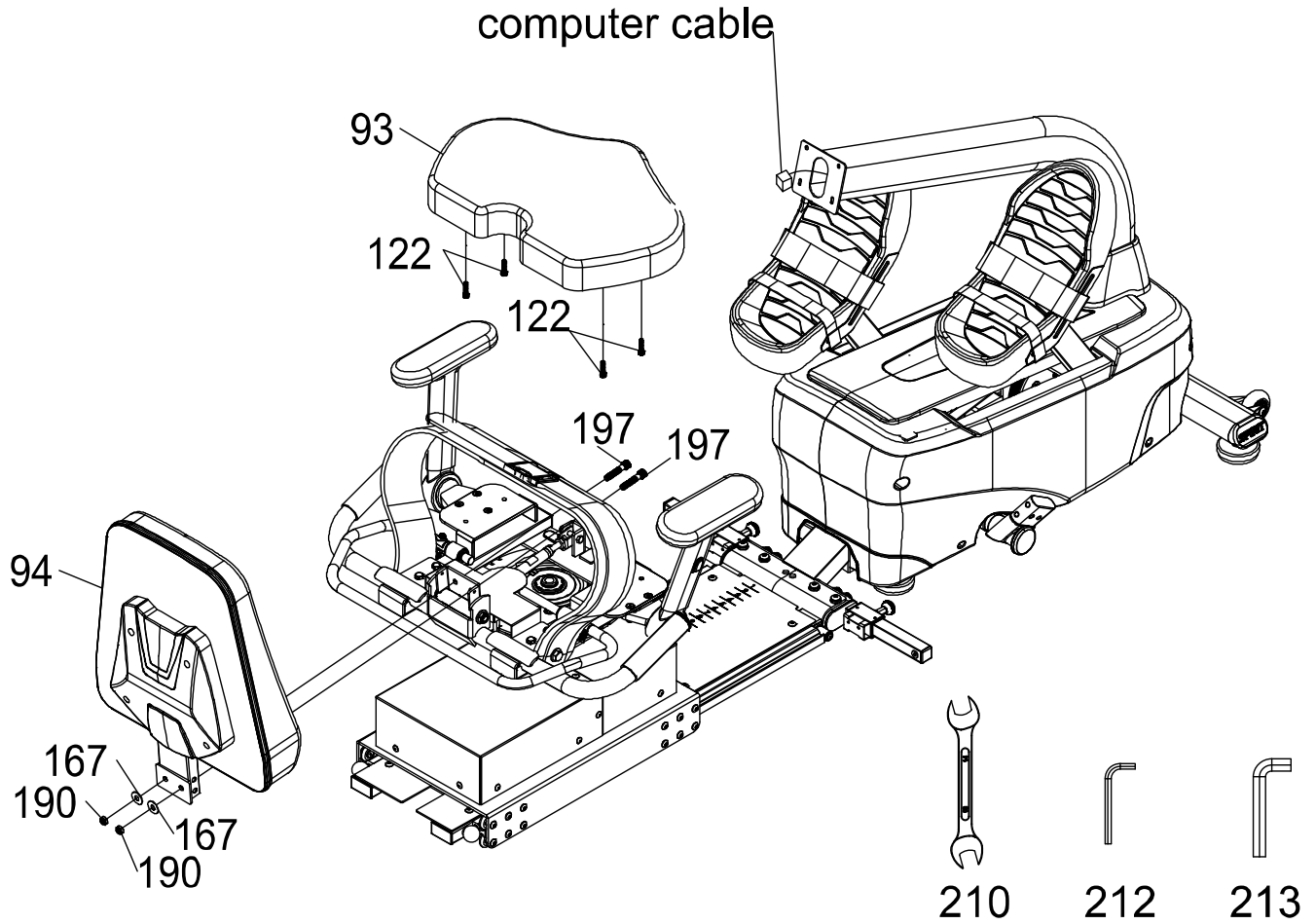



# MS350 Exploded View Drawing

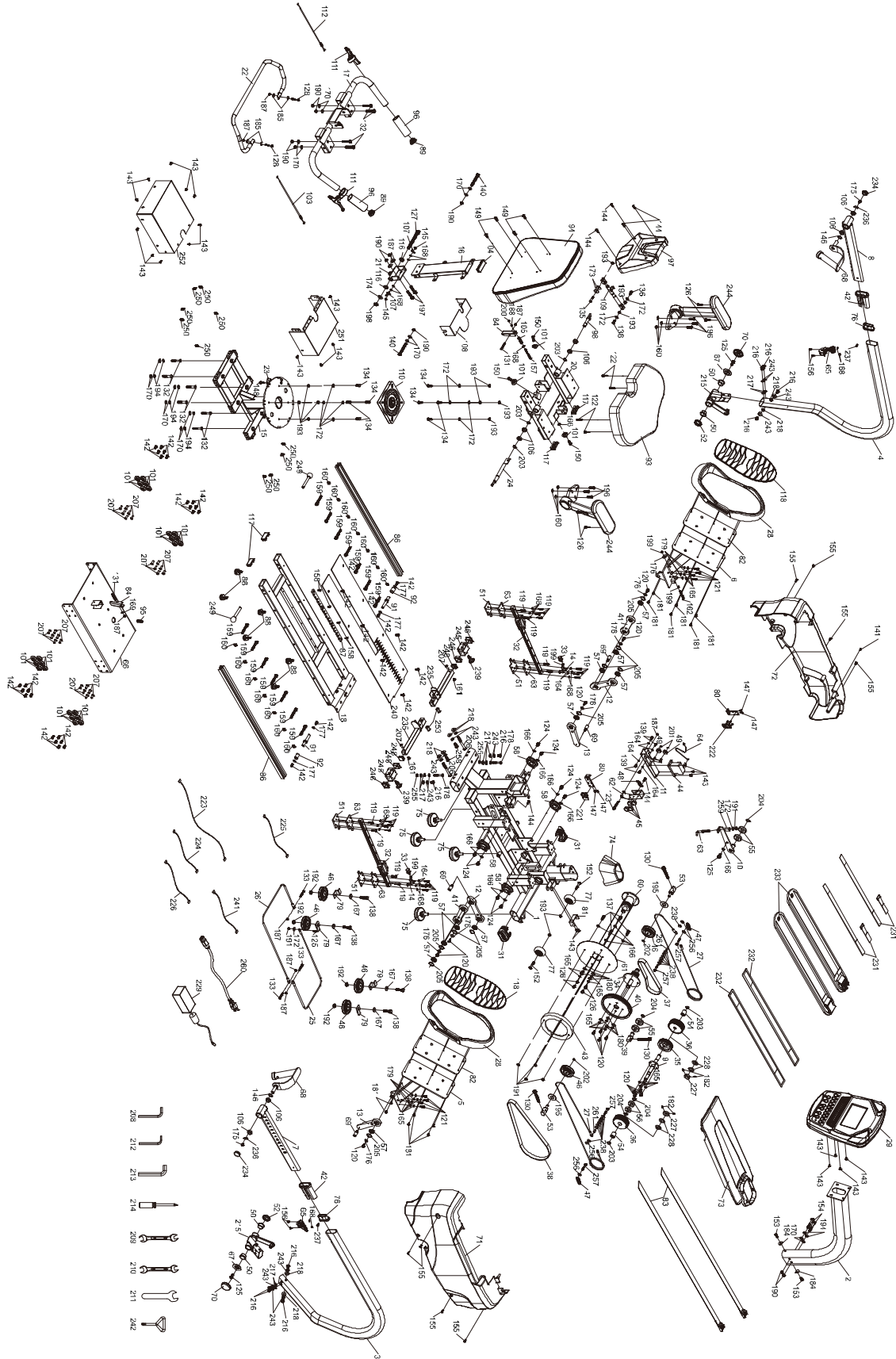

### **MS350 Parts List**

<b>Item#</b>	<b>Description</b>	<b>Qty.</b>
1	Main Frame	1
2	Console Mast	1
3	Swing Arm (R)	1
4	Swing Arm (L)	1
5	Pedal Plate (R)	1
6	Pedal Plate (L)	1
7	Handle Slider (R)	1
8	Handle Slider (L)	1
9	Drive Pulley axle	1
10	Idler Bracket	1
11	Brake Motor Bracket	1
12	Lower Linkage A	2
13	Lower Linkage B	2
14	Rubber Cushion Bracket	2
15	Seat Carriage	1
16	Seat Back Bracket	1
17	Handle Bar	1
18	Rail Base Frame	1
20	Rotate Seat Assembly	1
21	Seat Back Bracket	1
22	Seat Rotation Release Lever	1
23	Cantilever Anchor Assembly	1
24	Adjusting Lever	1
25	Front Connecting Cable	1
26	Rear Connecting Cable	1
27	Drive Cable	2
28	Pedal	2
29	Console Assembly	1
31	End Cap, Oval Stabilizer Tube	2
32	Linear Slider	2
33	M6 x Ø20 x 35L_Rubber Cushion	2
34	Ø100 x 134L_Passive Wheel	1
35	Ø80 x 22L_Drive Wheel	1
36	Ø84 x 32L_Cable Drive Pulley	2
37	Belt (8PJ), 584mm	1
38	Belt (8PJ), 1032mm	1
39	Adjustable Idler Wheel Axle	1
40	Drive Pulley	1
41	Lower Linkage	2

<b>42</b>	Slider Sleeve	2
<b>43</b>	Flywheel Mass	1
<b>44</b>	Gear Motor	1
<b>45</b>	Braking Magnet	4
<b>46</b>	Roller	6
<b>47</b>	Cable Spring(Ø15.5x26.5L)	2
<b>48</b>	Gear Motor Spring(Ø13x20L)	1
<b>49</b>	Steel Cable Roller(Ø6xØ24x7L)	2
<b>50</b>	WFM-2528-16_Plastic Bushing	4
<b>51</b>	Rubber Pad	4
<b>52</b>	Flywheel Axle Set Collar (R)	2
<b>53</b>	Cable Guide Wheel Axle	2
<b>54</b>	One Way Bearing	2
<b>55</b>	6203_Ball Bearing	4
<b>56</b>	6003_Ball Bearing	2
<b>57</b>	6902_Ball Bearing	10
<b>58</b>	Mounted Bearing	4
<b>60</b>	Aluminum Disc Drive Pulley	1
<b>61</b>	Aluminum Brake Disc	1
<b>62</b>	Magnet Bracket	1
<b>63</b>	Rubber Isolation Mount	4
<b>64</b>	Gear Motor Cable	1
<b>65</b>	Quick Release lever	2
<b>66</b>	Seat Carriage	1
<b>67</b>	Ø9 x Ø49 x 1.5T_Cup Washers	2
<b>68</b>	Handle	2
<b>69</b>	Axle	4
<b>70</b>	End Cap	2
<b>71</b>	Shroud (R)	1
<b>72</b>	Shroud (L)	1
<b>73</b>	Top Cover	1
<b>74</b>	Console Mast Cover	1
<b>75</b>	Ø75_Foot Leveler	4
<b>76</b>	Slide End Cap Spacer	2
<b>77</b>	Ø65_Transportation Wheel	2
<b>79</b>	Shroud Bracket	4
<b>80</b>	Sensor Bracket	2
<b>81</b>	Shroud Fixing Plate	1
<b>82</b>	Pedal Isolation Rubber	2
<b>83</b>	Fixing Belt	2
<b>84</b>	Seat Position Latch	2

<b>86</b>	Seat Slide Rail	2
<b>87</b>	Rack, Seat Position	1
<b>88</b>	Rubber Foot Pad	6
<b>89</b>	Ø32(1.8T)_Button Head Plug	2
<b>91</b>	Seat Stop Axle	2
<b>92</b>	Ø13 × Ø19 × 26.5L_Spacer for Stopper Axle	2
<b>93</b>	Seat Cushion	1
<b>94</b>	Seat Back	1
<b>95</b>	Ø13.5 × 30L_Spring	1
<b>96</b>	Handgrip Foam	2
<b>97</b>	Seat Back Cover	1
<b>98</b>	Adjusting Lever Rotate Axle(L)	1
<b>101</b>	PU Wheel	27
<b>103</b>	Steel Cable	1
<b>104</b>	Square End Cap	1
<b>105</b>	Ø13.5 × 60L_Spring	1
<b>106</b>	Powder Metal Sleeve(15.9x22mm)	8
<b>107</b>	Scale Arrowhead	2
<b>108</b>	Safety Cover	1
<b>109</b>	Locking Gas Cylinder	1
<b>110</b>	Rotate Disk	1
<b>111</b>	Release Lever	2
<b>112</b>	Steel Cable, Left (84.5x76cm)	1
<b>116</b>	Powder Metal Sleeve(Ø12xØ18x8L)	2
<b>117</b>	25m/m × 50m/m_Square End Cap	4
<b>118</b>	Pedal Foam Cushion	2
<b>119</b>	M5 × P0.8 × 25L_Socket Head Cap Bolt	24
<b>120</b>	M6 × P1.0 × 15L_Socket Head Cap Bolt	14
<b>121</b>	M6 × P1.0 × 20L_Socket Head Cap Bolt	8
<b>122</b>	M6 × P1.0 × 25L_Socket Head Cap Bolt	4
<b>123</b>	M6 × P1.0 × 55L_Socket Head Cap Bolt	1
<b>124</b>	M8 × P1.25 × 12L_Socket Head Cap Bolt	8
<b>125</b>	M8 × P1.25 × 20L_Socket Head Cap Bolt	4
<b>126</b>	M6 × P1.0 × 12L_Socket Head Cap Bolt	8
<b>127</b>	M12 × P1.75 × 120L_Socket Head Cap Bolt	1
<b>128</b>	M6 × P1.0 × 40L_Socket Head Cap Bolt	2
<b>130</b>	M10 × P1.5 × 75L_Socket Head Cap Bolt	3
<b>131</b>	M6 × P1.0 × 38L_Socket Head Cap Bolt	2
<b>132</b>	3/8" × UNC16 × 2" _Hex Head Bolt	10
<b>133</b>	M6 × P1.0 × 40L_Hex Head Bolt	3
<b>134</b>	5/16" × UNC18 × 3/4" _Hex Head Bolt	8



<b>135</b>	5/16" x UNC18 x 1-1/4_Hex Head Bolt	1
<b>136</b>	5/16" x 5/8" _Hex Head Bolt	2
<b>137</b>	M8 x P1.25 x 25L_Hex Head Bolt	4
<b>138</b>	M10 x P1.5 x 40L_Hex Head Bolt	4
<b>139</b>	M5 x P0.8 x 12L_Socket Head Cap Bolt	4
<b>140</b>	3/8" x UCN16 x 3-1/4" _Hex Head Bolt,20L	2
<b>141</b>	Ø3.5 x 12L_Phillips Head Self-Tapping Screw	1
<b>142</b>	M6 x 10L_Button Head Socket Bolt	36
<b>143</b>	M5 x P0.8 x 12L_Phillips Head Screw	23
<b>144</b>	M5 x P0.8 x 20L_Phillips Head Screw	6
<b>145</b>	M5 x P0.8 x 6L_Phillips Head Screw	2
<b>146</b>	Ø17_Wave Washer	2
<b>147</b>	M4 x P0.7 x 10L_Phillips Head Screw	4
<b>148</b>	5/16" x UNC18 x 3/4" _Hex Head Bolt	1
<b>149</b>	M8 x P1.25 x 20L_Button Head Socket Bolt	4
<b>150</b>	M8 x P1.25 x 25L_Button Head Socket Bolt	3
<b>152</b>	5/16" x UNC18 x 1-3/4" _Button Head Socket Bolt	2
<b>153</b>	M8 x P1.25 x 16L_Hex Head Bolt	2
<b>154</b>	3/8" x UNC16 x 2-1/2" _Hex Head Bolt	2
<b>155</b>	M5 x P0.8 x 12L_Phillips Head Screw	8
<b>156</b>	M5 x 6L_Phillips Head Screw	4
<b>157</b>	M5 x P0.8 x 70L_Phillips Head Screw	1
<b>158</b>	M5 x P0.8 x 12L_Flat Head Phillips Screw	4
<b>159</b>	M8 x 60L_Socket Head Cap Bolt	14
<b>160</b>	M8 x 1.25 x 6.5T_Luck Nut	20
<b>161</b>	M6 x 10L_Flat Head Phillips Screw	2
<b>162</b>	M6 x P1.0 x 57L_Eye Bolt	1
<b>163</b>	M8 x P1.25 x 80L_J Bolt	1
<b>164</b>	Ø5 x 1.5T_Split Washer	8
<b>165</b>	Ø6 x 1T_Split Washer	20
<b>166</b>	Ø8 x 1.5T_Split Washer	14
<b>167</b>	Ø10 x Ø25 x 2T_Flat Washer	6
<b>168</b>	Ø5 x Ø12 x 1.0T_Flat Washer	21
<b>169</b>	Ø1/4" x Ø13 x 1T_Flat Washer	1
<b>170</b>	Ø3/8" x Ø30 x 3.0T_Flat Washer	16
<b>172</b>	Ø8.5 x Ø18 x 1.5T_Flat Washer	12
<b>173</b>	Ø8.5 x Ø26 x 2.0T_Flat Washer	2
<b>174</b>	Ø1/2" x Ø26 x 2.0T_Flat Washer	1
<b>175</b>	M6 x P1.0 x 10L_Socket Head Cap Bolt	2
<b>176</b>	Ø6 x Ø19 x 3.0T_Flat Washer	7
<b>177</b>	Ø6 x Ø16 x 1.0T_Flat Washer	4

<b>178</b>	3/8" x UNC16 x 2-1/2"_Button Head Socket Bolt	2
<b>179</b>	Ø6.6 x Ø12 x 1.5T_Flat Washer	8
<b>180</b>	Ø1/4" x 19 x 1.5T_Flat Washer	8
<b>181</b>	M5 x P0.8 x 15L_Phillips Head Screw	12
<b>182</b>	M5 x P0.8 x 10L_Slotted Set Screw	4
<b>184</b>	Ø8 x 23 x 1.5T_Curved Washer	2
<b>185</b>	Ø5/16" x 19 x 1.5T_Curved Washer	4
<b>187</b>	M6 x P1.0 x 6T_Nyloc Nut	8
<b>188</b>	M5 x P0.8 x 5.0T_Nyloc Nut	1
<b>190</b>	3/8" x UNC16 x 7T_Nyloc Nut	10
<b>191</b>	M8 x P1.25 x 6T_Nyloc Nut	6
<b>192</b>	M10 x P1.5 x 8T_Nyloc Nut	4
<b>193</b>	5/16" x UNC18 x 6T_Nyloc Nut	13
<b>194</b>	Ø10 x 2T_Split Washer	8
<b>195</b>	Ø45 x Ø21.8 x 2.5T_Flat Washer	2
<b>196</b>	M8 x P1.25 x 30L_Flat Head Socket Screw	6
<b>197</b>	3/8" x UNC16 x 1-3/4"_Socket Head Cap Bolt	2
<b>198</b>	M12 x P1.75 x 8T_Nyloc Nut	1
<b>199</b>	M6 x P1.0 x 5T_Nut	4
<b>200</b>	M5 x P0.8 x 4T_Nut	1
<b>201</b>	E5_E-Clip	2
<b>202</b>	Ø10_C Ring	2
<b>203</b>	Ø16_C Ring	5
<b>204</b>	Ø17_C Ring	4
<b>205</b>	Ø28_Inner Snap Ring	10
<b>206</b>	3/8" x 3-3/4"_Button Head Socket Bolt	2
<b>207</b>	M6 x Ø8 x 19L_Nut	26
<b>208</b>	L Allen Wrench(6x27x120L)	1
<b>209</b>	12/14m/m_Wrench	1
<b>210</b>	13/14m/m_Wrench	1
<b>211</b>	Wrench, 10mm	1
<b>212</b>	L Allen Wrench(6x25x67L)	1
<b>213</b>	M8_L Allen Wrench	1
<b>214</b>	Phillips Head Screw Driver	1
<b>215</b>	Swing Arm Drive Weldment	2
<b>216</b>	3/8" x UNC16 x 5/8"_Button Head Socket Bolt	10
<b>217</b>	Ø3/8" x Ø19 x 2.0T_Flat Washer	10
<b>218</b>	Ø3/8" x Ø23 x 3.0T_Curved Washer	8
<b>221</b>	Optical Sensor Board(CS63008-00)	1
<b>222</b>	Optical Sensor Board(CS63008-10)	1
<b>223</b>	1550m/m_Computer Console Cable	1

<b>224</b>	250m/m_Encoder Cable	1
<b>225</b>	100m/m_DC Power Cord	1
<b>226</b>	650m/m_Hall Sensor Cable	1
<b>227</b>	Set Collar	2
<b>228</b>	Ø18 x Ø32 x 1.5T_Nylon Washer	4
<b>229</b>	Power Adapter, 12VDC	1
<b>231</b>	Foot Strap, Narrow	2
<b>232</b>	Foot Strap, Wide	2
<b>233</b>	Seat Belt	1
<b>234</b>	32 x 2.5T_Round End Cap	2
<b>235</b>	Track Assembly	2
<b>236</b>	Swivel Handle Range Limiter	2
<b>237</b>	Ø5 x 16L_Tapping Screw	2
<b>238</b>	Ø10 x 24 x 3T_Nylon Washer	14
<b>239</b>	Latch	2
<b>240</b>	Cover	1
<b>241</b>	100m/m_W/Cable	1
<b>242</b>	Short Phillips Head Screw Driver	1
<b>243</b>	Ø10 x 2T_Split Washer	16
<b>244</b>	Arm Rest	1
<b>245</b>	Strap Hold Down	2
<b>246</b>	Sleeve	4
<b>248</b>	Square End Cap	2
<b>249</b>	Step Up Frame Pop Pin	2
<b>250</b>	Plate	10
<b>251</b>	Front Cover	1
<b>252</b>	Rear Cover	1
<b>253</b>	M10 x 1.5L_Hex Blind Nut	2
<b>255</b>	3/8" x 11T_Nyloc Nut	2
<b>256</b>	Ø5/16" x 20 x 3.0T_Flat Washer	4
<b>257</b>	M8 x 10 x 30L_Bolt	4
<b>258</b>	M10 x P1.5 x 30L_Button Head Socket Bolt	2
<b>259</b>	Ø10 x 14 x 25.4L_Sleeve	1
<b>260</b>	Power Adapter Line Cord	1
<b>261</b>	Powder Metallurgy Sleeve	2

## Maintenance:

1. Wipe down all areas in the sweat path with a damp cloth after each use to prevent rust.
2. Check hand grips, seat cushions and foot pedals for signs of wear (once a month).
3. If a squeak, thump, clicking or rough feeling develops the main cause is most likely one of two reasons:
  - 1) The hardware was not sufficiently tightened during assembly. All bolts that were installed during assembly need to be tightened as much as possible. It may be necessary to use a larger wrench than the one provided if you cannot tighten the bolts sufficiently. I cannot stress this point enough; 90% of calls to the service department for noise issues can be attributed to hardware not being tightened enough.
4. If squeaks or other noises persist, check that the unit is properly leveled. See page 7 for leveling instructions.

## Maintenance Menu in console software:

The console has built in maintenance/diagnostic software. The software will allow you to change the console settings from English to Metric and turn off the beeping of the speaker when a key is pressed for example. To enter the Maintenance menu (may be called Engineering mode, depending on version) press and hold down the Start, Stop and Enter keys. Keep holding the keys down for about 5 seconds and the message window will display "Engineering mode". Press the enter button to access the menu below:

1. Key Test
2. LCD test
3. Functions >
  - Sleep mode – on
  - Pause mode - on (If pause mode is off then console will remain Paused indefinitely, unless Stop or Start is pressed again).
  - Odometer reset
  - Units – English or Metric
4. Service
  - Motor test
    - Runs resistance motor from level 1~20 and then 20~1.
    - Position sensor value is shown in STEPS data window.
  - Sensor Test
    - SPM window shows reflector sensor #1 signal (1 or 0)
    - CALORIES window shows reflector sensor #2 signal
    - TIME window show Left step position counter
    - STEPS window show Right step position counter
    - PULSE window show speed sensor signal (on or off)

## Error Messages

1. **EEPROM Error** – Solution for this is to replace the console (Note: this is the only error message)
2. **Motor Error – Press stop to enter idle mode** – This error means the motor that controls resistance did not respond as expected. If the error occurs press stop. The console will return to the idle mode. You can then use the console but there will be no resistance changes. You may try to disconnect the power to the MS350 for one minute and re-connect. This may solve the problem, but if it does not call service.

## **Troubleshooting**

Below are common problems and basic checks to solve them. If these tips do not solve your problem then call your local distributor for service.

### **1. No Power:**

- a. Make sure the A.C. outlet has power (90~240VAC) and the line cord is plugged in securely to the AC adapter.
- b. Check the connection of the DC power wire from the adapter where it enters the MS350.
- c. Make sure all connectors in back of the console are securely seated in place.

### **2. Console programs do not start**

- a. Perform Keypad test in Maintenance mode
- b. If you cannot access the test, and the keys seem to have no affect when pressed, then the keypad has malfunctioned.

### **3. Program starts but no data registers when MS350 is pedaled**

- a. Check that the connectors are properly seated in the back of the consoles.
- b. Perform the Sensor tests in Maintenance mode. If one of the sensors does not work it needs replacement. If both sensors do not work then it could be a bad console or both sensors are bad.

### **4. Symmetry and/or Watt measurement is incorrect**

- a. Perform the sensor tests in Maintenance Mode

### **5. Cannot adjust seat fore/aft or back angle, or seat adjustments will not lock in place**

- a. Adjust the thumb nuts located to the rear of the seat adjustment levers. If the cables attached to the levers stretch it is possible the latch for the seat will not disengage, or engage, properly. Adjusting the thumb nut can remedy this.

### **6. Clicking noise when pedaling**

- a. Make sure the pedal is tightened properly.
- b. Make sure the swing arms are securely tightened where they attach to the MS350,
- c. Check that the leveling feet on the bottom of the MS350 are adjusted properly.

### **7. One pedal has no resistance but the other does**

- a. The drive cable has jumped off of the pulley system.

## **Specifications:**

### **REF** MS350

**Dimensions:** Length = 80.3" (204cm), Width = 33.1" (84cm), Height = 46.9" (119cm)

**Weight:** 305.8 lbs. (139 kg)

**Patient weight capacity:** 440 lb. (200 kg)

**Input Power:** 12 VDC, 2.74 Amps

**External Power Supply:** Sinpro Model # HPU32A-105, 30 watt power supply

**Input:** 100-240V ~: 50/60 Hz: 0.6–0.4A

**Output:** 12 VDC, 2.74 A

**Input to Output:** 2MOPP

**Class II**

**Certification:** ANSI/AAMI ES 60601-1: 2005(UL/cUL 3rd Edition)  
EN 60601-1:2006 (TUV/T-mark 3rd Edition)

**Fuse Rating:** No user replaceable fuse.

**Resistance:** Isokinetic with 20 levels of effort.

**Work Load:** 5 watts up to 650 watts.

**Readouts:** Time and Segment time remaining, RPM, Watts (Left and Right), METs, Symmetry Index, Heart Rate, Calories, Work Level

**Certifications:** TUV listed to ANSI/AAMI ES60601-1:2005+A2 (R2012) +A1, CAN/CSA-C22.2 No. 60601-1:14, CE conformity to EN 60601-1 EMC, Compliance to EN 60601-1-2

**Classification:** Class II measuring, Type BF, ordinary equipment, continuous operation. This product is classed as ordinary equipment according to IEC/EN/UL60601-1 and is NOT protected against the ingress of water.

**Disposal:** Reference should be made to local regulations concerning the disposal of this product at the end of useful life.



Dyaco International Inc.  
12F, No.111, Songjiang Rd.  
Taipei 104, Taiwan R.O.C.



## Guidance and manufacturer's declaration – electromagnetic compatibility

The MS350 is intended for use in the electromagnetic environment specified below. The customer or the user of the MS350 should assure that it is used in such an environment.

Emissions test	Compliance	Electromagnetic environment – guidance	
RF emissions CISPR 11	Group 1	The MS350 uses RF energy only for its internal function. Therefore, its RF emissions are very low and are not likely to cause any interference in nearby electronic equipment.	
RF emissions CISPR 11	Class B	The MS350 is suitable for use in all establishments, including domestic establishments	
Immunity test	IEC 60601 test level	Compliance level	Electromagnetic environment – guidance
Electrostatic discharge (ESD) IEC 61000-4-2	6 kV contact 8 kV air	6 kV contact 8 kV air	Floors should be wood, concrete or ceramic tile. If floors are covered with synthetic material, the relative humidity should be at least 30 %.
Power frequency (50/60 Hz) magnetic field  IEC 61000-4-8	3 A/m	3 A/m	Power frequency magnetic fields should be at levels characteristic of a typical location in a typical commercial or hospital environment.
Radiated RF IEC 61000-4-3	3 V/m 80 MHz to 2,5 GHz	3 V/m	$d = 1,2 \sqrt{P}$ 80 MHz to 800 MHz $d = 2,3 \sqrt{P}$ 800 MHz to 2,5 GHz Where P is the maximum output power rating of the transmitter in watts (W) according to the transmitter manufacturer and d is the recommended separation distance in meters (m). Field strengths from fixed RF transmitters, as determined by an electromagnetic site survey, a) should be less than the compliance level in each frequency range. B) Interference may occur in the vicinity of equipment marked with the following symbol: 

### Recommended separation distances between portable and mobile RF communications equipment and the MS350

The MS350 is intended for use in an electromagnetic environment in which radiated RF disturbances are controlled. The customer or the user of the MS350 can help prevent electromagnetic interference by maintaining a minimum distance between portable and mobile RF communications equipment (transmitters) and the MS350 as recommended below, according to the maximum output power of the communications equipment.

Rated maximum output power of transmitter W	Separation distance according to frequency of transmitter		
	m		
	150 kHz to 80 MHz $d = 1,2 \sqrt{P}$	80 MHz to 800 MHz $d = 1,2 \sqrt{P}$	800 MHz to 2,5 GHz $d = 2,3 \sqrt{P}$
0,01	0,12	0,12	0,23
0,1	0,38	0,38	0,73
1	1,2	1,2	2,3
10	3,8	3,8	7,3
100	12	12	23

For transmitters rated at a maximum output power not listed above, the recommended separation distance  $d$  in meters (m) can be estimated using the equation applicable to the frequency of the transmitter, where  $P$  is the maximum output power rating of the transmitter in watts (W) according to the transmitter manufacturer.

NOTE 1 At 80 MHz and 800 MHz, the separation distance for the higher frequency range applies.

NOTE 2 These guidelines may not apply in all situations. Electromagnetic propagation is affected by absorption and reflection from structures, objects and people.

Immunity test	IEC 60601 test level	Compliance level	Electromagnetic environment – guidance
Electrical fast transient/burst IEC 61000-4-4	+/-2 kV for power supply lines +/-1 kV for input/output lines	+/-2 kV for power supply lines +/-1 kV for input/output lines	Mains power quality should be that of a typical commercial or hospital environment.











**Note:**

- If the device is interfered by power or signal cable, image quality may be reduced or abnormally displayed. Such kind of interference images could be easily identified and differentiated from the physiological characteristics of patient and longer clinical time consumed but wouldn't have any diagnostic accuracy issue.
- If there is a certain frequency of image interference, there is a need of isolation or filtering of the RF signal.



## Description of Packaging Symbols

Symbols	Illustration
	<p>Indicates that the package is heavy and two or more people are required to lift.</p>
	<p>The broken wine glass suggests that the product inside the packaging could be easily damaged if dropped or handled without care and attention. The contents are fragile!</p>
	<p>Package contains fragile electronic equipment. Care should be used when handling.</p>
	<p>Do not use forklift truck here.</p>
	<p>Do not use Spade truck here.</p>
	<p>Hand truck only.</p>
	<p>Do not use Razorback truck here.</p>
	<p>Indicates that an object is capable of being recycled - not that the object has been recycled or will be accepted in all recycling collection systems.</p>
	<p>Top. This side up.</p>

# ***Manufacturer's Limited Warranty***

Dyaco Canada Inc. warrants all its bike parts for a period of time listed below, from the date of retail sale, as determined by a sales receipt or in the absence of a sales receipt. Dyaco Canada Inc.'s responsibilities include providing new or remanufactured parts, at Dyaco Canada Inc.'s option, and technical support to our independent dealers and servicing organizations. In the absence of a dealer or service organization, these warranties will be administered by Dyaco Canada Inc. directly to a consumer. The warranty period applies to the following components:

## **Warranty**

**Frame: Lifetime**

**EMS Brake: 5 years**

**Parts and Labour: 3 years**

This warranty is not transferable and is extended only to the original owner.

The warranty shall not apply to exercise units which are subject to misuse, neglect, accident or unauthorized repair and alterations.

This warranty provided herein is lieu of all other express warranties, any implied warranties, including any implied warranties of merchantability of fitness for particular purpose, are limited in duration to the first 36 months from date of purchase. All other obligations or liabilities, including liability for consequential damages are hereby excluded.

## **REPAIR PARTS AND SERVICE**

All of the parts for the Spirit unit shown in figure can be ordered from Dyaco Canada Inc. 5955 DON MURIE STREET, NIAGARA FALLS, ONTARIO L2G 0A9. When ordering parts, the parts will be sent and billed at the current prices. Prices may be subject to change without notice. Check or money order must accompany all orders. Standard hardware items are available at your local hardware store.

To ensure prompt and correct handling of any errors, or to answer any questions, please call our Toll Free number: 1-888-707-1880, or local number 1-905-353-8955 or fax 1-905-353-8968, email [customerservice@dyaco.ca](mailto:customerservice@dyaco.ca) or visit our website at [www.dyaco.ca](http://www.dyaco.ca). Office hours are from 8:30 AM to 5:00 PM Monday to Friday Eastern Standard Time.

Always include the following information when ordering parts

- Model number
- Name of each part
- Part number of each part



Please visit us online for information about our other brands and products manufactured and distributed by Dyaco Canada Inc.



[www.dyaco.ca](http://www.dyaco.ca)



[www.dyaco.ca](http://www.dyaco.ca)



[www.dyaco.ca](http://www.dyaco.ca)



[www.dyaco.ca](http://www.dyaco.ca)



[www.spiritfitness.ca](http://www.spiritfitness.ca)  
[www.dyaco.ca](http://www.dyaco.ca)



[www.spiritmedical.ca](http://www.spiritmedical.ca)  
[www.dyaco.ca](http://www.dyaco.ca)



[www.solefitness.ca](http://www.solefitness.ca)  
[www.dyaco.ca](http://www.dyaco.ca)



[www.trainorsports.ca](http://www.trainorsports.ca)  
[www.dyaco.ca](http://www.dyaco.ca)



[www.xterrafitness.ca](http://www.xterrafitness.ca)  
[www.dyaco.ca](http://www.dyaco.ca)