

Owner's Manual

Model No.
16207683550
XBR55

- Assembly
- Operation
- Adjustments
- Parts
- Warranty

CAUTION:
Read and
understand this
manual before
operating unit

SPIRIT



Retain For Future Reference

TABLE OF CONTENTS

Product Registration.....	2
Important Safety Instructions.....	3
Important Electrical Instructions.....	4
Important Operation Instructions.....	5
Assembly Instructions.....	6
Operation of Your Recumbent Bike.....	11
Using the Spirit FIT App	15
Programmable Features.....	16
Using Heart Rate Transmitter.....	22
Exploded View Diagram	24
Parts List.....	25
General Maintenance.....	30
Manufacturer’s Limited Warranty.....	31

ATTENTION

This Fitness Bike is intended for residential use only and is warranted for this application. Any other application voids this warranty in its entirety.

SPIRIT

CONGRATULATIONS ON YOUR NEW FITNESS BIKE

Thank you for your purchase of this quality fitness bike trainer from Dyaco Canada Inc. Your new bike was manufactured by one of the leading fitness manufacturers in the world and is backed by one of the most comprehensive warranties available. Through your dealer, Dyaco Canada Inc. will do all we can to make your ownership experience as pleasant as possible for many years to come. The local dealership where you purchased this bike is your administrator for all Dyaco Canada Inc. warranty and service needs. Their responsibility is to provide you with the technical knowledge and service personnel to make your experience more informed and any difficulties easier to remedy.

Please take a moment at this time to record the name of the dealer, their telephone number, and the date of purchase below to make any future, needed contact easy. We appreciate your support and we will always remember that you are the reason that we are in business. Please complete and mail your registration card today and enjoy your new bike.

Name of Dealer _____
Dealer Phone # _____
Purchase Date _____

Product Registration

RECORD YOUR SERIAL NUMBER

Please record the Serial Number of this fitness product in the space provided below.

Serial Number _____

REGISTER YOUR PURCHASE

The self-addressed product registration card must be completed in full and returned to Dyaco Canada Inc.

IMPORTANT SAFETY INSTRUCTIONS

THIS UNIT IS INTENDED FOR HOUSEHOLD USE ONLY
READ ALL INSTRUCTIONS BEFORE USING THIS FITNESS BIKE

When using an electrical appliance, basic precautions should always be followed, including the following:

WARNING - Read all instructions before using this appliance.

DANGER - To reduce the risk of electric shock disconnect your Spirit Fitness fitness bike from the electrical outlet prior to cleaning and/or service work.

WARNING - To reduce the risk of burns, fire, electric shock, or injury to persons, install the fitness bike on a flat level surface with access to a 110-volt, 15-amp grounded outlet with only the fitness bike plugged into the circuit.

DO NOT USE AN EXTENSION CORD UNLESS IT IS A 14 AWG OR BETTER, WITH ONLY ONE OUTLET ON THE END.

WARNING - To reduce the risk of burns, fire electric shock, or injury to persons:

1. An appliance should never be left unattended when plugged in. Unplug from outlet when not in use, and before putting on or taking off parts.
2. Do not operate under blanket or pillow. Excessive heating can occur and cause fire, electric shock, or injury to persons.
3. Close supervision is necessary when this appliance is used by, on, or near children, invalids, or disabled persons.
4. Use this appliance only for its intended use as described in this manual. Do not use attachments not recommended by the manufacturer.
5. Never operate this appliance if it has a damaged cord or plug, if it is not working properly, if it has been dropped or damaged, or dropped into water. Return the appliance to a service center for examination and repair.
6. Do not carry this appliance by supply cord or use cord as a handle.
7. Keep the cord away from heated surfaces.
8. Never operate the appliance with the air openings blocked. Keep the air openings free of lint, hair, and the like.
9. Never drop or insert any object into any opening.
10. Do not use outdoors.
11. Do not operate where aerosol (spray) products are being use or where oxygen is being administered.
12. Connect this appliance to a properly grounded outlet only.
13. The appliance is intended for household use

FITNESS EQUIPMENT SAFETY INSTRUCTIONS

- To disconnect turn all controls to the off position, then remove the plug from the outlet.
- Do not operate equipment on deeply padded, plush or shag carpet. Damage to both carpet and equipment may result.
- Before beginning this or any exercise program, consult a physician. This is especially important for persons over the age of 35 or persons with pre-existing health conditions.
- Do not attempt to use your equipment for any purpose other than for the purpose it is intended.
- Keep hands away from all moving parts.
- The pulse sensors are not medical devices. Their purpose is to provide you with an approximate measurement in relation to your target heart rate. Use of a chest transmitter strap is a much more accurate method of heart rate analysis. Various factors, including the user's movement, may affect the accuracy of heart rate readings. The pulse sensors are intended only as exercise aids in determining heart rate trends in general.
- Wear proper shoes. High heels, dress shoes, sandals or bare feet are not suitable for use on your equipment. Quality athletic shoes are recommended to avoid leg fatigue.

Failure to follow all guidelines may compromise the effectiveness of the exercise experience, expose yourself (and possibly others) to injury, and reduce the longevity of the equipment.

SAVE THESE INSTRUCTIONS - THINK SAFETY!

IMPORTANT ELECTRICAL INSTRUCTIONS

WARNING!

NEVER Remove any cover without first disconnecting AC power. If voltage varies by ten percent (10%) or more, the performance of your fitness bike may be affected. Such conditions are not covered under your warranty. If you suspect the voltage is low, contact your local power company or a licensed electrician for proper testing.

NEVER expose this fitness bike to rain or moisture. This product is NOT designed for use outdoors, near a pool or spa, or in any other high humidity environment. The operating temperature specification is 40 to 120 degrees Fahrenheit, and humidity is 95% non-condensing (no water drops forming on surfaces).

Circuit Breakers: Some circuit breakers used in homes are not rated for high inrush currents, (ARC fault breakers are one example) that can occur when a Fitness Bike is first turned on or even during use. If your Fitness Bike is tripping the house circuit breaker (even though it is the proper current rating) but the circuit breaker on the Fitness Bike itself does not trip, you will need to replace the home breaker with a high inrush type. This is not a warranty defect. This is a condition we as a manufacture have no ability to control. This part is available through most electrical supply stores. Examples: Grainger part # 1D237, or available online at www.squared.com part # QO120HM.

Grounding Instructions

This product must be grounded. If it should malfunction or breakdown, grounding provides a path of least resistance for electric current to reduce the risk of electric shock. This product is equipped with a cord having an equipment-grounding conductor and a grounding plug. The plug must be plugged into an appropriate outlet that is properly installed and grounded in accordance with all local codes and ordinances. See diagram below for grounding methods.

Figure 1.
Grounding methods

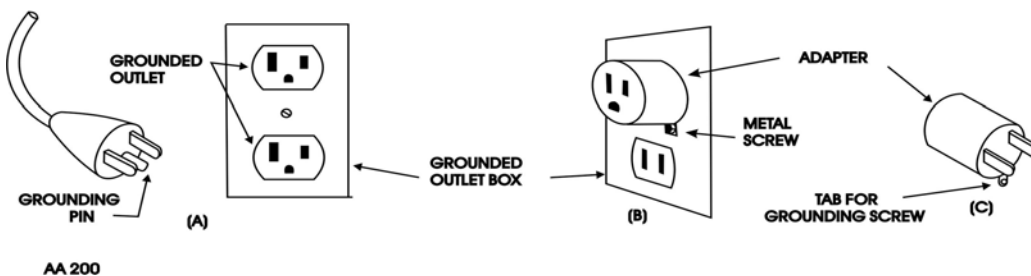

IMPORTANT OPERATION INSTRUCTIONS

- **NEVER** operate this fitness bike without reading and completely understanding the results of any operational change you request from the computer.
- Understand that changes in resistance do not occur immediately. Set your desired resistance level on the computer console and release the adjustment key. The computer will obey the command gradually.
- **NEVER** use your fitness bike during an electrical storm. Surges may occur in your household power supply that could damage fitness bike components. Unplug the fitness bike during an electrical storm as a precaution.
- Use caution while participating in other activities while pedaling on your fitness bike; such as watching television, reading, etc. These distractions may cause you to lose balance which may result in serious injury.
- Do not use excessive pressure on console control keys. They are precision set to function properly with little finger pressure.

ASSEMBLY INSTRUCTIONS

Pre-Assembly

1. Using a razor knife (Box Cutter), cut the banding straps that wrap around the carton. Reach under the bottom edge of the carton and pull it away from the cardboard underneath, separating the staples that join the two together. Lift the box over the unit and unpack.
2. Carefully remove all parts from carton and inspect for any damage or missing parts. If damaged parts are found, or parts are missing, contact your dealer immediately.
3. Locate the hardware package. The hardware is separated into four steps. Remove the tools first. Remove the hardware for each step as needed to avoid confusion. The numbers in the instructions that are in parenthesis (#) are the item number from the assembly drawing for reference.

ASSEMBLY TOOLS

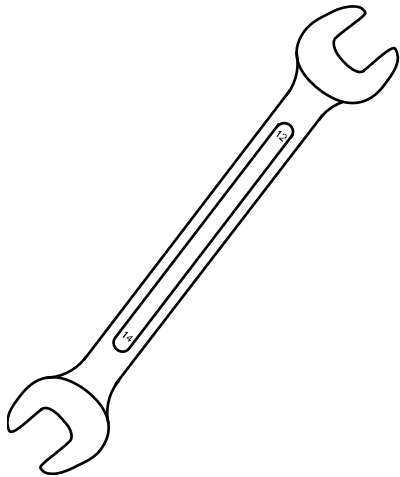

#112. 12/14mm Wrench

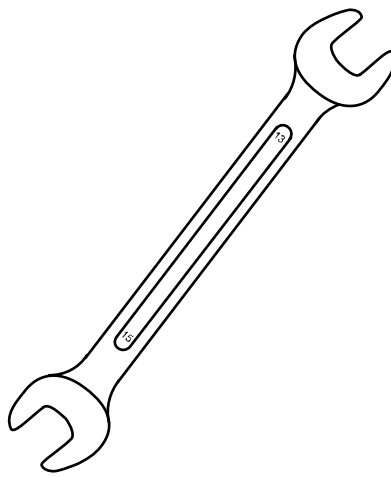

#113. 13/15mm Wrench

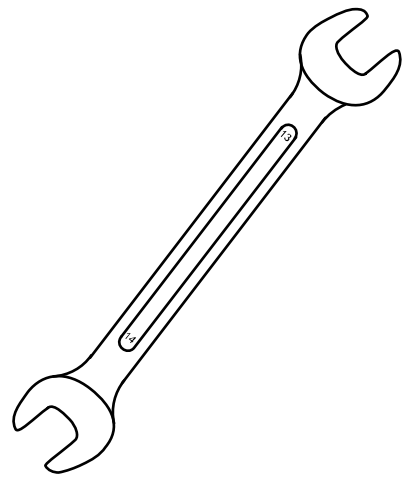

#130. 13/14mm Wrench

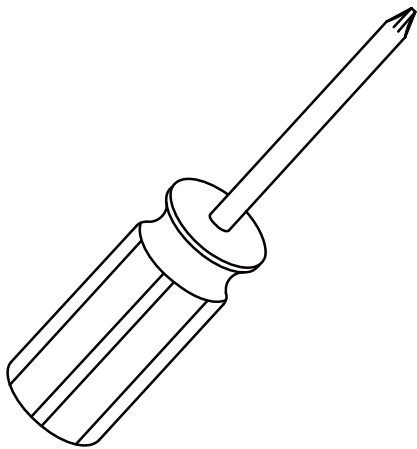

#114. Phillips Head Screwdriver

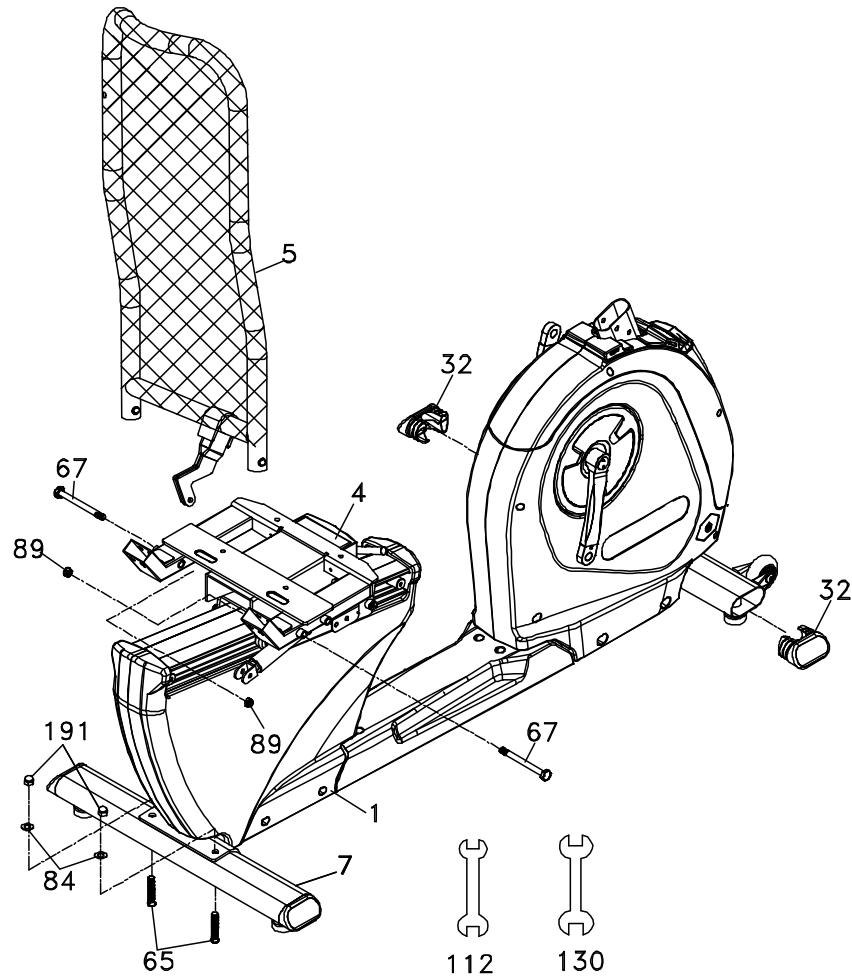

STEP 1: Rear Stabilizer & Seat Back

1. Attach the Rear Stabilizer (7) to the Main Frame (1) with the two Carriage Bolts (65) and two Flat Washers (84) and two Cap Nuts (191). Tighten completely with the Wrench (112).
2. Attach the Back Rest (5) to the Seat Carriage (4) of the main frame. Slide a Hex Head Bolt (67) through each side, then attach a Nyloc Nut (89) to each bolt. Tighten the bolts just enough so there is no side to side play, but freedom of movement front to back. Use the Wrenches provided (112 & 130).
3. Insert an end cap (32) into each opening of the Front Stabilizer Tube. You may need to tap them in with a rubber mallet if they are tight.

HARDWARE

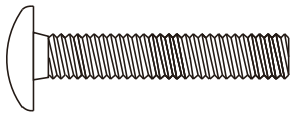

#65. 3/8" x 53mm
Carriage Bolt (2 pcs)

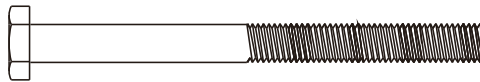

#67. 3/8" x 4"
Hex Head Bolt (2 pcs)



#89. 3/8" x 7T
Nyloc Nut (2 pcs)

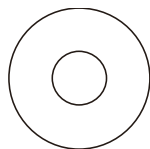

#84. 3/8" x 25 x 2T
Flat Washer (2 pcs)



#191. 3/8" x 12.5T
Cap Nut (2 pcs)

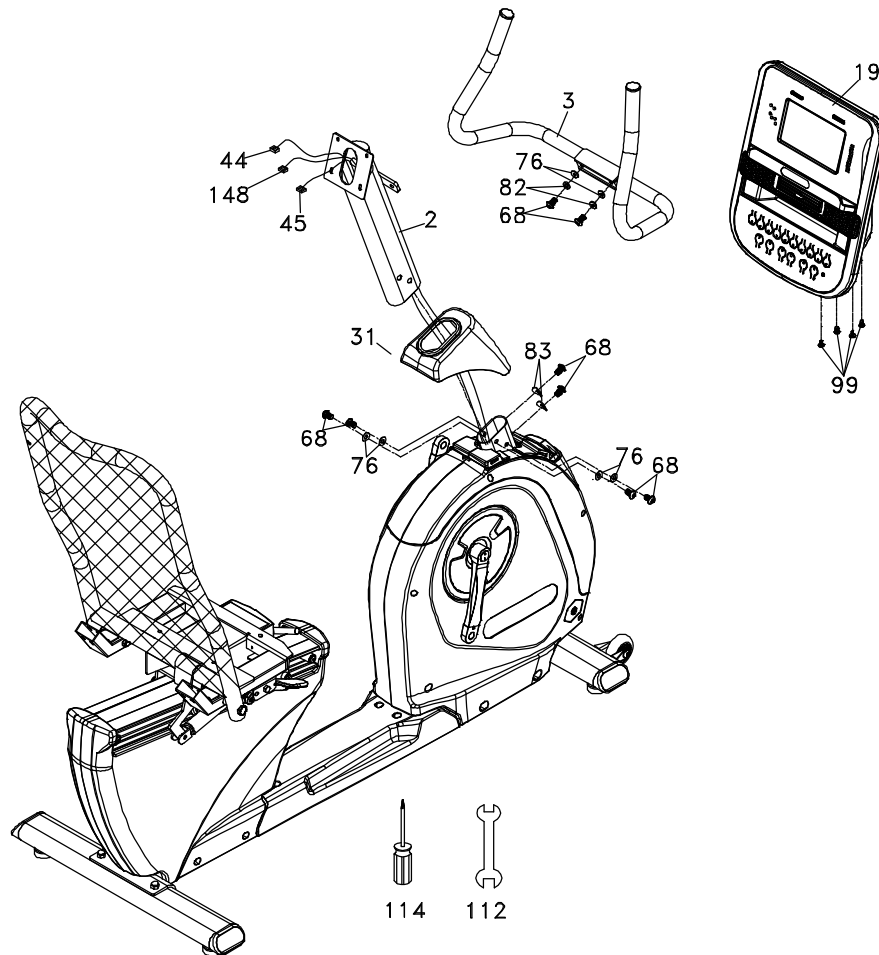

STEP 2: Console Mast

1. Slide the Computer Cable (**44**), Handlebar resistance control cable (**148**), and Hand Pulse Cable (**45**) through the bottom of the Console Mast Cover (**31**) and then the bottom of the Console Mast (**2**). Make sure the Console Mast Cover is correctly oriented.
2. Install the Console Mast (**2**) into the receiving tube (make sure not to pinch cables; damage to the electronics could occur) of the Main Frame (**1**). Insert two Hex Head Bolts (**68**) and two Flat Washers (**76**) on each side. Insert two Hex Head Bolts (**68**) and two Curved Washers (**83**) on the front. Tighten all six bolts firmly with the Wrench (**112**).
3. Remove the white styrofoam pad (factory installed to prevent bolts from being accidentally dropped into the Console Mast Tube).
4. Attach the Handlebar Assembly (**3**) onto the Console Mast (**2**) bracket with the two Hex Head Bolts (**68**), two Split Washers (**82**), and two Flat Washers (**76**). Completely tighten with the Wrench (**112**).
5. Insert the Computer Cable (**44**), Handlebar resistance control cable (**148**), and Hand Pulse Cable (**45**) into their respective connectors in the back of the Console Assembly (**19**). Attach the console onto the mounting plate with four Phillips Head Screws (**99**). Tighten with the Phillips Head Screwdriver (**114**).

HARDWARE

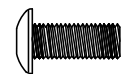
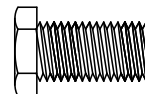
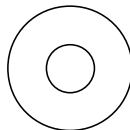
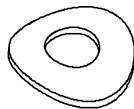

#82. 5/16" x 1.5T
Split Washer
(2 pcs)

#83. 5/16" x 19 x 1.5T
Curved Washer
(2 pcs)

#76. 5/16" x 18 x 1.5T
Flat Washer
(6 pcs)

#68. 5/16" x 5/8"
Hex Head Bolt
(8 pcs)

#99. M5 x 12mm
Phillips Head Screw
(4 pcs)

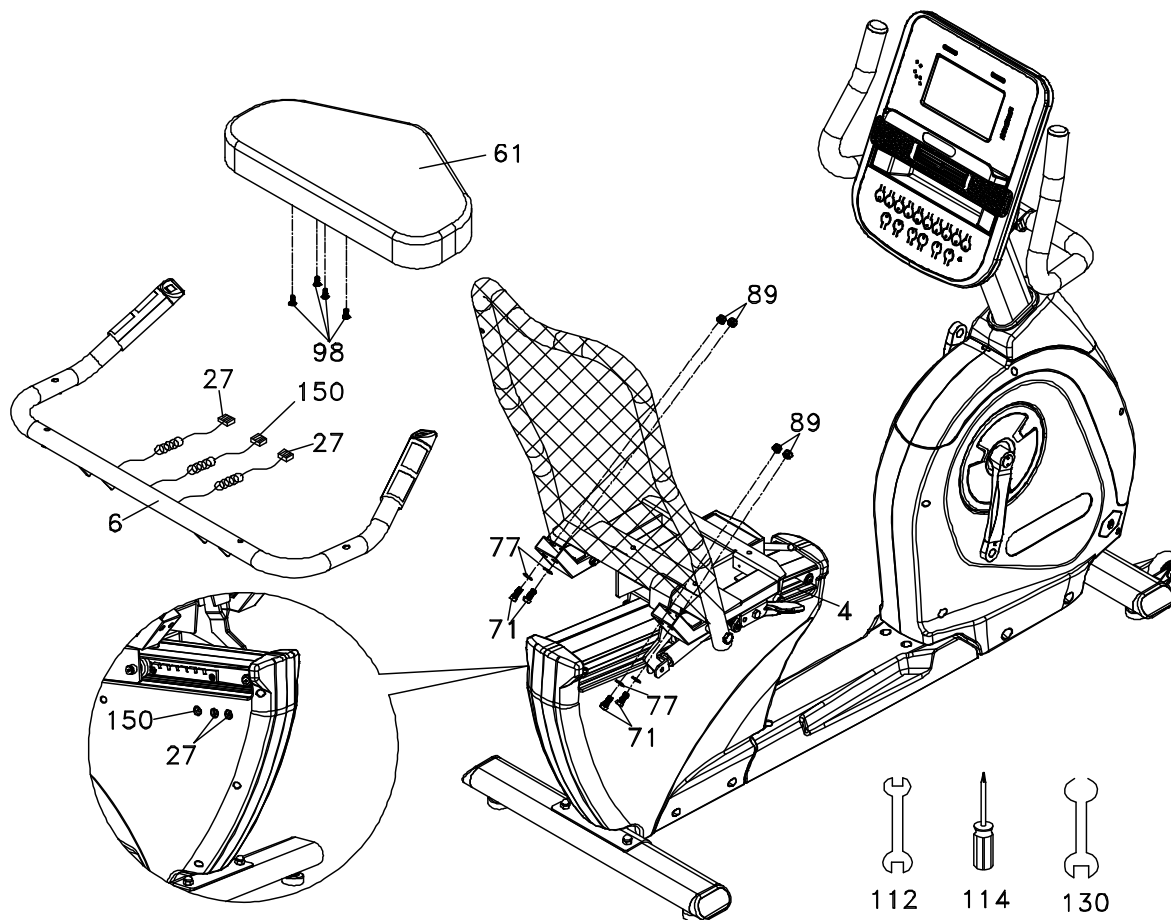

STEP 3: Seat & Handle Bar

1. Install the Seat (61) on the Seat Carriage (4) with four Phillips Head Screws (98). Tighten with the Phillips Head Screw Driver (114).
2. Attach the Seat Handle Bar (6) to the Seat Carriage (4) with the four Hex Head Bolts (71), four Flat Washers (77), and four Nyloc Nuts (89). Tighten with the Wrenches provided (112 & 130).
3. Plug the Hand Pulse Sensor Cables (27) into the rear two holes on the left side of the rear plastic cover. Plug the Handlebar Resistance Connecting Cable (150) into the remaining front hole.

HARDWARE



#98. M6 x 15mm
Phillips Head
Screw
(4 pcs)



#89. 3/8" x 7T
Nyloc Nut
(4 pcs)

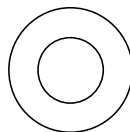

#77. 3/8" x 19 x 1.5T
Flat Washer
(4 pcs)



#71. 3/8" x 1-3/4"
Hex Head Bolt
(4 pcs)

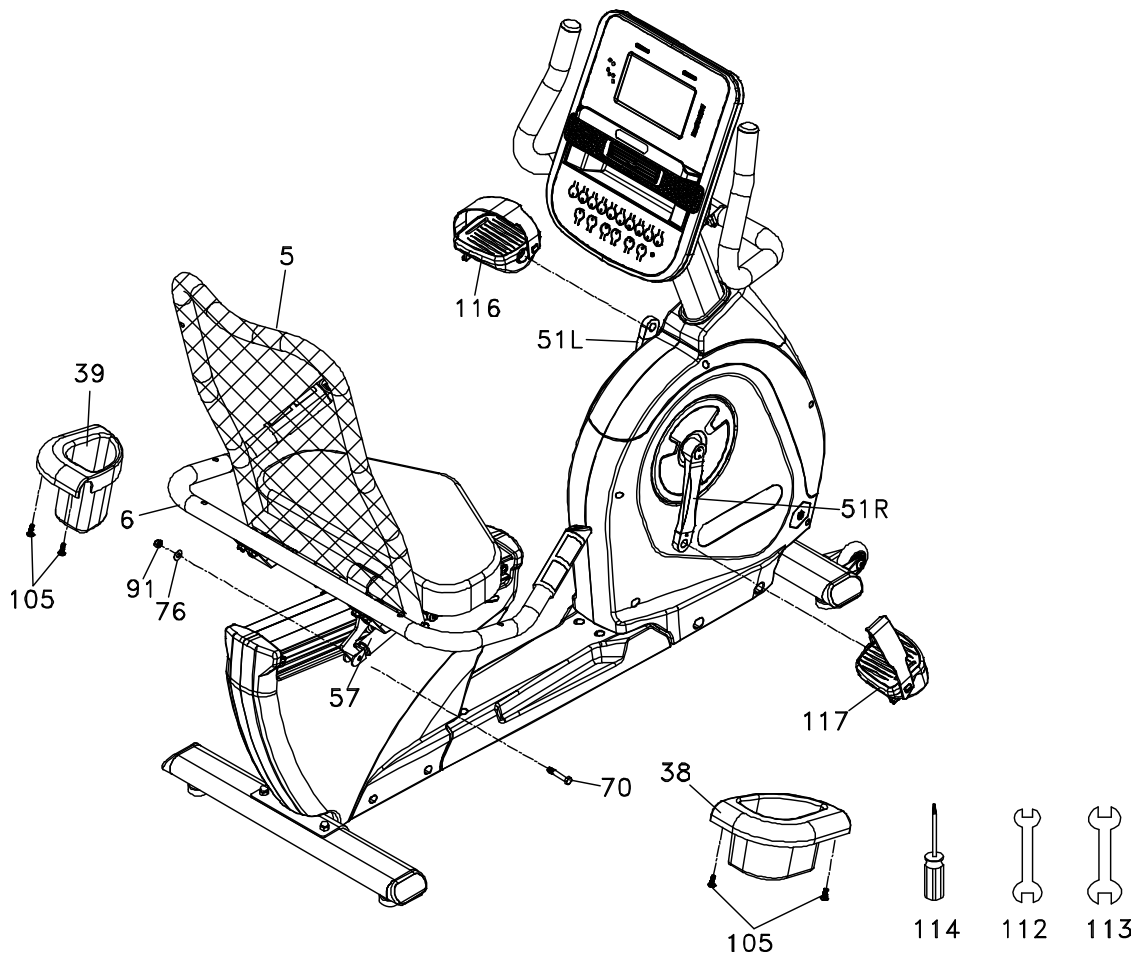

STEP 4: Plastic Parts

1. Install the **GAS CYLINDER (57)** on the **BACK REST (5)** with 1 **HEX HEAD BOLT (70)**, 1 **FLAT WASHER (76)** and 1 **NYLOC NUT (91)** by using the **WRENCHES** provided (**112 & 113**).
2. Attach the Pedals (**116L, 117R**) to the Crank Arms (**51L, 51R**). Tighten with the Wrench (**113**). Remember that the left pedal has a reverse thread and will be threaded onto the Crank arm in a counterclockwise motion. There is an "L" stamped in the end of the threaded post of the left pedal and an "R" in the right. Make sure to tighten the pedals as firmly as you can. It may be necessary to re-tighten the pedals if you feel a thumping while pedaling the bike. A thumping or clicking noise is usually caused by loose pedals.
3. Attach the Drink Bottle Holders (**39L & 38R**) to the sides of the Seat Handle Bar (**6**) with four Sheet Metal Screws (**105**). Tighten with the Phillips Head Screwdriver (**114**).

HARDWARE

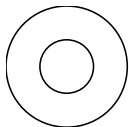

#76. 5/16" x 18 x 1.5T
Flat Washer
(1 pc)



#91. 5/16" x 6T
Nyloc Nut
(1 pc)



#105. Ø4 x 16 mm
Sheet Metal Screws
(4 pc)

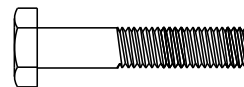

#70. 5/16" x 1-1/4"
Hex Head Bolt
(1 pc)

OPERATION OF YOUR FITNESS BIKE

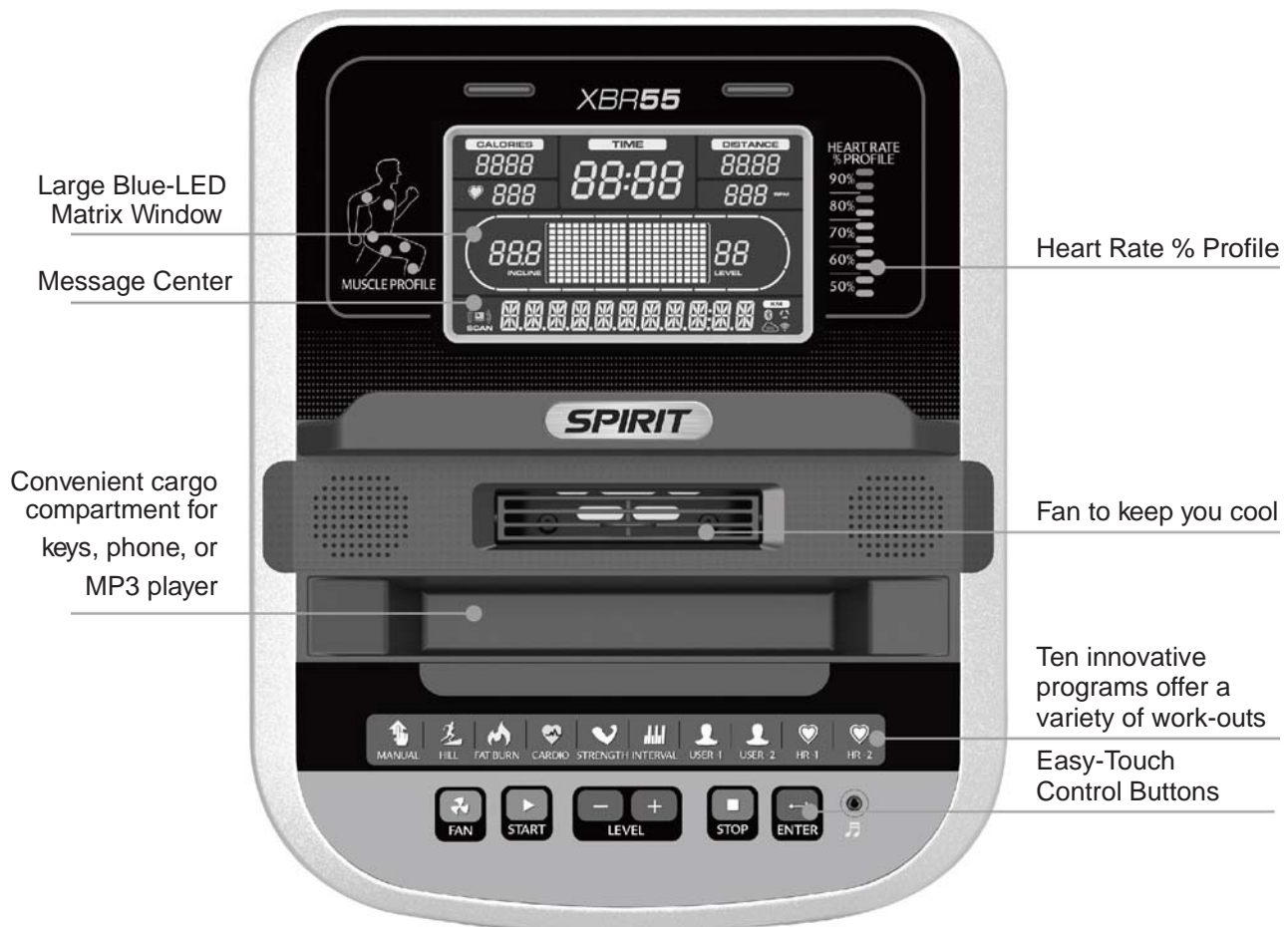

Power

When the power cord is connected to the equipment, the console will automatically Power up.

When initially powered on the console will perform an internal self-test. During this time all the lights will turn on. When the lights go off, the Message Center will show the software version (i.e.: VER 1.0). The distance window shows the distance in miles and the time window shows the total hours of use.

The odometer will remain displayed for only a few seconds then the console will go to the start up display. The dot matrix display will be scrolling through the different profiles of the programs and the Message Center will be scrolling the start up message. You may now begin to use the console.

Dot Matrix Center Display

Twenty columns of boxes (10 high) indicate each segment of a workout. The boxes only show an approximate level (resistance) of effort. They do not necessarily indicate a specific value - only an approximate percent to compare levels of intensity. In Manual Operation the resistance dot matrix window will build a profile "picture" as values are changed during a workout.

1/4 Mile Track

The 1/4-mile track (one lap) will be displayed around the dot matrix window. The flashing segment indicates your progress. Once the 1/4-mile (Metric - 0.4k) is complete this feature will begin again. The Lap track will move in a counterclockwise direction. *There is a lap counter in the Message Center for monitoring your distance.*

Pulse Grip Feature

The Pulse (Heart Rate) console window will display your current heart rate in beats per minute during the workout. You must use both stainless steel sensors on the front cross bar or the heart rate transmitter chest strap to display your pulse. Pulse value displays anytime the upper display is receiving a Pulse signal. You may not use the Grip Pulse feature while in Heart Rate Programs.

Calorie Display

Displays the cumulative calories burned at any given time during your workout.

Note: This is only a rough guide used for comparison of different exercise sessions, which cannot be used for medical purposes.

Speakers

The console has built-in Speakers. You may plug an Audio Source (CD player, MP3, Computer, etc.) into the Jack on the right side of console. There is no volume control on the console. The volume must be controlled on the Audio Source.

Quick Start

This is the quickest way to start a workout. After the console powers up you just press the **Start** key to begin, this will initiate the Quick Start mode. In Quick Start the Time will count up from zero and the workload may be adjusted manually by pressing the **Level Up / Down** buttons. The dot matrix display will have only the bottom row lit at first. As you increase the work load more rows will light indicating a harder workout. The fitness bike will get harder to pedal as the rows increase.

There are 20 levels of resistance available for plenty of variety. The first 5 levels are very easy workloads and the changes between levels are set to a good progression for de-conditioned users. Levels 6-10 are more challenging, but the increases in resistance from one level to the next remain small. Levels 11-15 start getting tough as the levels jump more dramatically. Levels 16-20 are extremely hard and are good for short interval peaks and elite athletic training.

Muscle Activation Figure

There is an anatomical figure located to the left of the console. This figure will light all areas that are activated when using the bike. These will light up during any of the programs. You can control which muscles are activated by customizing the resistance profile during the set up phase of console programming. If you accept the default program profile, the selected program will determine which muscles will be activated by automatically adjusting the resistance.

Generally the following guidelines hold true:

- The upper body LED's will not light
- The lower body lights will activate in three degrees of engagement: Green represents minimal muscle involvement, yellow represents medium involvement, and red represents full or heavy activation.
- These are the different scenarios for lower body muscle activation:
 - Levels 1-10: Green – Hamstrings & Gluteals light up; Amber – Quadriceps & Calves light up
 - Levels 11-20: Amber – Hamstrings & Gluteals light up; Red Quadriceps & Calves light up

Heart Rate % Profile

The console LCD screen will display your current heart rate anytime a pulse is detected. The Bar Graph, located to the right of the LCD screen, will show your current heart rate % in relation to your projected maximum heart rate, which is determined by your age that you entered during the programming phase of any of the 10 programs. The significance of the bar graph colors are as follows:

- 50-60% of maximum is Amber
- 65-80% of maximum is Amber and Green
- 85-90% or more is Amber, Green, and Red

Basic Information

The Message Center will initially be displaying the Program name. When in scan mode during a program, speed will be displayed for four seconds, then move on and display Watts (indication of workload). If 100 watts is displayed, you are doing enough work to keep a 100-watt light bulb lit. The data changes to Laps completed, Segment time, Max level. Pressing the Enter button again will bring you back to the beginning.

The Stop button actually has several functions. Pressing the Stop key once during a program will pause the program for 5 minutes. If you need to get a drink, answer the phone or any of the many things that could interrupt your workout, this is a great feature. To resume your workout during Pause, just press the Start key. If the Stop button is pressed twice during a workout, the program will end and the console will display your Workout Summary (Total time, Avg. Speed, Avg. Watts, Avg. HR, total Laps). If the Stop key is held down for 3 seconds or a third time during the program, the console will perform a complete Reset. During data entry for a program the Stop key performs a previous screen or segment function. This allows you to go back to change programming data.

Program Keys

The Program Keys are used to preview each program. When you first turn the console on you may press each program key to preview what the program profile looks like. If you decide that you want to try a program, press the corresponding program key and then press the Enter key to select the program and enter into the data-setting mode.

The fitness bike has a built in heart rate monitoring system. Simply grasping the hand pulse sensors on the stationary handle bars or wearing the heart rate transmitter (see Using Heart Rate Transmitter section) will start the Heart Icon blinking (this may take a few seconds). The Pulse Display Window will display your heart rate, or Pulse in beats per minute.

The console includes a built-in fan to help keep you cool. To turn the fan on, press the button on the left side of the console.

Programming The Console

Each of the programs can be customized with your personal information and changed to suit your needs. Some of the information asked for is necessary to ensure the readouts are correct. You will be asked for your Age and Weight. Entering your Age is necessary during the Heart Rate programs to ensure the correct settings are in the program for your Age. Otherwise the work settings could be too we cannot provide an exact calorie count, we do want to be as close as possible.

CALORIE NOTE: Calorie readings on every piece of exercise equipment, whether it is in a gym or at home, are not accurate and tend to vary widely. They are meant only as a guide to monitor your progress from workout to workout. The only way to measure your calorie burn accurately is in a clinical setting connected to a host of machines. This is because every person is different and burns calories at a different rate. Some good news is that you will continue to burn calories at an accelerated rate for at least an hour after you have finished exercising!

Entering A Program & Changing Settings

When you enter a program, by pressing a program key, then Enter key, you have the option of entering your own personal settings. If you want to work out without entering new settings, then just press the Start key. This will bypass the programming of data and take you directly to the start of your workout. If you want to change the personal settings then just follow the instructions in the Message Center. If you start a program without changing the settings, the default or saved settings will be used.

NOTE: Age and Weight default settings will change when you enter a new number. So the last Age and Weight entered will be saved as the new default settings. If you enter your Age and Weight the first time you use the fitness bike, you will not have to enter it every time you work out unless either your Age or Weight changes or someone else enters a different Age and Weight.

USING THE SPIRIT FIT APP

In order to help you achieve your exercise goals, your new exercise machine comes equipped with a Bluetooth® transceiver that will allow it to interact with selected phones or tablet computers via the Spirit Fit App.

Just download the free Spirit Fit App from the Apple Store or Google Play, and then follow the instructions in the App to sync with your exercise machine. Now you can view current workout data in three different Display screens on your device. You can also easily switch back and forth from the workout display view to internet/social media/email sites via icons on the display screen. When your workout is finished, the data is automatically saved to the built-in personal calendar for future reference.

The Spirit Fit App also allows you to sync your workout data with one of many fitness cloud sites we support: iHealth, MapMyFitness, Record or Fitbit, with more to come.

Syncing the App with your exercise machine:

1. Download the App.
2. Open the App on your device (phone or tablet) and make sure Bluetooth® is enabled on your device (phone or tablet).
3. In the App click the icon in the top left corner to search for your Spirit equipment (shown right).

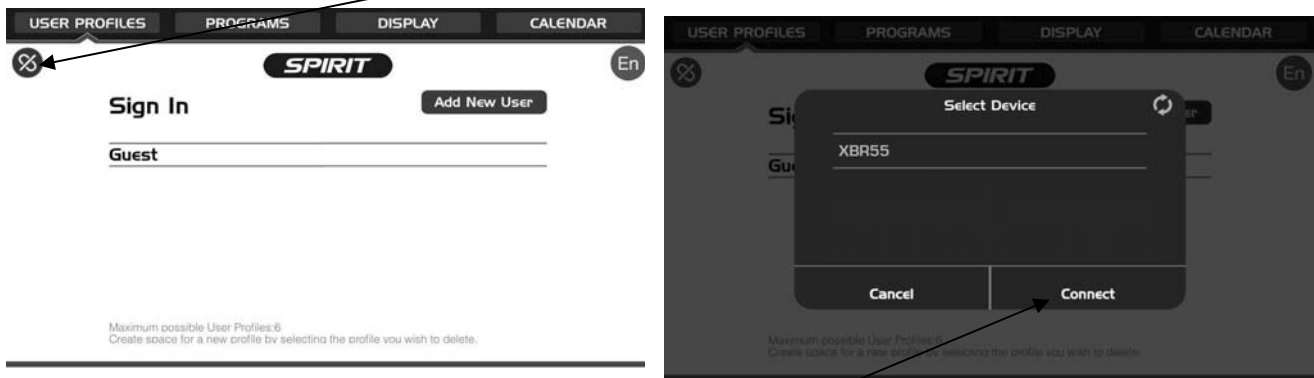

4. After the equipment is detected, click Connect. When the App and equipment are synced, the Bluetooth® icon on the equipment's console display will light up. You may now start using your new Spirit Fitness product.
5. When your workout is finished, the data is automatically saved and you will be prompted to sync your data with each available fitness cloud site. Please note you will have to download the applicable compatible fitness App, such as iHealth, MapMyFitness, Record, Fitbit, etc, in order for the icon to be active and available.

***Note: Your device will need to be running on a minimum operating system of iOS 7 or Android 4.4 for the Spirit Fit App to operate properly.**

PROGRAMMABLE FEATURES

MANUAL

The Manual program works as the name implies, manually. This means that you control the workload and not the computer. To start the Manual program, follow the instructions below or just press the Manual button, then the Enter button and follow the directions in the Message Center.

1. Press the Manual key, then press the Enter key.
2. The Message Center will ask you to enter your Age. You may enter your age, using the Level Up/Down keys, then press the Enter key to accept the new value and proceed on to the next screen.
3. You are now asked to enter your Weight. You may adjust the Weight value using the Level Up/Down keys, then press Enter to continue.
4. Next is Time. You may adjust the Time and press Enter to continue.
5. Now you are finished editing the settings and can begin your workout by pressing the Start key. You can also go back and modify your settings by pressing the Enter key.
6. Once the program starts you will be at level one. This is the easiest level and it is a good idea to stay at level one for a while to warm up. If you want to increase the work load at any time press the Level Up key; the Level Down key will decrease the work-load.
7. During the Manual program you will be able to scroll through the data in the Message Center by pressing the Enter key.
8. When the program ends you may press Start to begin the same program again or Stop to exit the program or you can save the program you just completed as a custom user program by pressing a User key and following the instructions in the Message Center.

PRESET PROGRAMS

The Semi - Recumbent Bike has five different programs that have been designed for a variety of workouts. These five programs have factory preset work level profiles for achieving different goals.

HILL

This program follows a triangle or pyramid type of gradual progression from approximately 10% of maximum effort (the level that you chose before starting this program) up to a maximum effort which lasts for 10% of the total workout time, then a gradual regression of resistance back to approximately 10% of maximum effort.

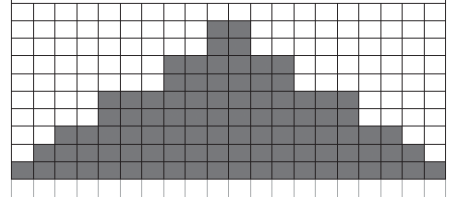

FAT BURN

This program follows a quick progression up to the maximum Resistance level (default or user input level) that is sustained for 2/3 of the workout. This program will challenge your ability to sustain your energy output for an extended period of time.

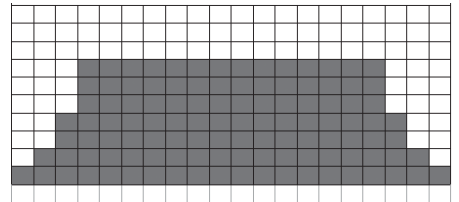

CARDIO

This program presents a quick progression up to near maximum resistance level (default or user input level). It has slight fluctuations up and down to allow your heart rate to elevate, and then recover repeatedly, before beginning a quick cool down. This will build up your heart muscle and increase blood flow and lung capacity.

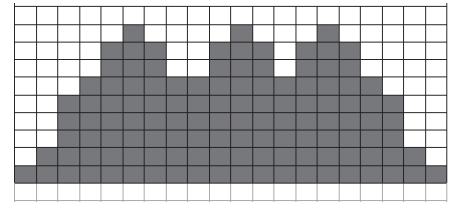

STRENGTH

Resistance: This program has a gradual progression of resistance up to 100% of maximum effort that is sustained for 25% of workout duration. This will help build strength and muscular endurance in the lower body and glutes. A brief cool down follows.

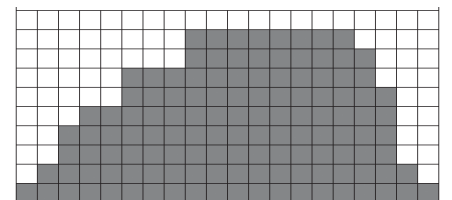

INTERVAL

This program takes you through high levels of intensity followed by recovery periods of low intensity. This program utilizes and develops your “Fast Twitch” muscle fibers which are used when performing tasks that are intense and short in duration. These deplete your oxygen level and spike your heart rate, followed by periods of recovery and heart rate drop to replenish oxygen. Your cardiovascular system gets programmed to use oxygen more efficiently.

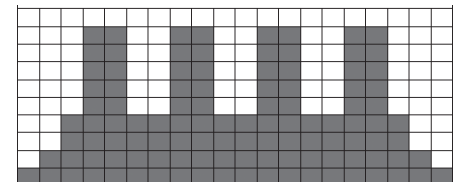

PROGRAMMING PRESET PROGRAMS

1. Select the desired program button then press the **Enter** key.
2. The **Message Center** will ask you to enter your Age. You may adjust the age setting, using the **Up** and **Down** keys, then press the **Enter** key to accept the new number and proceed on to the next screen.
3. You are now asked to enter your **Weight**. You may adjust the weight number using the **Up** and **Down** keys, then press **Enter** to continue.
4. Next is **Time**. You may adjust the **Time** and press **Enter** to continue.
5. Now you are asked to adjust the **Max Resistance Level**. This is the peak exertion level you will experience during the program (at the top of the hill). Adjust the level and then press **Enter**.
6. Now you are finished editing the settings and can begin your workout by pressing the **Start** key. You can also go back and modify your settings by pressing the **Enter** key to go back one level, or screen.
7. If you want to increase or decrease the workload at any time during the program press the **Up** or **Down** key. This will change the resistance settings of the entire profile, although the profile picture on the screen will not change. The reason for this is so that you can see the entire profile at all times. If the profile picture is changed, it also would be distorted and not a true representation of the actual profile. When you make a change to the resistance, the Message Center will show the current column and program maximum levels of work.
8. During the program you will be able to scroll through the data in the **Message Center** the message Center by pressing the **Enter** key.
9. When the program ends the **Message Center** will show a summary of your workout. The summary will be displayed for a short time then the console will return to the start-up display.

CUSTOM USER DEFINED PROGRAMS

There are two customizable User programs that allow you to build and save your own workout. The two programs, **User 1** and **User 2**, operate exactly the same way so there is no reason to describe them separately. You can build your own custom program by following the instructions below or you can save any other preset program you complete as a custom program. Both programs allow you to further personalize it by adding your name.

1. Select the **User program (U1 or U2)** then press **Enter**. If you have already saved a program to either **U1** or **U2**, it will be displayed and you are ready to begin. If not, you will have the option of inputting a username. In the Message Center, the letter "A" will be blinking. Use the **Level Up/Down** buttons to select the appropriate first letter of your name (pressing the **Level Up** button will switch to the letter "B"; pressing the **Down** button will switch to letter "Z"). Press **Enter** when the desired letter is displayed. Repeat this process until all of the characters of your name have been programmed (maximum 7 characters). When finished press **Stop**.
2. If there is a program already stored in User when you press the key, you will have an option to run the program as it is or delete the program and build a new one. At the welcome message screen, when pressing **Start** or **Enter** you will be prompted: Run Program? Use the **Level Up/Down** to select Yes or No. If you select No, you will then be asked if you want to delete the currently saved program. It is necessary to delete the current program if you want to build a new one.
3. The Message Center will ask you to enter your **Age**. You may enter your age, using the **Level Up/Down** keys, then press the **Enter** key to accept the new value and proceed on to the next screen.
4. You are now asked to enter your **Weight**. You may adjust the weight value using the **Level Up/Down** keys or the numeric key pad, then press **Enter** to continue.
5. Next is **Time**. You may adjust the time and press **Enter** to continue.
6. Now you are asked to adjust the Max Resistance Level of the program, press **Enter** when resistance has been selected.
7. Now the first column will be blinking and you are asked to adjust the resistance level for the first segment (SEGMENT> 1) of the workout by using the **Level Up/Down** key. When you finish adjusting the first segment, or if you don't want to change, then press **Enter** to continue to the next segment.
8. The next segment will show the same workload resistance level as the previously adjusted segment. Repeat the same process as the last segment then press **Enter**. Continue this process until all twenty segments have been set.
9. The Message Center will then tell you to press **Enter** to save the program. After saving the program the Message Center says "program saved" then will give you the option to start or modify the program. Pressing **Stop** will exit to the start up screen.

HEART RATE PROGRAMS

The old motto, “no pain, no gain”, is a myth that has been overpowered by the benefits of exercising comfortably. A great deal of this success has been promoted by the use of heart rate monitors. With the proper use of a heart rate monitor, many people find that their usual choice of exercise intensity was either too high or too low and exercise is much more enjoyable by maintaining their heart rate in the desired benefit range.

To determine the benefit range in which you wish to train, you must first determine your Maximum Heart Rate. This can be accomplished by using the following formula: 220 minus your age. This will give you the Maximum Heart Rate (MHR) for someone of your age. To determine the effective heart rate range for specific goals you simply calculate a percentage of your MHR. Your Heart rate training zone is 50% to 90% of your maximum heart rate. 60% of your MHR is the zone that burns fat while 80% is for strengthening the cardio vascular system. This 60% to 80% is the zone to stay in for maximum benefit.

For someone who is 40 years old their target heart rate zone is calculated:

$$220 - 40 = 180 \text{ (maximum heart rate)}$$
$$180 \times .6 = 108 \text{ beats per minute}$$

(60% of maximum)

$$180 \times .8 = 144 \text{ beats per minute}$$

(80% of maximum)

So for a 40 year old the training zone would be 108 to 144 beats per minute.

If you enter your age during programming the console will perform this calculation automatically. Entering your age is used for the Heart Rate programs. After calculating your MHR you can decide upon which goal you would like to pursue.

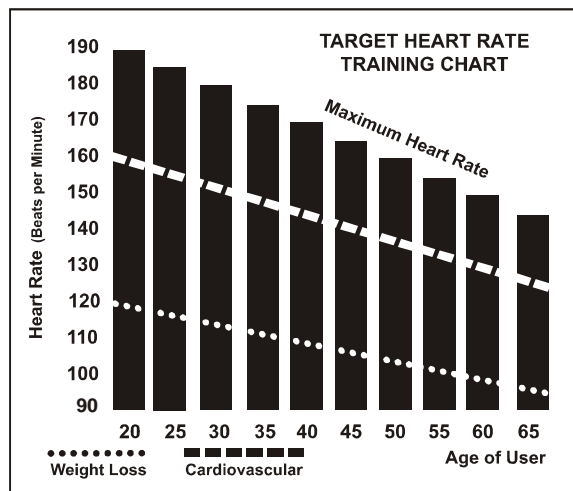

The two most popular reasons for, or goals, of exercise are cardiovascular fitness (training for the heart and lungs) and weight control. The black columns on the chart above represent the MHR for a person whose age is listed at the bottom of each column. The training heart rate, for either cardiovascular fitness or weight loss, is represented by two different lines that cut diagonally through the chart. A definition of the lines' goal is in the bottom left-hand corner of the chart. If your goal is cardiovascular fitness or if it is weight loss, it can be achieved by training at 80% or 60% respectively, of your MHR on a schedule approved by your physician. Consult your physician before participating in any exercise program.

RATE OF PERCEIVED EXERTION

Heart rate is important but listening to your body also has a lot of advantages. There are more variables involved in how hard you should workout than just heart rate. Your stress level, physical health, emotional health, temperature, humidity, the time of day, the last time you ate and what you ate, all contribute to the intensity at which you should workout. If you listen to your body, it will tell you all of these things.

The rate of perceived exertion (RPE), also know as the Borg scale, was developed by Swedish physiologist G.A.V. Borg. This scale rates exercise intensity from 6 to 20 depending upon how you feel or the perception of your effort.

The scale is as follows:

Rating Perception of Effort

- 6 Minimal
- 7 Very, very light
- 8 Very, very light +
- 9 Very light
- 10 Very light +
- 11 Fairly light
- 12 Comfortable
- 13 Somewhat hard
- 14 Somewhat hard +
- 15 Hard
- 16 Hard +
- 17 Very hard
- 18 Very hard +
- 19 Very, very hard
- 20 Maximal

You can get an approximate heart rate level for each rating by simply adding a zero to each rating. For example a rating of 12 will result in an approximate heart rate of 120 beats per minute. Your RPE will vary depending up the factors discussed earlier. That is the major benefit of this type of training. If your body is strong and rested, you will feel strong and your pace will feel easier. When your body is in this condition, you are able to train harder and the RPE will support this. If you are feeling tired and sluggish, it is because your body needs a break. In this condition, your pace will feel harder. Again, this will show up in your RPE and you will train at the proper level for that day.

USING HEART RATE TRANSMITTER

How to wear your wireless chest strap transmitter:

1. Attach the transmitter to the elastic strap using the locking parts.
2. Adjust the strap as tightly as possible as long as the strap is not too tight to remain comfortable.
3. Position the transmitter with the logo centered in the middle of your torso facing away from your chest (some people must position the transmitter slightly left of center). Attach the final end of the elastic strap by inserting the round end and, using the locking parts, secure the transmitter and strap around your chest.
4. Position the transmitter directly below the pectoral muscles.
5. Sweat is the best conductor to measure very minute heart beat electrical signals. However, plain water can also be used to pre-wet the electrodes (2 ribbed oval areas on the reverse side of the belt and both sides of the transmitter). It's also recommended that you wear the transmitter strap a few minutes before your workout. Some users, because of body chemistry, have a more difficult time in achieving a strong, steady signal at the beginning. After "warming up", this problem lessens. As noted, wearing clothing over the transmitter/strap doesn't affect performance.
6. Your workout must be within range - distance between transmitter/receiver – to achieve a strong steady signal. The length of range may vary somewhat but generally stay close enough to the console to maintain good, strong, reliable readings. Wearing the transmitter directly on bare skin assures you of proper operation. If you wish, you may wear the transmitter over a shirt. To do so, wet the areas of the shirt that the electrodes will rest upon.

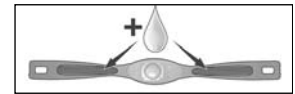

Note: The transmitter is automatically activated when it detects activity from the user's heart. Additionally, it automatically deactivates when it does not receive any activity. Although the transmitter is water resistant, moisture can have the effect of creating false signals, so you should take precautions to completely dry the transmitter after use to prolong battery life (estimated transmitter battery life is 2500 hours). The replacement battery is Panasonic CR2032.

ERRATIC OPERATION

Caution! Do not use this Semi - Recumbent Bike for Heart Rate programs unless a steady, solid Actual Heart Rate value is being displayed. High, wild, random numbers being displayed indicate a problem. Areas to look for interference which may cause erratic heart rate:

1. Microwave ovens, TV's, small appliances, etc.
2. Fluorescent lights.
3. Some household security systems.
4. Perimeter fence for a pet.
5. Some people have problems with the transmitter picking up a signal from their skin. If you have problems try wearing the transmitter upside down. Normally the transmitter will be oriented so the Spirit Fitness logo is right side up.
6. The antenna that picks up your heart rate is very sensitive. If there is an outside noise source, turning the whole machine 90 degrees may de-tune the interference.
7. Another Individual wearing a transmitter within 3' of your machine's console.

If you continue to experience problems contact your dealer.

HEART RATE PROGRAM OPERATION

Note: You must wear the heart rate transmitter strap for these programs

Both programs operate the same, the only difference is that **HR1** is set to 60% and **HR2** is set to 80% of the maximum heart rate. They both are programmed the same way. To start an HR program follow the instructions below or just select the **HR1** or **HR2** program, then the **Enter** button and follow the directions in the Message Center.

After selecting your heart rate target the program will attempt to keep you at or within 3-5 heart beats per minute of this value. Follow the prompts in the Message Center to maintain your selected heart rate value.

1. Press the **HR 1** or **HR 2** key then press the **Enter** key.
2. The Message Center will ask you to enter your Age. You may enter your age, using the **LEVEL + / -** keys, then press the **Enter** key to accept the new value and proceed on to the next screen.
3. You are now asked to enter your Weight. You may adjust the weight value using the **LEVEL + / -** keys, then press **Enter** to continue.
4. Next is Time. You may adjust the time and press **Enter** to continue.
5. Now you are asked to adjust the Heart Rate Target. This is the heart rate level you will strive to maintain during the program. Adjust the level using the **LEVEL + / -** keys, then press **Enter**.

Note: The heart rate that appears is based on the % you accepted in Step 1. If you change this number it will either increase or decrease the % from Step 1.

6. Now you are finished editing the settings and can begin your workout by pressing the **Start** key. You can also go back and modify your settings by pressing the **Enter** key.
*Note: At any time during the editing of Data you can press the **Enter** key to go back one screen.*
7. If you want to increase or decrease the workload at any time during the program press the **LEVEL + / -** key. This will allow you to change your target heart rate at any time during the program.
8. During the HR 1 or HR 2 programs you will be able to scroll through the data in the Message Center by pressing the **Enter** key.
9. When the program ends you may press **Start** to begin the same program again or **Stop** to exit the program.

PARTS LIST

KEY NO.	PART NO.	DESCRIPTION	Q'TY
1	6835501	Main Frame	1
2	6835502	Console Mast	1
3	6835503	Mast Handlebar Assembly	1
4	6835504	Seat Carriage	1
5	6835505	Back Rest	1
6	6835506	Seat Handle Bar	1
7	6835507	Rear Stabilizer	1
8	6835508	Crank Axle	1
9L	6835509L	Seat Wheel Adjustment Plate (L)	2
9R	6835509R	Seat Wheel Adjustment Plate (R)	2
10	6835510	Idler Wheel Assembly	1
11	6835511	Seat Stop Axle	2
12	6835512	Seat Position Latch	1
13	6835513	Backing Plate	3
14	6835514	Aluminum Track	1
15	6835515	Rack	1
16	6835516	Spacer for Stopper Axle	4
17	6835517	Rubber Foot	4
18	6835518	Transportation Wheel	2
19	6835519	Console Assembly	1
19~1	6835519-1	Console Top Cover	1
19~2	6835519-2	Console Bottom Cover	1
19~3	6835519-3	Book Rack	1
19~4	6835519-4	Deflector Fan Grill	1
19~5	6835519-5	Deflector Fan Grill	1
19~6	6835519-6	Wind Duct (R)	1
19~7	6835519-7	Wind Duct (L)	1
19~8	6835519-8	Water-resist Rubber	1
19~9	6835519-9	Fan Grill Anchor	2
19~10	6835519-10	LCD Transparent Piece	1
19~11	6835519-11	Speaker Grill Anchor	6
19~12	6835519-12	Fan Grill Anchor	2
19~13	6835519-13	Fan Assembly	1
19~14	6835519-14	Console Display Board	1
19~15	6835519-15	Key Board	1

KEY NO.	PART NO.	DESCRIPTION	Q'TY
19~16	6835519-16	Interface Board	1
19~17	6835519-17	300m/m_W/Receiver, HR	1
19~18	6835519-18	300m/m_Speaker W/Cable	2
19~19	6835519-19	Amplifier	1
19~20	6835519-20	Earphone socket w/cable & securing metal	1
19~21	6835519-21	250m/m_Amplifier Cable	1
19~22	6835519-22	Bluetooth	1
20	6835520	Drive Pulley	1
24	6835524	Button Head Plug	2
25	6835525	Seat Track Wheel	8
26	6835526	300m/m_Hand Pulse Sensor Assembly W/Cable	1
26~1	6835526-1	300m/m_Hand Pulse Sensor Assembly W/Cable(White)	1
27	6835527	750m/m_Handpulse W/Cable Assembly(L)	1
27~1	6835527-1	950m/m_Handpulse W/Cable Assembly(R)	1
28	6835528	Crank Arm End Cap	2
29	6835529	Front Shroud (L)	1
30	6835530	Front Shroud (R)	1
31	6835531	Console Mast Cover	1
32	6835532	End Cap	4
33	6835533	Bottom Cover	1
34	6835534	Round Disk Cover	2
35	6835535	Rear Shroud (L)	1
36	6835536	Rear Shroud (R)	1
38	6835538	Drink Bottle Holder (R)	1
39	6835539	Drink Bottle Holder (L)	1
40	6835540	Release Lever	1
41	6835541	Transformer Power Cord	1
43	6835543	Gear Motor	1
44	6835544	750m/m_Computer Cable	1
45	6835545	2100m/m_Hand Pulse Sensor Assembly W/Cable	1
46	6835546	250m/m_Sensor W/Cable	1
48	6835548	750m/m_DC Power Cord	1
51L	6835551L	Crank Arm(L)	1
51R	6835551R	Crank Arm(R)	1
52	6835552	6004_Bearing	2
53	6835553	6203_Bearing	2

KEY NO.	PART NO.	DESCRIPTION	Q'TY
54	6835554	Drive Belt	1
55	6835555	Flywheel	1
56	6835556	Magnet	1
57	6835557	Gas Cylinder	1
58	6835558	Steel Cable(280L)	1
61	6835561	Seat	1
62	6835562	Steel Cable	1
63	6835563	Mesh Seat Back	1
64	6835564	Handgrip Foam	2
65	6835565	3/8" x 53m/m_Carriage Bolt	2
66	6835566	1/4" x 3/4" _Hex Head Bolt	4
67	6835567	3/8" x UNC16 x 4" _Hex Head Bolt	2
68	6835568	5/16" x UNC18 x 5/8" _Hex Head Bolt	8
69	6835569	5/16" x 2- 1/2" _Hex Head Bolt	1
70	6835570	5/16" x UNC18 x 1-1/4" _Hex Head Bolt	1
71	6835571	3/8" x 1-3/4" _Hex Head Bolt	4
72	6835572	Ø1/4" x 13 x 1T _Flat Washer	5
73	6835573	Ø1/4" x 19 x 1.5T _Flat Washer	4
75	6835575	Ø17 x Ø23.5 x 1T _Flat Washer	1
76	6835576	Ø5/16" x Ø18 x 1.5T _Flat Washer	10
77	6835577	Ø3/8" x Ø19 x 1.5T _Flat Washer	9
79	6835579	Ø8 x Ø18 x 3T _Knurled Lock Washer	4
81	6835581	3/8" x 3/4" _Button Head Socket Bolt	1
82	6835582	5/16" x 1.5T _Split Washer	8
83	6835583	5/16" x 19 x 1.5T _Curved Washer	2
84	6835584	Ø3/8" x Ø25 x 2T _Flat Washer	2
85	6835585	Ø17 _C Ring	1
86	6835586	Ø20 _C Ring	2
87	6835587	M8 x 130m/m _J Bolt	1
88	6835588	M8 x 7T _Nyloc Nut	5
89	6835589	3/8" x 7T _Nyloc Nut	7
90	6835590	1/4" x 8T _Nyloc Nut	4
91	6835591	5/16" x 6T _Nyloc Nut	6
93	6835593	M6 x 38m/m _Socket Head Cap Bolt (Alloy Steel)	1
94	6835594	5/16" x UNC18 x 3/4" _Hex Head Bolt	6
95	6835595	M5 x 12m/m _Flat Head Socket Screw	10

KEY NO.	PART NO.	DESCRIPTION	Q'TY
97	6835597	3 x 20m/m_Tapping Screw	4
98	6835598	M6 x 15m/m_Phillips Head Screw	8
99	6835599	M5 x 12m/m_Phillips Head Screw	13
101	68355101	Ø5 x 16m/m_Tapping Screw	10
103	68355103	3.5 x 16m/m_Sheet Metal Screw	12
104	68355104	Spring	1
105	68355105	Ø4 x 16m/m_Sheet Metal Screw	4
106	68355106	5/16" x UNC18 x 1-3/4"_Button Head Socket Bolt	2
108	68355108	M10 x 1.25m/m_Nut	2
109	68355109	3/8" x 7T_Nut	8
110	68355110	3/8" x 2"_Flat Head Socket Bolt	4
111	68355111	M5 x P0.8 x 10L_Flat Phillips Head Screw	8
112	68355112	12/14m/m_Wrench	1
113	68355113	13/15m/m_Wrench	1
114	68355114	Phillips Head Screwdriver	1
116	68355116	Pedal (L)	1
117	68355117	Pedal (R)	1
119	68355119	3/8"-UNF26 x 3T_Nut	1
120	68355120	3/8"-UNF26 x 4T_Nut	1
121	68355121	3/8"-UNF26_Nut	2
122	68355122	Drink Bottle	1
123	68355123	Chest Strap	1
125	68355125	Seat Carriage Cover	1
126	68355126	HGP Wire Grommet	1
129	68355129	M6 x 6T_Nyloc Nut	1
130	68355130	13/14m/m_Wrench	1
131	68355131	Power Adaptor	1
140	68355140	Sensor Rack	1
141	68355141	Handle Bar Cover	1
143	68355143	Seat Track Fixing Plate	1
144	68355144	Handgrip End Cap	2
145	68355145	Resistance Button W/Cable	2
146	68355146	Handgrip Resistance Label (UP)	1
147	68355147	Handgrip Resistance Label (DOWN)	1
148	68355148	2100m/m_Handlebar Resistance Control Cable	1
149	68355149	300m/m_Handle Switch Bracket	1

KEY NO.	PART NO.	DESCRIPTION	Q'TY
150	68355150	180m/m_Resistance Connecting Cable	1
151	68355151	Switch Cable (Lower)	1
152	68355152	400m/m_Audio Cable	1
153	68355153	Console Holder Assembly	1
154	68355154	5/16" x 2-1/2"_Hex Head Bolt	1
157	68355157	5/16" x 25 x 3T_ Nylon Washer	2
160	68355160	Ø5/16" x 16 x 1.5T_Flat Washer	6
161	68355161	M6 x 10L_Flat Phillips Head Screw	4
162	68355162	Ø1/4" x Ø16 x 1.0T_Flat Washer	4
163	68355163	Sleeve	4
164	68355164	M6 x 19L_Nut	4
165	68355165	M6 x 10L_Button Head Socket Bolt	4
166	68355166	PU Wheel	4
167	68355167	Seat Front/Aft Adjustment Lever	1
168	68355168	Lever Anchor	1
169	68355169	M5 x 25m/m_ Flat Head Socket Screw	2
170	68355170	Ø15 x Ø6 x 4T_Nylon Washer	1
171	68355171	M5 x 45m/m_Socket Head Cap Bolt	1
172	68355172	Ø5 x Ø10 x 1.0T_Flat Washer	1
173	68355173	M5 x 5T_Nyloc Nut	2
177	68355177	Rubber Foot Pad	1
184	68355184	Ø13 x Ø23 x 3T_Nylon Washer	1
185	68355185	3/8" x 4T_Nut	1
186	68355186	ChenChin Torsion-Spring	1
187	68355187	M5 x P0.8 x 20L_Phillips Head Screw	1
188	68355188	5/16" x UNC18 x 1-1/2"_Hex Head Bolt	1
189	68355189	Rubber Pad	1
191	68355191	3/8" x UNC16 x 12.5T_Cap Nut	2

GENERAL MAINTENANCE

1. Wipe down all areas in the sweat path with a damp cloth after each workout.
2. If a squeak, thump, clicking or rough feeling develops the main cause is most likely one of two reasons:
 - I. The hardware was not sufficiently tightened during assembly. All bolts that were installed during assembly need to be tightened as much as possible. It may be necessary to use a larger wrench than the one provided if you cannot tighten the bolts sufficiently. I cannot stress this point enough; 90% of calls to the service department for noise issues can be traced to loose hardware.
 - II. The crank arm nut needs to be retightened
 - III. If squeaks or other noises persist, check that the unit is properly leveled. There are 2 leveling pads on the bottom of the rear stabilizer, use a 14mm wrench (or adjustable wrench) to adjust the levelers.

ENGINEERING MODE MENU

The console has built in maintenance/diagnostic software. The software will allow you to change the console settings from English to Metric and turn off the beeping of the speaker when a key is pressed for example. To enter the Engineering Mode Menu, press and hold down the **Start**, **Stop** and **Enter** keys. Keep holding the keys down for about 5 seconds and the Message Center will display Engineering Mode Menu. Press the **Enter** button to access the menu below:

- a. **Key Test** (Will allow you to test all the keys to make sure they are functioning)
- b. **LCD Test** (Tests all the display functions)
- c. **Functions** (Press **Enter** to access settings and **+** arrow to scroll)
 - i. **Display Mode** (Turn off to have the console power down automatically after 20 minutes of inactivity)
 - ii. **Pause Mode** (Turn on allow 5 minutes of pause, turn off to have the console pause indefinitely)
 - iii. **ODO Reset** (Resets the odometer)
 - iv. **Units** (Sets the display to readout in English or Metric display measurements)
 - v. **Beep** (Turns off the speaker so no beeping sound is heard)
 - vi. **Motor test** (Continually runs the tensioning gear motor)
 - vii. **Safety**
- d. **Security** (Allows the keypad to be locked to prevent unauthorized use)

Manufacturer's Limited Warranty

Dyaco Canada Inc. warrants all its bike parts for a period of time listed below, from the date of retail sale, as determined by a sales receipt. Dyaco Canada Inc.'s responsibilities include providing new or remanufactured parts, at Dyaco Canada Inc.'s option, and technical support to our independent dealers and servicing organizations. In the absence of a dealer or service organization, these warranties will be administered by Dyaco Canada Inc. directly to a consumer. The warranty period applies to the following components:

Home Warranty	
Frame	Lifetime
Brake	Lifetime
Parts	10 Years
Labour	1 Year

This warranty is not transferable and is extended only to the original owner.

The warranty shall not apply to exercise units which are (1) used for commercial or other income producing purposes, or (2) subject to misuse, neglect, accident or unauthorized repair and alterations.

This warranty provided herein is lieu of all other express warranties, any implied warranties, including any implied warranties of merchantability of fitness for particular purpose, are limited in duration to the first 12 months from date of purchase. All other obligations or liabilities, including liability for consequential damages are hereby excluded.

REPAIR PARTS AND SERVICE

All of the parts for the Spirit cycle shown in figure can be ordered from Dyaco Canada Inc. 5955 Don Murie Street, Niagara Falls, Ontario L2G 0A9. When ordering parts, the parts will be sent and billed at the current prices. Prices may be subject to change without notice. Check or money order must accompany all orders. Standard hardware items are available at your local hardware store.

To ensure prompt and correct handling of any errors, or to answer any questions, please call our Toll Free number: 1-888-707-1880, or local number 1-905-353-8955 or fax 1-905-353-8968, email customerservice@dyaco.ca or visit our website at www.dyaco.ca. Office hours are from 8:30 AM to 5:00 PM Monday to Friday Eastern Standard Time.

Always include the following information when ordering parts

- Model number
- Name of each part
- Part number of each part



Please visit us online for information about our other brands and products manufactured and distributed by Dyaco Canada Inc.



www.dyaco.ca



www.dyaco.ca



www.dyaco.ca



www.dyaco.ca



www.spiritfitnesscanada.ca
www.dyaco.ca



www.spiritfitnesscanada.ca
www.dyaco.ca



www.solefitness.ca
www.dyaco.ca



www.trainorsports.ca
www.dyaco.ca



www.xterrafitness.ca
www.dyaco.ca